

# ROBERT KITTO

## *Lighting*

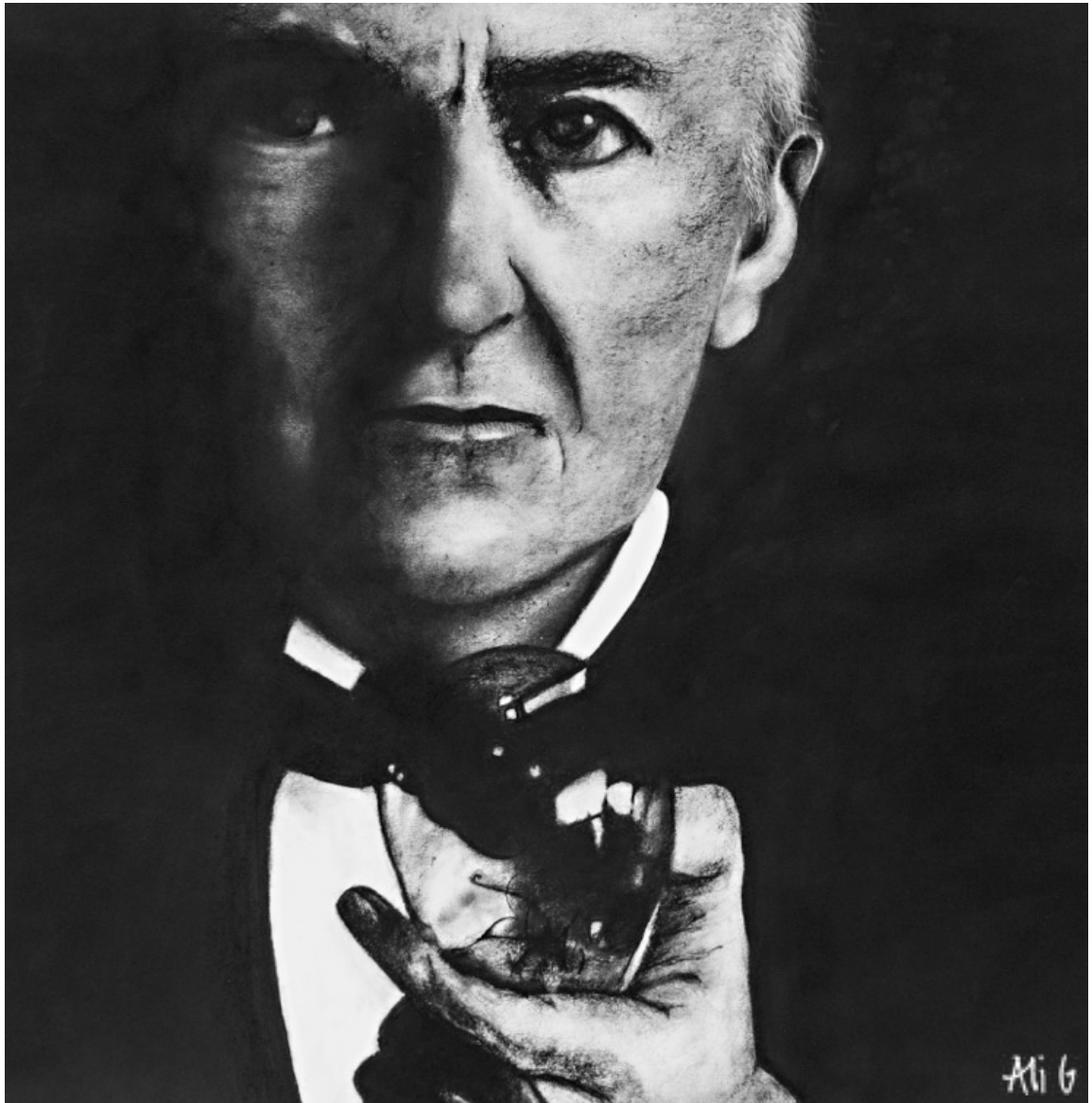

Original artwork of Thomas Edison with globe.  
By Alexandra Galbraith, © 2018 All Rights Reserved

This image or any replica of it may not be copied, manipulated, used or reproduced  
in any way without express permission of the owner, Alexandra Galbraith.

## Table of contents:

Foreword	Page 5
Product Disclaimer	Page 6
Metalware Finishes	Page 7
<b>LAMPS</b>	
- Table Lights	Page 10 - 31
- Floor Stanards	Page 32 - 35
<b>WALL LIGHTING</b>	
- Lanterns	Page 36 - 41
- Brackets	Page 42 - 79
<b>ACCESSORIES</b>	
- Shades	Page 80 - 119
- Parts, Globes & Flush fittings	Page 120 - 143
<b>CEILING LIGHTS</b>	
- Suspensions	Page 144 - 197
- Float Lamps	Page 198 - 203
- Lanterns	Page 204 - 231
- Pendants	Page 232 - 283
Glossary	Page 296 - 297
Freight Information	Page 298
Terms and Conditions	Page 299 - 300
Privacy Policy	Page 301 - 302

## FOREWORD

It is with great pleasure that I announce our 6<sup>th</sup> Edition of 'Catalogue of Lighting' in 2019.

Robert Kitto Lighting is continuously working on adding new fittings to our already extensive range. You may have already seen some of these lights, however, many of our fittings have been created recently, and we are proud to give them the attention they deserve, alongside some of our classics like the Frome pendant and wall bracket.

Robert Kitto's aim is to provide the best quality residential light fittings in the country. In doing so we focus on a combination of custom in house assembly, hand finished to order, by our selected team of skilled craftsmen.

We also offer a select range of imported fittings, pre-assembled ready to ship, built by companies who uphold similar values of skilled craftsmanship and quality materials. I sincerely hope you enjoy browsing the pages of this 6<sup>th</sup> edition of our catalogue.



Henry Kitto  
*Henry Kitto*  
Managing Director

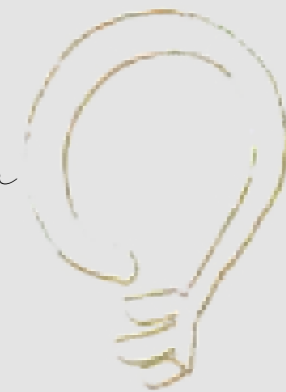



## READ FIRST

Check the dimensions before you order, Your fitting will be made to order, so it is essential the right model and finish are chosen. It is unlikely you will be able to cancel, exchange or refund your order once production has commenced. We will not restock products which are incorrectly ordered, as in most cases the light you receive is one made especially for you.

Dimensions, Sizing and Proportions;

It's important to note that all images Robert Kitto Pty. Ltd. displays, including images on our website, in emails we send, our brochures and all other printed images have not necessarily been created to scale with each other and may not be all in correct proportions. It is your responsibility to check the correct size and shape of fittings before you place your order.

To assist in understanding the shape and size of the fittings we offer, measurements are provided in millimetres. If you ever require more information about a certain product, visit our website or contact us, we will try with our best efforts to explain the shape size, colour and materials which are used in our products.

### WIDTH

The width of the fitting is between the centre of the globe holders without the shade. Shade widths are measured at the widest cross section. (Width in round items is the diameter).

### DEPTH

The depth of a wall bracket or wall lantern is also known as the projection which is measured from the wall to the centre of globe holder, (not including the shade).

### HEIGHT

The height of the fitting from the point where the suspension rod connects to the fitting to the lowest point, this doesn't include the shade height (unless otherwise stated), as the shades are usually your choice. The height of a table lamp or floor lamp is from the base to the globe holder.

### SUSPENSION

The suspension is the diameter x length of tube for rod fittings. e.g. 12.7 x 750, would refer to a suspension 12.7mm in diameter and 750mm in height. (This may be variable, e.g. in counterweight cord suspensions).

### WEIGHT

The gross weight of the fitting in kilograms. This may vary slightly by process and finish. (Weights don't include separate glasses or shades).

*Please note: to get the total height for any given fitting, you will need to sum the suspension with the height, Then the height of the shades chosen may also need to be added to this.*



### Polished Brass (-PB)

A traditional lustrous finish high-lighting the brilliant compound of which our fittings are made from. We carefully polish each piece of brass and coat it in an UV protective, high gloss lacquer, to prevent the finish from ageing.

To maintain polished brass metal, never rub anything abrasive to the surface, and dust lightly with a soft cloth.

### Old Brass (-OB)

An aged effect with character and soul. Old brass metalware is lightly buffed and prepared for treating, which we carefully apply by hand ageing chemicals to give the brass a deep honey coloured texture. The finish varies with each fitting made, not unlike wine vintages, due to different chemical strengths and temperatures. The old brass metalware is unique to each fitting. Also coated in a UV protective, high gloss lacquer, to prevent the finish from changing its appearance from its first days. To maintain old brass metal, never rub anything abrasive to the surface, and dust lightly with a soft cloth.



### Black Bronze (-BB)

A traditional deep dark glossy finish which stands out on smooth surfaces and modestly masks overly decorative designs. The gleam of the chemically treated brass lustres with a coating of UV protective, high gloss lacquer, to prevent the finish from tarnishing or oxidising further.

To maintain bronze finished metal, never rub anything abrasive to the surface, and dust lightly with a soft cloth.

### Antique Bronze (-AB)

An aged effect with character and soul, brass metalware is lightly roughened and prepared for treating, which we carefully apply by hand, with ageing chemicals to give the metal a rich chocolate coloured finish, the finish varies with each fitting made, not unlike wine vintages, due to different chemical strengths and temperatures. Unlike other metalware finishes, antique bronze is not lacquered, allowing the finish to continue to naturally age and patina. To care for antique bronze metal, only lightly dust it. Avoid touching the metalware as there is no lacquer to prevent finger marks. Otherwise allow the fitting to naturally patina.



### Antique Nickel (-AN)

A traditional electroplated finish. We carefully polish each piece of brass, plate it in pearl satin nickel, then carefully and lightly buff the plated metal to highlight the detail in the pieces. This takes away the flat, dull finish and results in a beautiful warm antique finish, which has an excellent balance of lustre and old world feel.

To maintain antique nickel metal, never rub anything abrasive to the surface, and dust lightly with a soft cloth. Antique nickel can occasionally be cleaned with Silvo to refresh the finish.

### Satin Nickel (-SN)

A modern brushed dull effect, designed to enhance sleek lines and smooth contemporary components. Satin Nickel metalware is buffed and prepared for electroplating, which we then sizzle to provide depth to the finish adding the modern brushed lines whilst maintaining the contemporary satin colour. Also coated in a UV protective, high gloss lacquer, to protect the finish and its smooth appearance. To maintain satin nickel metalware, never rub anything abrasive to the surface, and dust lightly with a soft cloth.



### Bright Chrome (-BC)

A modern lustrous finish highlighting in detail the ornateness of decorative castings or the sleek smooth lines of simple pressed pieces. We carefully prepare each piece of brass and have it electroplated in this bright finish. The finish is bonded tightly to the raw material making it extremely durable, hence it is often recommended in humid areas including kitchens and bathrooms. To maintain bright chrome metal, never rub anything abrasive to the surface, and wipe lightly with a soft cloth.

## Lamps

## Wall Lighting

## Wall Lighting

Page 12	Seymour, Kilkenny
Page 13	Christine, Suzanne
Page 14	Isobel, Chatswood, Randwick, Bronte
Page 15	Bellevue, Watson, Waverley
Page 16	Cremorne, Lonsdale
Page 17	Dulwich, Cheltenham
Page 18	Brompton, Elliot
Page 19	Clayton, Lucinda, Loxton
Page 20	Ashbourne, Lyndhurst
Page 21	Lindfield, Killara
Page 22	Beverley, Findon
Page 23	Henley, Kidman
Page 24	Gilberton, Thorngate, Camden
Page 25	Henry, Hamish, Harold
Page 26	Stewart, Harvey,
Page 27	John, Norman, Maxwell
Page 28	Russell, James, George, Philip
Page 29	Annabel, Victoria
Page 30	Monroe, Timothy Lydon, Samuel, Denva
Page 31	Nova, Nelson, Winslow
Page 34	Osmond, Eton, Hamilton
Page 35	Owen, Ferguson, Cheltenham
Page 36	Wall Lanterns

Page 46	Carrington (exterior), Chesser (exterior)
Page 47	Bellmore, Medford
Page 48	Magill, Highgate
Page 49	Magill, St. Louis, Kentish, Mackinnon
Page 50	McLaren
Page 51	Coromandel, Regent, Kew
Page 52	Paddington (exterior), Clarendon (exterior)
Page 53	Hamlet, Vincent
Page 54	Surface Mounts
Page 56	Carrington, Gawler, Leigh, Halifax
Page 57	Grange, Gilles, Gilbert, Hindley, Waymouth
Page 58	Fisher, Pirie, Liverpool
Page 59	Clarendon, Frome, Hindmarsh
Page 60	Killara, Lindfield Walkerville
Page 61	Burnside, Norwood, Hyde
Page 62	Brighton, Glenelg
Page 63	Malvern, Hawthorn, Aldgate
Page 64	Winged Siren, Stratford
Page 65	Juliet, Veneto,
Page 66	Buxton, Millswood
Page 67	Hertfordshire
Page 68	Goodwood, Wayville, Blackwood

Page 69	Mayo, Lincoln
Page 70	Library, Kenton
Page 71	Blackburn
Page 72	Chelsea, Dover, Netherby
Page 73	Glenbrook, Hurtle, Edward
Pages 74	Wall Sconces
Page 76	Twickenham
Page 77	Verandah, Twickenham
Page 78	Whitmore, Wellington
Page 79	Wellington, Woollahra, Vintage
Page 80	Murray, Morgan, Callington



## Ceiling Lighting

Page 246	Plumbing pendants
Page 248	Basket chandeliers
Page 250	Stepped basket
Page 251	Chandelier
Page 252	Rustic chandelier



Page 274	Gilles, Gilbert, Leabrook
Page 275	Grange, Fisher, Liverpool
Page 276	Frome, Hindley, Currie

Page 292	Walkerville, Veneto
Page 293	Verona
Page 294	Winged Siren, Millswood
Page 295	Winged Siren

Page 253	Netherby, Northgate
Page 254	Edward, Dover
Page 255	William
Page 256	Chatham, Clarendon
Page 257	Staten, Brooklyn
Page 258	Murray, Brooklyn
Page 259	Staten, Brooklyn
Page 260	Verandah
Page 262	Twickenham
Page 265	Gloucester
Page 266	Brockworth, Highgate
Page 267	Magill
Page 268	Albert, Whitmore
Page 269	Hyde, Belair
Page 270	Stirling
Page 271	Fulham, McLaren
Page 272	Lindfield
Page 273	Killara, Paddington

Page 277	Waymouth, Kingston
Page 278	Angas
Page 279	Grenfell, Keswick
Page 280	Wakefield, Flinders, Devonshire
Page 281	Halifax, Morphett Leigh, Carrington
Page 282	Angas, Richmond
Page 283	Chesser, Nelson
Page 284	Cleveland, Tusmore
Page 285	Malvern, Clifton
Page 286	Hayborough, Kensington
Page 287	Trinity
Page 288	Burnside, Norwood
Page 289	Hawthorn, Conway Aldgate
Page 290	Glenelg, Brighton
Page 291	Ascot, Flemington



# Lamps - Table

Two winged siren table lights finished in polished brass, with S1060 glass shades, shown in a South Australian private residence

There is no better way to decorate your entrance hall, living room or bedroom than with a quality Australian designed and constructed table lamp. Robert Kitto Lighting produces Australia's best table lamps merging quality, safety and refined styles. Whether it be lighting for focused work like reading, stylish mood lamps for bedside tables or tall ornate lamps to add a touch of luxury highlighting the best of your household's décor, our collection at Robert Kitto is sure to have the perfect fit for you.

From simple and functional designs, to elaborate and contemporary styles, our lamps can be an integral part of

your home with our wide range of stylistic elements for you to choose from. Our new Findon or Beverley models are perfect as reading lights in your home, incorporating either a modern, industrial style, or a more elegant lamp for your space. The Kilkenny model, designed specifically to provide a focused, bright light, features a flexible, adjustable arm to make manoeuvring simple, and is a versatile piece both practically and visually.

Browse our vast range of products here or visit a Robert Kitto stockist to experience them for yourself.



### TLC1130

Seymour bright chrome table lamp shown with an **S1130** shade.  
Bases and shades only available in sets of two.

**Wiring:** 1x B22 (BC), 100 watt maximum globe holder(s).  
With 2.1 metres of black PVC cable with inline switch and plug.

Lamp shade dimensions:  
**Width:** 400mm **Depth:** 400mm  
**Height:** 550mm **Weight:** 2.3Kg.

Table lamp base dimensions:  
**Width:** 320mm **Depth:** 320mm  
**Height:** 216mm. **Weight:** 0.7Kg

**Total Height:** 690mm.



### TLC1

Kilkenny table lamp shown in old brass with an **SMD150** old brass shade.  
Hand finished in either polished brass (-PB), old brass (-OB),  
black bronze (-BB), satin nickel (-SN), or bright chrome (-BC).

**Wiring:** 1x B22 (BC), 40 watt maximum switched globe holder(s).  
With two metre cable and plug. Approved to Australian standards.

**Width:** 143mm **Depth:** 143mm  
**Height:** 545mm **Weight:** 2.0Kg.

Christine table lamp shown in old brass with an **SP1168** shade.  
Hand finished in either polished brass (-PB), old brass (-OB),  
black bronze (-BB), antique nickel (-AN), or bright chrome (-BC).

**Wiring:** 1x B22 (BC), 60 watt maximum switched globe holder(s).  
With two metre cable and plug.  
Approved to Australian standards.

**Width:** 165mm **Depth:** 165mm  
**Height:** 600mm **Weight:** 2.9Kg.

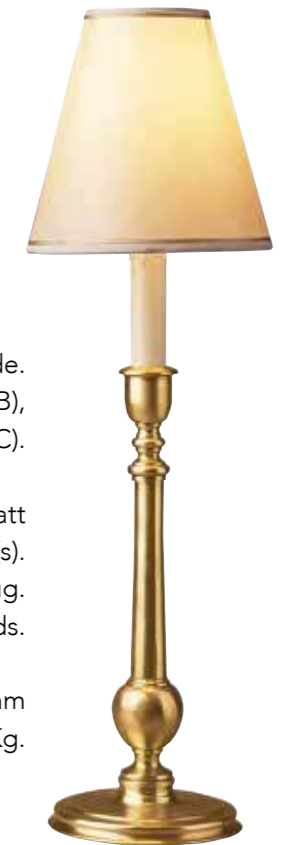

### TLC3



### TLC4

Suzanne table lamp shown in old brass with an **SP15L** shade. Hand finished in either polished brass (-PB),  
old brass (-OB), black bronze (-BB), antique nickel (-AN),  
or bright chrome (-BC).

**Wiring:** 1x B22 (BC), 60 watt maximum switched globe holder(s).  
With two metre cable and plug. Approved to Australian standards.

**Width:** 165mm **Depth:** 165mm  
**Height:** 480mm **Weight:** 1.5Kg.



**TLC5**

Isobel table lamp shown in old brass with an **S504** glass shade. Hand finished in either polished brass (-PB), old brass (-OB), black bronze (-BB), antique nickel (-AN), or bright chrome (-BC).

**Wiring:** 1x B22 (BC), 60 watt maximum switched globe holder(s). With two metre cordset and plug. Approved to Australian standards.

**Width:** 160mm **Depth:** 160mm  
**Height:** 460mm **Weight:** 2.6Kg.

**TLC6**



Bronte table lamp shown in polished brass with a **G2F** polished brass gallery and an **S501-1** glass shade. Hand finished in either polished brass (-PB), old brass (-OB), black bronze (-BB), antique nickel (-AN), or bright chrome (-BC).

**Wiring:** 1x B22 (BC), 60 watt maximum globe holder(s). With two metre switched cordset and plug. Approved to Australian standards.

**Width:** 120mm **Depth:** 120mm **Height:** 530mm **Weight:** 2.3Kg.



**TLC7**

Chatswood table lamp shown in antique nickel with an **S3004** glass shade. Hand finished in either polished brass (-PB), old brass (-OB), black bronze (-BB), antique nickel (-AN), or bright chrome (-BC).

**Wiring:** 1x B22 (BC), 60 watt maximum globe holder(s). With two metre switched cordset and plug. Approved to Australian standards.

**Width:** 120mm **Depth:** 120mm **Height:** 310mm **Weight:** 1.5Kg.

**TLC8**



Randwick table lamp shown in antique nickel with an **S1509** glass shade. Hand finished in either polished brass (-PB), old brass (-OB), black bronze (-BB), antique nickel (-AN), or bright chrome (-BC).

**Wiring:** 1x B22 (BC), 60 watt maximum globe holder(s). With two metre switched cordset and plug. Approved to Australian standards.

**Width:** 120mm **Depth:** 120mm **Height:** 310mm **Weight:** 1.5Kg.



**TLC9**

Bellevue table lamp shown in polished brass. Hand finished in either polished brass (-PB), old brass (-OB), black bronze (-BB), antique nickel (-AN), or bright chrome (-BC).

**Wiring:** 1x B22 (BC), 60 watt maximum switched globe holder(s). With two metre cable and plug. Approved to Australian standards.

**Width:** 130mm **Depth:** 130mm  
**Height:** 420mm **Weight:** 1.2Kg.

**TLC10**

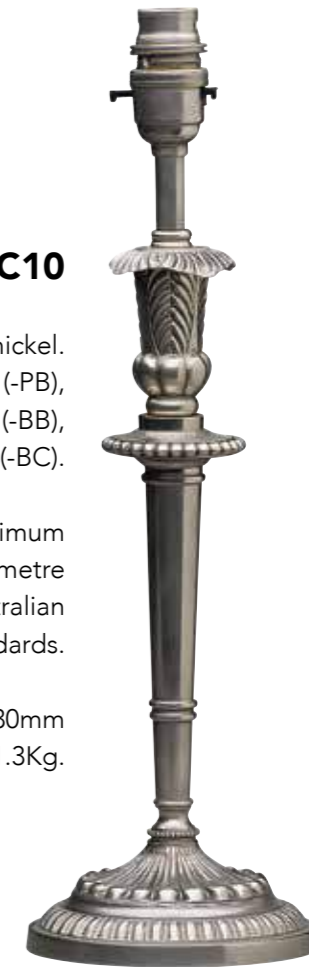

Watson table lamp shown in antique nickel. Hand finished in either polished brass (-PB), old brass (-OB), black bronze (-BB), antique nickel (-AN), or bright chrome (-BC).

**Wiring:** 1x B22 (BC), 60 watt maximum switched globe holder(s). With two metre cable and plug. Approved to Australian standards.

**Width:** 130mm **Depth:** 130mm  
**Height:** 390mm **Weight:** 1.3Kg.

**TLC11**



Waverley table lamp shown in antique nickel. Hand finished in either polished brass (-PB), old brass (-OB), black bronze (-BB), antique nickel (-AN), or bright chrome (-BC).

**Wiring:** 1x B22 (BC), 60 watt maximum switched globe holder(s). With two metre cable and plug. Approved to Australian standards.

**Width:** 130mm **Depth:** 130mm **Height:** 420mm **Weight:** 1.1Kg.

## TLC12

Cremorne table lamp shown in antique bronze. Hand finished in either polished brass (-PB), old brass (-OB), black bronze (-BB), antique bronze (-AB), antique nickel (-AN), bright chrome (-BC) or powder coated (-PC).

**Wiring:** 1x B22 (BC), 60 watt maximum switched globe holder(s). With two metre cable and plug. Approved to Australian standards.

**Width:** 120mm **Depth:** 120mm  
**Height:** 340mm **Weight:** 1.8Kg.



## TLC13

Lonsdale table lamp shown in old brass. Hand finished in either polished brass (-PB), old brass (-OB), black bronze (-BB), antique nickel (-AN), or bright chrome (-BC).

**Wiring:** 1x B22 (BC), 60 watt maximum switched globe holder(s). With two metre cable and plug. Approved to Australian standards.

**Width:** 120mm **Depth:** 120mm  
**Height:** 390mm **Weight:** 1.9Kg.

## TLC14

Dulwich table lamp shown in old brass. Hand finished in either polished brass (-PB), old brass (-OB), black bronze (-BB), antique nickel (-AN), or bright chrome (-BC).

**Wiring:** 1x B22 (BC), 60 watt maximum switched globe holder(s). With two metre cable and plug. Approved to Australian standards.

**Width:** 120mm **Depth:** 120mm **Height:** 410mm **Weight:** 2.6Kg.



## TLC15

Cheltenham table lamp shown in old brass. Hand finished in either polished brass (-PB), old brass (-OB), black bronze (-BB), antique nickel (-AN), or bright chrome (-BC).

**Wiring:** 1x B22 (BC), 60 watt maximum switched globe holder(s). With two metre cable and plug. Approved to Australian standards.

**Width:** 135mm **Depth:** 135mm **Height:** 550mm **Weight:** 1.9Kg.





### TLC16

Brompton table lamp shown in old brass. Hand finished in either polished brass (-PB), old brass (-OB), black bronze (-BB), antique nickel (-AN), or bright chrome (-BC).

**Wiring:** 1x B22 (BC), 60 watt maximum switched globe holder(s). With two metre cable and plug. Approved to Australian standards.

**Width:** 145mm **Depth:** 145mm **Height:** 370mm **Weight:** 1.6Kg.



### TLC17

Elliot table lamp shown in old brass with a **T.SH706-CR** fabric shade. Hand finished in either polished brass (-PB), old brass (-OB), black bronze (-BB), antique bronze (-AB), antique nickel (-AN), or bright chrome (-BC).

**Wiring:** 1x B22 (BC), 60 watt maximum switched globe holder(s). With two metre cable and plug. Approved to Australian standards.

**Width:** 165mm **Depth:** 165mm  
**Height:** 520mm **Weight:** 1.8Kg.

### TLC18

Clayton table lamp shown in antique nickel. Hand finished in either polished brass (-PB), old brass (-OB), black bronze (-BB), antique nickel (-AN), or bright chrome (-BC).

**Wiring:** 1x B22 (BC), 60 watt maximum switched globe holder(s). With two metre cable and plug. Approved to Australian standards.

**Width:** 90mm **Depth:** 90mm  
**Height:** 410mm **Weight:** 0.6Kg.



### TLC19

Lucinda table lamp shown in polished brass. Hand finished in either polished brass (-PB), old brass (-OB), black bronze (-BB), antique nickel (-AN), or bright chrome (-BC).

**Wiring:** 1x B22 (BC), 60 watt maximum switched globe holder(s). With two metre cable and plug. Approved to Australian standards.

**Width:** 110mm **Depth:** 110mm  
**Height:** 410mm **Weight:** 0.6Kg.



### TLC20

Loxton table lamp shown in antique bronze. Hand finished in either polished brass (-PB), old brass (-OB), black bronze (-BB), antique bronze (-AB), antique nickel (-AN), or bright chrome (-BC).

**Wiring:** 1x B22 (BC), 60 watt maximum switched globe holder(s). With two metre cable and plug. Approved to Australian standards

**Width:** 130mm **Depth:** 130mm  
**Height:** 430mm **Weight:** 1.5Kg.





### TLC21

Ashbourne table lamp shown in polished brass. With an **S163** glass shade. Hand finished in either polished brass (-PB), old brass (-OB), black bronze (-BB), antique nickel (-AN), or bright chrome (-BC).

**Wiring:** 1x B22 (BC), 60 watt maximum switched globe holder(s). With two metre cable and plug. Approved to Australian standards.

**Width:** 120mm **Depth:** 120mm  
**Height:** 430mm **Weight:** 2.2Kg.



### TLC22

Lyndhurst table lamp shown in old brass with an **S1020-OG** glass shade. Hand finished in either polished brass (-PB), old brass (-OB), black bronze (-BB), antique nickel (-AN), or bright chrome (-BC).

**Wiring:** 1x B22 (BC), 60 watt maximum switched globe holder(s). With two metre cable and plug. Approved to Australian standards.

**Width:** 165mm **Depth:** 165mm  
**Height:** 550mm **Weight:** 1.9Kg.



### TLC23

Lindfield table lamp shown in old brass with a **G2F** old brass gallery and an **S8044-6** glass shade. Hand finished in either polished brass (-PB), old brass (-OB), black bronze (-BB), antique nickel (-AN), or bright chrome (-BC).

**Wiring:** 1x B22 (BC), 60 watt maximum switched globe holder(s). With two metre cable and plug. Approved to Australian standards.

**Width:** 120mm **Depth:** 120mm  
**Height:** 340mm **Weight:** 1.6Kg.

### TLC24

Killara table lamp shown in old brass. Hand finished in either polished brass (-PB), old brass (-OB), black bronze (-BB), antique nickel (-AN), or bright chrome (-BC).

**Wiring:** 1x B22 (BC), 60 watt maximum switched globe holder(s). With two metre cable and plug. Approved to Australian standards.

**Width:** 120mm **Depth:** 120mm  
**Height:** 340mm **Weight:** 1.6Kg.

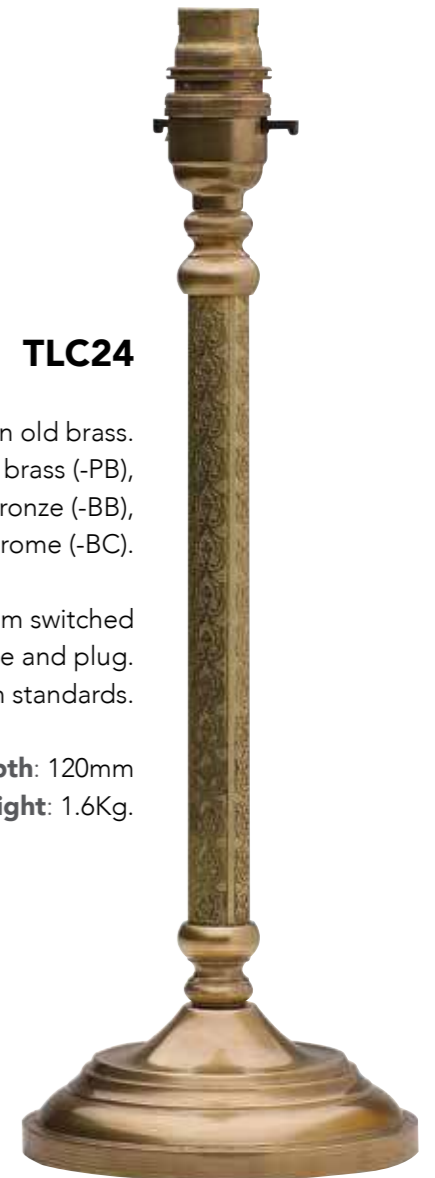

### TLC25

Findon table lamp shown in antique nickel with an **SMD150** antique nickel shade. Hand finished in either polished brass (-PB), old brass (-OB), black bronze (-BB), antique nickel (-AN), or bright chrome (-BC).

**Wiring:** 1x B22 (BC), 60 watt maximum globe holder(s). With two metre switched cordset and plug. Approved to Australian standards.

**Width:** 143mm **Depth:** 143mm  
**Height:** 545mm **Weight:** 3.3Kg.



### TLC26

Beverley table lamp shown in polished brass with an **S310** glass shade. Hand finished in either polished brass (-PB), old brass (-OB), black bronze (-BB), antique nickel (-AN), or bright chrome (-BC).

**Wiring:** 1x B22 (BC), 60 watt maximum globe holder(s). With two metre switched cordset and plug. Approved to Australian standards.

**Width:** 143mm **Depth:** 143mm  
**Height:** 545mm **Weight:** 3.3Kg.

### TLC28

Henley table lamp shown in antique nickel with an **S944** faux leather shade. Hand finished in either polished brass (-PB), old brass (-OB), black bronze (-BB), antique nickel (-AN), or bright chrome (-BC).

**Wiring:** 1x B22 (BC), 60 watt maximum switched globe holder(s). With two metre cable and plug. Approved to Australian standards.

**Width:** 165mm **Depth:** 165mm **Height:** 340mm **Weight:** 1.3Kg.



### TLC29

Kidman table lamp shown in old brass. Hand finished in either polished brass (-PB), old brass (-OB), black bronze (-BB), antique nickel (-AN), or bright chrome (-BC).

**Wiring:** 1x B22 (BC), 60 watt maximum switched globe holder(s). With two metre cable and plug. Approved to Australian standards.

**Width:** 165mm **Depth:** 165mm  
**Height:** 340mm **Weight:** 1.4Kg.

### TLC30

Gilberton table lamp shown in antique nickel. Hand finished in either polished brass (-PB), old brass (-OB), black bronze (-BB), antique nickel (-AN), or bright chrome (-BC).

**Wiring:** 1x B22 (BC), 60 watt maximum switched globe holder(s). With two metre cable and plug. Approved to Australian standards.

**Width:** 165mm **Depth:** 165mm  
**Height:** 570mm **Weight:** 2.6Kg.



**TLC31**

Thorngate table lamp shown in old brass. Hand finished in either polished brass (-PB), old brass (-OB), black bronze (-BB), antique nickel (-AN), or bright chrome (-BC).

**Wiring:** 1x B22 (BC), 60 watt maximum switched globe holder(s). With two metre cable and plug. Approved to Australian standards.

**Width:** 165mm **Depth:** 165mm **Height:** 480mm **Weight:** 2.5Kg.



### TLC32

Camden table lamp shown in old brass. Hand finished in either polished brass (-PB), old brass (-OB), black bronze (-BB), antique nickel (-AN), or bright chrome (-BC).

**Wiring:** 1x B22 (BC), 60 watt maximum switched globe holder(s). With two metre cable and plug. Approved to Australian standards.

**Width:** 112mm **Depth:** 112mm  
**Height:** 450mm **Weight:** 1.9Kg.



### TLC33

Hamish table lamp shown in polished brass with an **SP1158** shade. Hand finished in either polished brass (-PB), old brass (-OB), black bronze (-BB), antique nickel (-AN), or bright chrome (-BC).

**Wiring:** 1x B22 (BC), 60 watt maximum switched globe holder(s). With two metre cable and plug. Approved to Australian standards.

**Width:** 140mm **Depth:** 140mm  
**Height:** 320mm **Weight:** 3.0Kg.



### TLC34

Henry table lamp shown in antique nickel with an **S601** glass shade. Hand finished in either polished brass (-PB), old brass (-OB), black bronze (-BB), antique nickel (-AN), or bright chrome (-BC).

**Wiring:** 1x B22 (BC), 60 watt maximum switched globe holder(s). With two metre switched cordset and plug. Approved to Australian standards.

**Width:** 140mm **Depth:** 140mm  
**Height:** 320mm **Weight:** 3.0Kg.



### TLC35

Harold table lamp shown in black bronze with a **CG130** black bronze cast gimbal and an **S4747** glass shade. Hand finished in either polished brass (-PB), old brass (-OB), black bronze (-BB), antique nickel (-AN), or bright chrome (-BC).

**Wiring:** 1x B22 (BC), 60 watt maximum switched globe holder(s). With two metre cable and plug. Approved to Australian standards.

**Width:** 140mm **Depth:** 140mm  
**Height:** 350mm **Weight:** 3.0Kg.





**TLC36**

Stewart table lamp shown in antique nickel with a **G2** antique nickel gallery and an **S3133** glass shade (left), and in antique nickel with a **G4** antique nickel gallery and an **S54** glass shade (right). Hand finished in either polished brass (-PB), old brass (-OB), black bronze (-BB), antique nickel (-AN), or bright chrome (-BC).

**Wiring:** 1x B22 (BC), 60 watt maximum switched globe holder(s). With two metre cable and plug. Approved to Australian standards.

**Width:** 140mm **Depth:** 140mm  
**Height:** 330mm **Weight:** 2.0Kg.



**TLC37**

Harvey table lamp shown in polished brass with an **ABG130** polished brass gimbal and a **SGC12-OG** glass shade. Hand finished in either polished brass (-PB), old brass (-OB), black bronze (-BB), antique nickel (-AN), or bright chrome (-BC).

**Wiring:** 1x B22 (BC), 60 watt maximum switched globe holder(s). With two metre cable and plug. Approved to Australian standards.

**Width:** 140mm **Depth:** 140mm  
**Height:** 330mm **Weight:** 2.0Kg.



**TLC38**

John table lamp shown in black bronze with a **G2** black bronze gallery and an **S901** glass shade. Hand finished in either polished brass (-PB), old brass (-OB), black bronze (-BB), antique nickel (-AN), or bright chrome (-BC).

**Wiring:** 1x B22 (BC), 60 watt maximum switched globe holder(s). With two metre cable and plug. Approved to Australian standards.

**Width:** 140mm **Depth:** 140mm  
**Height:** 330mm **Weight:** 2.2Kg.



**TLC40**

Maxwell table lamp shown in old brass with an **SP61116** parchment shade. Hand finished in either polished brass (-PB), old brass (-OB), black bronze (-BB), antique nickel (-AN), or bright chrome (-BC).

**Wiring:** 1x B22 (BC), 60 watt maximum switched globe holder(s). With two metre cable and plug. Approved to Australian standards.

**Width:** 300mm **Depth:** 140mm  
**Height:** 415mm **Weight:** 2.5Kg.



**TLC39**

Norman table lamp shown in polished brass with an **SF8-3** polished brass spider and an **S4528-MO** glass shade. Hand finished in either polished brass (-PB), old brass (-OB), black bronze (-BB), antique nickel (-AN), or bright chrome (-BC).

**Wiring:** 1x B22 (BC), 60 watt maximum switched globe holder(s). With two metre cable and plug. Approved to Australian standards.

**Width:** 140mm **Depth:** 140mm  
**Height:** 330mm **Weight:** 2.0Kg.

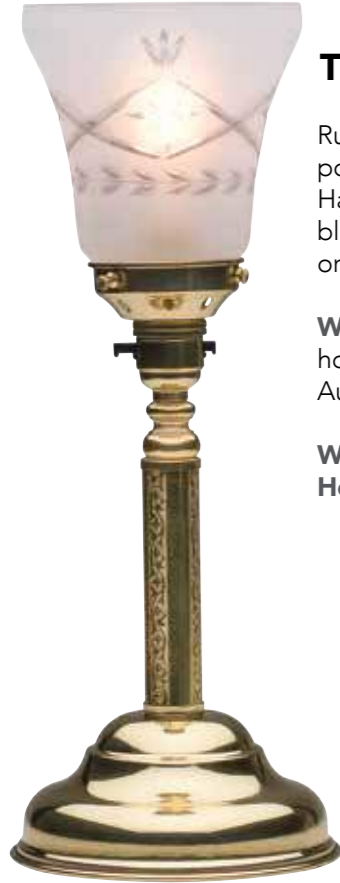

### TLC41

Russell table lamp shown in polished brass with a **G2** polished brass gallery and an **S501-4** glass shade. Hand finished in either polished brass (-PB), old brass (-OB), black bronze (-BB), antique nickel (-AN), or bright chrome (-BC).

**Wiring:** 1x B22 (BC), 60 watt maximum switched globe holder(s). With two metre cable and plug. Approved to Australian standards.

**Width:** 140mm **Depth:** 140mm  
**Height:** 230mm **Weight:** 1.9Kg.



### TLC42

James table lamp shown in black bronze with a **G2** black bronze gallery and an **S901** glass shade. Hand finished in either polished brass (-PB), old brass (-OB), black bronze (-BB), antique nickel (-AN), or bright chrome (-BC).

**Wiring:** 1x B22 (BC), 60 watt maximum switched globe holder(s). With two metre cable and plug. Approved to Australian standards.

**Width:** 140mm **Depth:** 140mm  
**Height:** 230mm **Weight:** 1.9Kg.



### TLC45

Annabel table lamp shown in antique nickel with a **G2F** antique nickel gallery and an **S501-1** glass shade. Hand finished in either polished brass (-PB), old brass (-OB), black bronze (-BB), antique nickel (-AN), or bright chrome (-BC).

**Wiring:** 1x B22 (BC), 60 watt maximum switched globe holder(s). With two metre cable and plug. Approved to Australian standards.

**Width:** 140mm **Depth:** 140mm **Height:** 415mm. **Weight:** 2.0Kg.



### TLC43

George table lamp shown in polished brass with a **G2** polished brass gallery and an **S2170** glass shade. Hand finished in either polished brass (-PB), old brass (-OB), black bronze (-BB), antique nickel (-AN), or bright chrome (-BC).

**Wiring:** 1x B22 (BC), 60 watt maximum switched globe holder(s). With two metre cable and plug. Approved to Australian standards.

**Width:** 140mm **Depth:** 140mm  
**Height:** 230mm. **Weight:** 1.9Kg.



### TLC44

Philip table lamp shown in polished brass with a **G4** polished brass gallery and an **S94030** glass shade. Hand finished in either polished brass (-PB), old brass (-OB), black bronze (-BB), antique nickel (-AN), or bright chrome (-BC).

**Wiring:** 1x B22 (BC), 60 watt maximum switched globe holder(s). With two metre cable and plug. Approved to Australian standards.

**Width:** 140mm **Depth:** 140mm  
**Height:** 230mm. **Weight:** 2.2Kg.



Shown in polished brass with a **G2F** polished brass gallery and an **S92720** glass shade



Shown in polished brass with a **G2F** polished brass gallery and an **S96930** glass shade



Shown in polished brass with an **S1702** glass shade



Shown in black bronze with a **G2** black bronze gallery and an **S404** glass shade

### TLC46

Victoria table lamp. Hand finished in either polished brass (-PB), old brass (-OB), black bronze (-BB), antique nickel (-AN), or bright chrome (-BC).

**Wiring:** 1x B22 (BC), 60 watt maximum switched globe holder(s). With two metre cable and plug. Approved to Australian standards.

**Width:** 140mm **Depth:** 140mm  
**Height:** 370mm. **Weight:** 1.4Kg.



**TL1**

Monroe table lamp. Spun steel finished in satin nickel, with timber column.

**Wiring:** 1x B22 (BC), 60 watt maximum switched globe holder(s). With two metre cable and plug. Approved to Australian standards.

**Width:** 140mm **Depth:** 140mm **Height:** 420mm. **Weight:** 1.0Kg.



**TL3**

Samuel table lamp. Spun steel base and cigar shaped column finished in satin nickel.

**Wiring:** 1x B22 (BC), 60 watt maximum switched globe holder(s). With two metre cable and plug. Approved to Australian standards.

**Width:** 140mm **Depth:** 140mm **Height:** 350mm. **Weight:** 1.0Kg.



**TL2**

Lyndon table lamp. Spun steel finished in satin nickel, with timber column.

**Wiring:** 1x B22 (BC), 60 watt maximum switched globe holder(s). With two metre cable and plug. Approved to Australian standards.

**Width:** 140mm **Depth:** 140mm **Height:** 420mm **Weight:** 1.1Kg.

**TL4**

Denna table lamp. Spun steel finished in satin nickel.

**Wiring:** 1x B22 (BC), 60 watt maximum switched globe holder(s). With two metre cable and plug. Approved to Australian standards.

**Width:** 140mm **Depth:** 140mm **Height:** 420mm **Weight:** 1.1Kg.



**TL5**

Timothy table lamp. Spun steel finished in satin nickel.

**Wiring:** 1x B22 (BC), 60 watt maximum switched globe holder(s). With two metre cable and plug. Approved to Australian standards.

**Width:** 140mm **Depth:** 140mm **Height:** 420mm. **Weight:** 0.9Kg.

**TL540CND**

Nova table lamp. Oak wood base and column with tall candle.

**Wiring:** 1x B22 (BC), 60 watt maximum switched globe holder(s). With two metre cable and plug. Approved to Australian standards.

**Width:** 130mm **Depth:** 130mm **Height:** 540mm. **Weight:** 1.0Kg.



**TL610CND**

Nelson table lamp. Oak wood base and column.

**Wiring:** 1x B22 (BC), 60 watt maximum switched globe holder(s). With two metre cable and plug. Approved to Australian standards.

**Width:** 130mm **Depth:** 130mm **Height:** 610mm. **Weight:** 1.9Kg.



**TL515BAM**

Winslow (short) table lamp. Oak bamboo base and column with tall candle.

**Wiring:** 1x B22 (BC), 60 watt maximum switched globe holder(s). With two metre cable and plug. Approved to Australian standards.

**Width:** 130mm **Depth:** 130mm **Height:** 515mm. **Weight:** 1.0Kg.

**TL700BAM**

Winslow (tall) table lamp. Oak bamboo base and column with tall candle.

**Wiring:** 1x B22 (BC), 60 watt maximum switched globe holder(s). With two metre cable and plug. Approved to Australian standards.

**Width:** 130mm **Depth:** 130mm **Height:** 700mm. **Weight:** 1.2Kg.



# Lamps - Floor

Utilising your floor for lighting in the house is a great way to make the most of your floor space, whilst also adding visual interest. Floor lamps are often neglected when planning lighting, but there is no denying that the look and ambience provided by floor lights are second to none. Take a look at our special catalogue of floor lamps that provide great illumination and add class and style to your rooms.

At Robert Kitto, we are aware of the importance of design, and each of our floor lights are designed to satisfy modern and emerging trends, as well as traditional styles to suit all ranges of décor.

For more simplistic or minimalist design, our Owen and Eton floor lamps are a perfect addition in this style. These renowned, time-tested designs work well in any setting, and are available with your choice of our range of hand metal finishes including aged nickel, antique bronze, polished brass, old brass and bright chrome. While the Eton lamp is extremely simple in design, the Owen has just a touch of decorativeness that can create an elegant, understated impact in your room. The sharp angles and edges of the Hamilton model make it truly versatile, and the opaque shade delivers a soft and subtle illumination. For those looking for more modern or contemporary styles, we have our special Cheltenham and Ferguson floor lamp models, both designed to fit perfectly in modern households. These lamps do away with curves and angles featuring straight, slender mounts with the light source fitted on top.

For a mix of traditional and modern styles, our Osmond floor lamp, which features an ornamentally designed cover for the light fixture is a perfect addition.

With our quality range of designs, it suffices to say that for high quality floor lights, Robert Kitto is the right place to look.



FSFSA floor standard fluted swing arm, Hamilton finished in Old Brass with a SP61116 parchment shade, shown in a South Australian Private Residence.



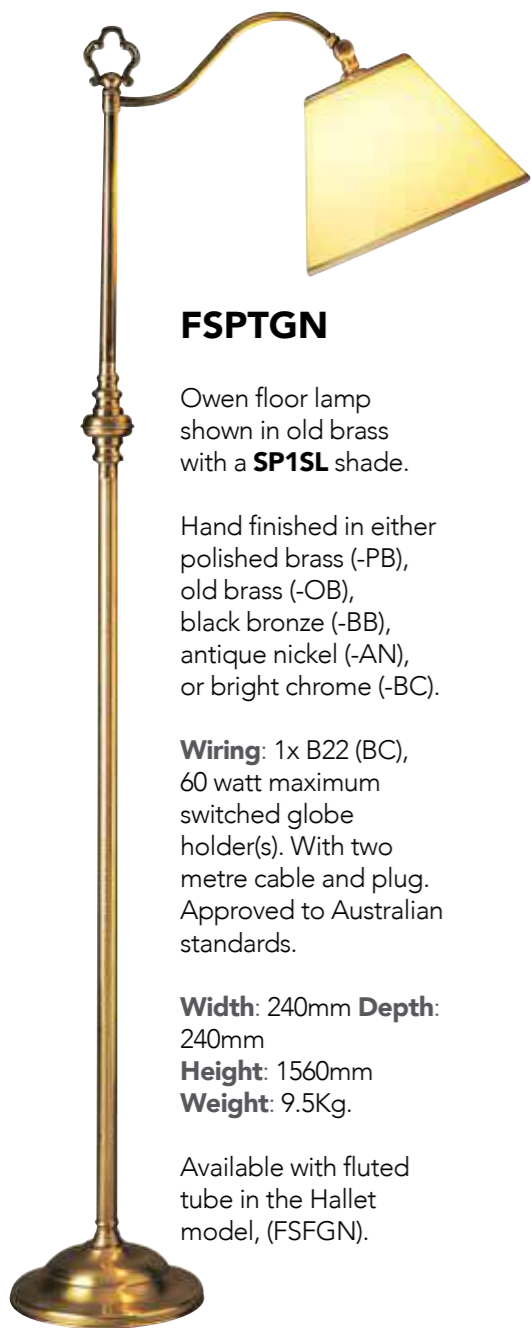

### FSPTGN

Owen floor lamp shown in old brass with a **SP1SL** shade.

Hand finished in either polished brass (-PB), old brass (-OB), black bronze (-BB), antique nickel (-AN), or bright chrome (-BC).

**Wiring:** 1x B22 (BC), 60 watt maximum switched globe holder(s). With two metre cable and plug. Approved to Australian standards.

**Width:** 240mm **Depth:** 240mm  
**Height:** 1560mm  
**Weight:** 9.5Kg.

Available with fluted tube in the Hallet model, (FSFGN).



### FS2

Eton floor lamp shown in old brass. Hand finished in either polished brass (-PB), old brass (-OB), black bronze (-BB), antique nickel (-AN), or bright chrome (-BC).

**Wiring:** 1x B22 (BC), 60 watt maximum switched globe holder(s). With two metre cable and plug. Approved to Australian standards.

**Width:** 240mm **Depth:** 240mm  
**Height:** 1500mm + flexible arm **Weight:** 9.1Kg.



### FSFSA

Hamilton floor lamp shown in black bronze with a **SP61116** shade.

Hand finished in either polished brass (-PB), old brass (-OB), black bronze (-BB), antique nickel (-AN), or bright chrome (-BC).

**Wiring:** 1x B22 (BC), 60 watt maximum switched globe holder(s). With two metre cable and plug. Approved to Australian standards.

**Width:** 240mm **Depth:** 240mm  
**Height:** 1420mm **Weight:** 9.8Kg.

-AN & -BC finishes have a white candle cover not cream.

Available with patterned tube in the Oxley model, (FSPTSA).

### FSPT

Osmond floor lamp shown in antique nickel

Hand finished in either polished brass (-PB), old brass (-OB), black bronze (-BB), antique nickel (-AN), or bright chrome (-BC).

**Wiring:** 1x B22 (BC), 60 watt maximum switched globe holder(s). With two metre cable and plug. Approved to Australian standards.

**Width:** 240mm  
**Depth:** 240mm  
**Height:** 1500mm  
**Weight:** 9.5Kg.

Available with fluted tube in the Austin model, (FSF).

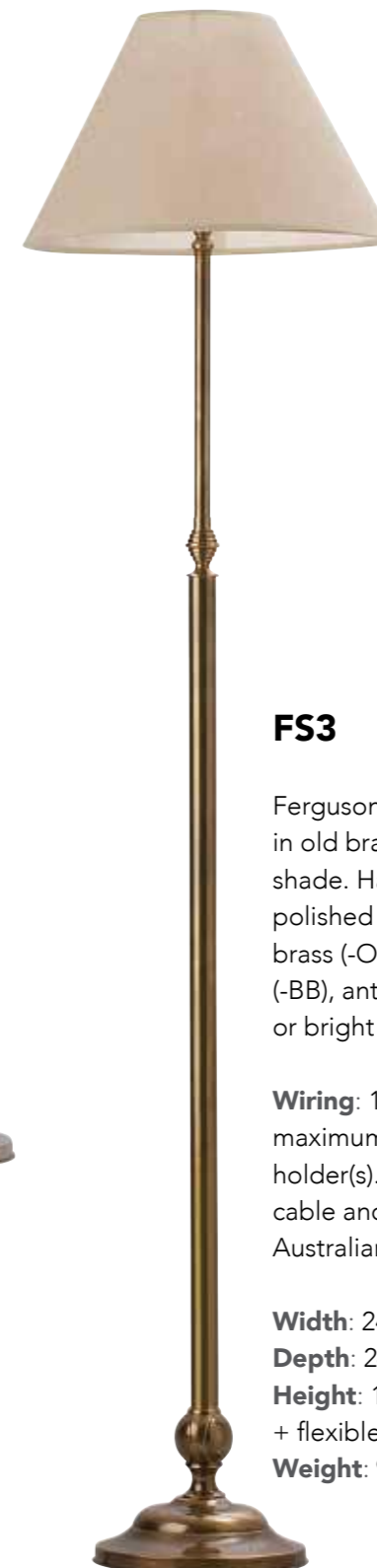

### FS3

Ferguson floor lamp shown in old brass with an **SP61116** shade. Hand finished in either polished brass (-PB), old brass (-OB), black bronze (-BB), antique nickel (-AN), or bright chrome (-BC).

**Wiring:** 1x B22 (BC), 60 watt maximum switched globe holder(s). With two metre cable and plug. Approved to Australian standards.

**Width:** 240mm  
**Depth:** 240mm  
**Height:** 1500mm + flexible arm  
**Weight:** 9.1Kg.

### FS4

Cheltenham floor lamp shown in polished brass.

Hand finished in either polished brass (-PB), old brass (-OB), black bronze (-BB), antique nickel (-AN), or bright chrome (-BC).

**Wiring:** 1x B22 (BC), 60 watt maximum switched globe holder(s). With two metre cable and plug. Approved to Australian standards.

**Width:** 240mm  
**Depth:** 240mm  
**Height:** 1500mm  
**Weight:** 9.5Kg.

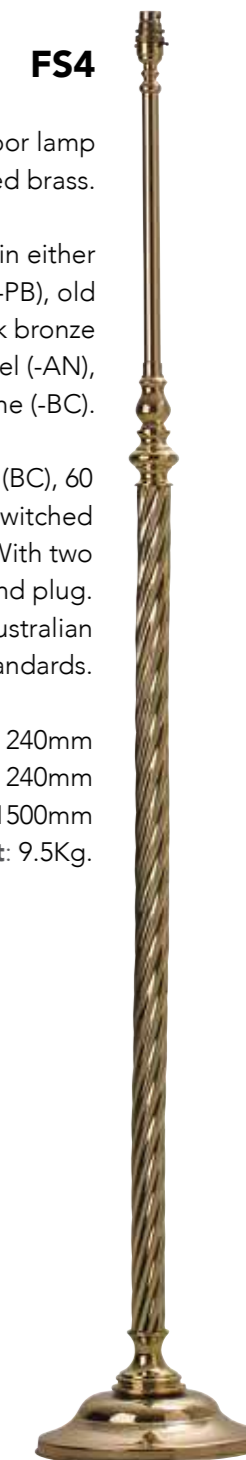

# Wall - Lanterns

Using wall lanterns is a great way to provide decorative lighting to a setting that needs it. For different parts of your exteriors, using a wall lantern doesn't just highlight and accent the walls of the building but it enlightens and improves the facades of the property. Wall lanterns carry a certain charisma and they possess old world charm, yet also enhance security and safety at night time. Lanterns bring the old-world charm and poise that has been associated with them for centuries and with the help of modern technology, wall lanterns can really be creatively used to enhance your exteriors or undercover outdoor areas. At Robert Kitto, we have a collection of delicately designed wall lanterns that will suit the tastes of even the most discerning users. Our products are constructed with long, durable use in mind, and we always use the best quality of materials available.

Our wall lanterns bring beautiful designs and comfortable, relaxed mood lighting to the table. For simplicity, take a look at our black wall lantern models. Made with reinforced metal and sporting a classy matte black finish, these lanterns can be effectively used both inside your house and outside. While the WL2011 design sports the classic box look, the WL2003 and WL-F10 designs are tapered, giving them a regal flavor. The WL102 has been a favourite of our users for years, sporting a classic design and an antique silver finish. The WL105 has a slight taper and crowning at the top, and you can choose between antique brass, bronze or nickel finishes for just the kind of look you want. The WL108 and WL2000 are perfect if you want a lantern for a retro-themed room, and the antique metal finishes will elevate and brighten surroundings. At Robert Kitto, we have a wide range of products to suit your wall lantern needs.

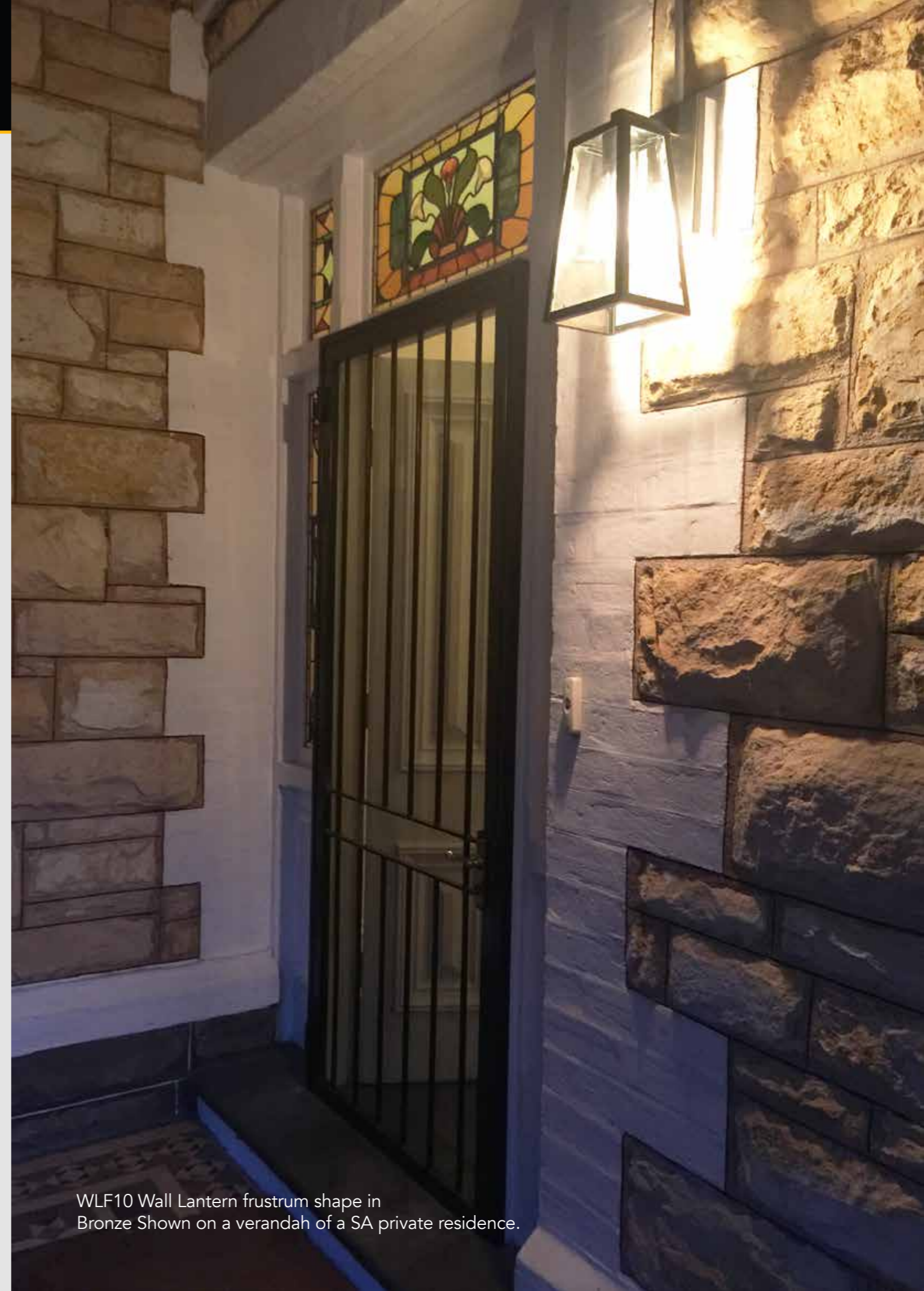

WLF10 Wall Lantern frustrum shape in Bronze Shown on a verandah of a SA private residence.

### WL-F10-BZ

Black bronze frustum wall lantern with bevelled tapered glass panels, shown with VIN-ST64-60-ES (globe, separate item).

**Wiring:** 1x E27 (ES), 60 watt maximum globe holder(s).

Mounting plate dimensions:

**Width:** 105mm **Depth:** 15mm **Height:** 200mm

Total Dimensions:

**Width:** 185mm **Depth:** 170mm

**Height:** 335mm **Weight:** 1.3Kg.

(Not tested for IP rating).



### WL-F10-SN

Satin nickel frustum wall lantern with bevelled tapered glass panels, shown with VIN-ST64-60-ES (globe, separate item).

**Wiring:** 1x E27 (ES), 60 watt maximum globe holder(s).

Mounting plate dimensions:

**Width:** 105mm **Depth:** 15mm **Height:** 200mm

Total Dimensions:

**Width:** 185mm **Depth:** 170mm

**Height:** 335mm **Weight:** 1.3Kg.

(Not tested for IP rating).



### WL2003

Matt black wall lantern with two side panes and a front pane of plain clear glass in a traditional styled hinged door for globe access.

**Wiring:** 1x E14 (SES), 60 watt maximum globe holder(s).

**Width:** 260mm

**Depth:** 275mm

**Height:** 550mm

**Weight:** 5.5Kg.

(Not tested for IP rating).



**WL2000-AS**

**WL2000**

Wall lantern with two side and one front toughened plain clear glass panes in a traditional styled hinged door for globe access. Available in either matt black (-MB), antique brass (-AB), or antique silver (-AS).

**Wiring:** 1x E14 (SES), 60 watt maximum globe holder(s). (Meets IP44 standards).

**Width:** 288mm **Depth:** 175mm  
**Height:** 450mm **Weight:** 4.5Kg.



**WL2000-MB**



**WL102-MB**

**WL102**

Wall lantern with two side and one front toughened plain clear glass panes in a traditional styled hinged door for globe access. Available, and shown, in either matt black (-MB), antique brass (-AB), or antique silver (-AS).

**Wiring:** 2x E14 (SES), 60 watt maximum globe holder(s). (Meets IP44 standards).

**Width:** 330mm **Depth:** 230mm **Height:** 530mm **Weight:** 6.3Kg.



**WL102-AS**



**WL102-AB**

### WL105-AB

Antique brass wall lantern with two side and one front toughened plain clear glass panes in a traditional styled hinged door for globe access, shown with **VIN-LED-C35T-E14** (globe, separate item).

**Wiring:** 1x E14 (SES), 60 watt maximum globe holder(s).

**Width:** 140mm **Depth:** 170mm  
**Height:** 355mm **Weight:** 2.1Kg  
(Meets IP13 standards).



### WL2011-AB

Antique brass wall lantern with two side and one front toughened plain clear glass panes in a traditional styled hinged door for globe access, shown with **VIN-LED-C35T-E14** (globe, separate item).

**Wiring:** 1x E14 (SES), 60 watt maximum globe holder(s).

**Width:** 200mm **Depth:** 110mm  
**Height:** 355mm **Weight:** 2.2Kg  
(Meets IP35 standards).



### WL105-AS

Antique silver wall lantern with two side and one front toughened plain clear glass panes in a traditional styled hinged door for globe access, shown with **VIN-LED-C35T-E14** (globe, separate item).

**Wiring:** 1x E14 (SES), 60 watt maximum globe holder(s).

**Width:** 140mm **Depth:** 170mm  
**Height:** 355mm **Weight:** 2.1Kg  
(Meets IP13 standards).



### WL2011-AS

Antique silver wall lantern with two side and one front toughened plain clear glass panes in a traditional styled hinged door for globe access, shown with **VIN-LED-C35T-E14** (globe, separate item).

**Wiring:** 1x E14 (SES), 60 watt maximum globe holder(s).

**Width:** 200mm **Depth:** 110mm  
**Height:** 355mm **Weight:** 2.2Kg  
(Meets IP35 standards).

### WL105-MB

Matt black wall lantern with two side and one front toughened plain clear glass panes in a traditional styled hinged door for globe access, shown with **VIN-LED-C35T-E14** (globe, separate item).

**Wiring:** 1x E14 (SES), 60 watt maximum globe holder(s).

**Width:** 140mm **Depth:** 170mm  
**Height:** 355mm **Weight:** 2.1Kg  
(Meets IP13 standards).



### WL2011-MB

Matt black wall lantern with two side and one front toughened plain clear glass panes in a traditional styled hinged door for globe access, shown with **VIN-LED-C35T-E14** (globe, separate item).

**Wiring:** 1x E14 (SES), 60 watt maximum globe holder(s).

**Width:** 200mm **Depth:** 110mm  
**Height:** 355mm **Weight:** 2.2Kg  
(Meets IP35 standards).



WB36 - Sign Light  
shown in Matt Black with SC10 shade.

IP13 rated  
(included two piece 100mm backplate)

Wiring: 1x B22 60 watt  
maximum globeholder(s)

Projection 320mm

*Photographed at St. Louis House of Fine Ice Cream & Dessert, Adelaide*



### WBU6-G3DS-E

Carrington exterior wall bracket with an integrated **G3DS** gallery, shown in powder coated matt black with an **SPH150-OG** glass shade. Meets IP44 standards. Hand finished in either polished brass (-PB), old brass (-OB), black bronze (-BB), antique bronze (-AB), antique nickel (-AN), bright chrome (-BC), or powder coated (-PC).

**Wiring:** 1x B22 (BC), 60 watt maximum globe holder(s).  
**Width:** 100mm **Depth:** 210mm **Height:** 140mm



### WBU6-G3DS-E

Carrington exterior wall bracket with an integrated **G3DS** gallery, shown in powder coated matt black with an **S211** glass shade. Meets IP44 standards. Hand finished in either polished brass (-PB), old brass (-OB), black bronze (-BB), antique bronze (-AB), antique nickel (-AN), bright chrome (-BC), or powder coated (-PC).

**Wiring:** 1x B22 (BC), 60 watt maximum globe holder(s).  
**Width:** 100mm **Depth:** 210mm **Height:** 140mm

### WBU348-G4DS-E

Chesser exterior wall bracket with an integrated **G4DS** gallery, shown in powder coated matt black with an **SPH200-OM** glass shade. Meets IP44 standards. Hand finished in either polished brass (-PB), old brass (-OB), black bronze (-BB), antique bronze (-AB), antique nickel (-AN), bright chrome (-BC), or powder coated (-PC).

**Wiring:** 1x B22 (BC), 60 watt maximum globe holder(s).  
**Width:** 108mm **Depth:** 270mm **Height:** 190mm



### WB200-BGS-E

Medford Cast aluminium wall bracket powder coated in satin black. Includes blown glass small with ring and finial.

**Wiring:** 1x B22 (BC), 60 watt maximum globe holder(s).  
Meets IP44 standards.

**Width:** 140mm **Depth:** 185mm **Height:** 350mm

Also available in larger size with medium blown glass, **WB400-BGSM:**

**Width:** 140mm **Depth:** 230mm **Height:** 435mm  
or with a larger blown glass, **WB400-BGL:**

**Width:** 140mm **Depth:** 255mm **Height:** 510mm

The Medford is also available as a brass casting, the Bellmore model, in varying sizes, WB100-BGS, WB300-BGM, WB-300-BGL, with a larger range of finishes.



### WB300-BGM-E

Bellmore Cast brass wall bracket shown in polished brass. Includes medium blown glass with brass ring and finial. Hand finished in either polished brass (-PB), old brass (-OB), black bronze (-BB), antique bronze (-AB), antique nickel (-AN), bright chrome (-BC) or powder coated (-PC).

**Wiring:** 1x B22 (BC), 60 watt maximum globe holder(s).  
Meets IP44 standards.

**Width:** 140mm **Depth:** 230mm **Height:** 435mm

Also available in a smaller size, **WB100-BGS:**  
**Width:** 140mm **Depth:** 185mm **Height:** 350mm

or with larger glass, ring and finial, **WB300-BGL:**  
**Width:** 140mm **Depth:** 255mm **Height:** 510mm

The Bellmore is also available in a powder coated satin black aluminium fitting as the Medford model in varying sizes, WB200-BGS, WB400-BGM, WB400-BGL.



### WB35-E

Magill exterior wall bracket shown in antique bronze with a **SMC11-AB** shade. Hand finished in either old brass (-OB), antique bronze (-AB), iron rust (-IR), satin nickel (-SN), or powder coated (-PC).

**Wiring:** 1x B22 (BC), 60 watt maximum globe holder(s).

**Width:** 100mm **Depth:** 290mm (Meets IP13 standards).



### WB35-E

Magill exterior wall bracket shown in iron rust with a **SML10-IR** shade. Hand finished in either old brass (-OB), antique bronze (-AB), iron rust (-IR), satin nickel (-SN), or powder coated (-PC).

**Wiring:** 1x B22 (BC), 60 watt maximum globe holder(s).

**Width:** 100mm **Depth:** 290mm (Meets IP13 standards).



### WB44-E

Highgate exterior wall bracket shown in antique bronze with an **SML14-AB** shade. Hand finished in either old brass (-OB), antique bronze (-AB), or satin nickel (-AN).

**Wiring:** 1x B22 (BC), 60 watt maximum globe holder(s).

**Width:** 100mm (Meets IP13 standards).



### WB35-G2DS-E

Magill exterior wall bracket with an integrated **G2DS** gallery, shown in antique bronze with a **SGC10-OG** shade. Hand finished in either polished brass (-PB), old brass (-OB), black bronze (-BB), antique bronze (-AB), antique nickel (-AN), bright chrome (-BC), iron rust (-IR) or powder coated (-PC).

**Wiring:** 1x B22 (BC), 60 watt maximum globe holder(s).

**Width:** 100mm **Depth:** 290mm (Meets IP13 standards).



### WB36-E

St. Louis sign light wall bracket shown in powdercoated gloss black with a **SMC10-PC** gloss black shade. Waterproof back plate.

**Wiring:** 1x B22 (BC), 60 watt maximum globe holder(s).

**Width:** 100mm



### WB37-E

Mackinnon exterior wall bracket shown in old brass with an **SMD150-OB** shade. Hand finished in either polished brass (-PB), old brass (-OB), black bronze (-BB), antique bronze (-AB), antique nickel (-AN), or bright chrome (-BC).

**Wiring:** 1x B22 (BC), 60 watt maximum globe holder(s).

**Width:** 100mm **Depth:** 620mm **Height:** 620mm (Meets IP13 standards).



### WB38-E

Kentish exterior wall bracket shown in antique nickel with an **SMC150-AN** shade. Hand finished in either polished brass (-PB), old brass (-OB), black bronze (-BB), antique bronze (-AB), antique nickel (-AN), or bright chrome (-BC).

**Wiring:** 1x B22 (BC), 60 watt maximum globe holder(s).

**Width:** 100mm **Depth:** 570mm **Height:** 570mm (Meets IP13 standards).





### WBSN-E

McLaren exterior wall bracket shown in powder coated indian red with an **SMC8-PC** indian red shade.

**Wiring:** 1x B22 (BC), 60 watt maximum globe holder(s).

**Width:** 100mm **Depth:** 210mm **Height:** 125mm  
(Meets IP13 standards).



### WBUGC-E

Coromandel exterior wall bracket shown in powder coated heritage green with an **SMC8-PC** green shade.

**Wiring:** 1x B22 (BC), 60 watt maximum globe holder(s).

**Width:** 100mm **Depth:** 210mm **Height:** 325mm  
(Meets IP13 standards).



### WBSN-G3DS-E

McLaren exterior wall bracket with an integrated **G3DS** gallery, shown in powder coated gloss black with an **S211** glass shade. Hand finished in either polished brass (-PB), old brass (-OB), black bronze (-BB), antique bronze (-AB), antique nickel (-AN), bright chrome (-BC), or powder coated (-PC).

**Wiring:** 1x B22 (BC), 60 watt maximum globe holder(s).

**Width:** 100mm  
**Depth:** 210mm  
**Height:** 145mm  
(Meets IP44 standards).



### WBSN-G3DS-E

McLaren exterior wall bracket with an integrated **G3DS** gallery, shown in powder coated gloss black with an **SPH150-OG** glass shade. Hand finished in either polished brass (-PB), old brass (-OB), black bronze (-BB), antique bronze (-AB), antique nickel (-AN), bright chrome (-BC), or powder coated (-PC).

**Wiring:** 1x B22 (BC), 60 watt maximum globe holder(s).

**Width:** 100mm **Depth:** 210mm  
**Height:** 145mm (Meets IP44 standards).

### WBGN-E

Regent exterior wall bracket shown in powder coated classic cream with an **SMC8-PC** cream shade.

**Wiring:** 1x B22 (BC), 60 watt maximum globe holder(s).

**Width:** 100mm **Depth:** 240mm **Height:** 120mm  
(Meets IP13 standards).



### WB34SN-E

Kew exterior wall bracket shown in powder coated heritage green with an **SMC10-PC** green shade.

**Wiring:** 1x B22 (BC), 60 watt maximum globe holder(s).

**Width:** 100mm  
**Depth:** 300mm  
(Meets IP13 standards).





### WBH2-E

Paddington exterior wall bracket shown in antique bronze with a **SMC11-AB** shade.

**Wiring:** 1x B22 (BC), 60 watt maximum globe holder(s).

**Width:** 100mm **Depth:** 290mm  
**Height:** 130mm  
(Meets IP13 standards).



### WBR2DS-E

Clarendon exterior wall bracket shown in powder coated gloss black with an **SMC10-PC** gloss black shade. Hand finished in either polished brass (-PB), old brass (-OB), black bronze (-BB), antique bronze (-AB), antique nickel (-AN), bright chrome (-BC), or powder coated (-PC).

**Wiring:** 1x B22 (BC), 60 watt maximum globe holder(s).

**Width:** 100mm **Depth:** 230mm **Height:** 120mm  
(Meets IP13 standards).



### WBZ1080

Hamlet die cast wall bracket picture light shown in polished brass. Hand finished in either polished brass (-PB), old brass (-OB), black bronze (-BB), antique bronze (-AB), antique nickel (-AN), bright chrome (-BC) or powder coated (-PC). 90mm die cast back plate.

**Wiring:** 2x B22 (BC), 40 watt maximum globe holder(s).  
**Width:** 305mm **Depth:** 220mm **Height:** 150mm.

### WBPL

Vincent wall bracket picture light shown in polished brass. Hand finished in either polished brass (-PB), old brass (-OB), black bronze (-BB), antique bronze (-AB), antique nickel (-AN), bright chrome (-BC) or powder coated (-PC). 80mm pressed back plate.

**Wiring:** 2x B22 (BC), 40 watt maximum globe holder(s).  
**Width:** 330mm **Depth:** 210mm **Height:** 180mm.



### WBPL600

Vincent wide wall bracket picture light shown in polished brass. Hand finished in either polished brass (-PB), old brass (-OB), black bronze (-BB), antique bronze (-AB), antique nickel (-AN), bright chrome (-BC) or powder coated (-PC).

**Wiring:** 3x B22 (BC), 40 watt maximum globe holder(s).

**Width:** 600mm **Depth:** 210mm **Height:** 180mm.  
**Back plate dimensions:** **Width:** 250mm **Height:** 57mm.



### SM7-140-6

Surface mount with 140mm disk and deep globe holder, shown in bright chrome with 1x **VIN-G95-60-B22** (globe, separate item, left) and with 1x **VIN-ST64-60-B22** (globe, separate item, right). Hand finished in either polished brass (-PB), old brass (-OB), black bronze (-BB), antique bronze (-AB), antique nickel (-AN), satin nickel (-SN), bright nickel (-BN), bright chrome (-BC), or powder coated (-PC).

**Wiring:** 1x B22 (BC), 60 watt maximum globe holder(s).

**Width:** 140mm **Height:** 140mm

### SM7-300-6

Surface mount with 300mm disk and deep globe holder, shown in satin nickel with 1x **VIN-G125-60-B22** (globe, separate item). Hand finished in either polished brass (-PB), old brass (-OB), black bronze (-BB), antique bronze (-AB), antique nickel (-AN), satin nickel (-SN), bright nickel (-BN), bright chrome (-BC), or powder coated (-PC).

**Wiring:** 1x B22 (BC), 60 watt maximum globe holder(s).

**Width:** 300mm **Height:** 300mm

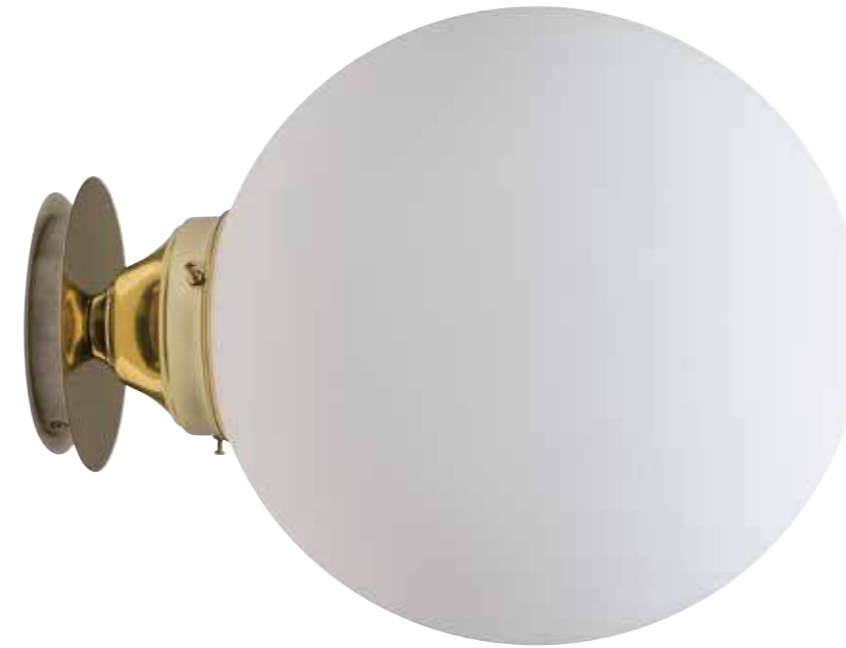

### SM7-140-G4DS

Surface mount with 140mm disk and integrated G4DS gallery, shown in polished brass with a **SPH300-OM** glass shade (separate item). Hand finished in either polished brass (-PB), old brass (-OB), black bronze (-BB), antique bronze (-AB), antique nickel (-AN), satin nickel (-SN), bright nickel (-BN), bright chrome (-BC), or powder coated (-PC).

**Wiring:** 1x B22 (BC), 60 watt maximum globe holder(s).

**Width:** 140mm **Height:** 140mm

Also available with larger 300mm disk (SM7-300-G4DS).

### SM7-300-G3S

Surface mount with 300mm disk and integrated G3S gallery, shown in old brass with a **SPH150-OG** glass shade (separate item). Hand finished in either polished brass (-PB), old brass (-OB), black bronze (-BB), antique bronze (-AB), antique nickel (-AN), satin nickel (-SN), bright nickel (-BN), bright chrome (-BC), or powder coated (-PC).

**Wiring:** 1x B22 (BC), 60 watt maximum globe holder(s).

**Width:** 300mm **Height:** 300mm

Also available with smaller 140mm disk (SM7-140-G3S).





**WBU6**

Carrington wall bracket shown in polished brass with a **G4** polished brass gallery and an **SPH150-OG** shade. Hand finished in either polished brass (-PB), old brass (-OB), black bronze (-BB), antique bronze (-AB), antique nickel (-AN), bright chrome (-BC), or powder coated (-PC).  
**Wiring:** 1x B22 (BC), 60 watt maximum globe holder(s).  
**Width:** 100mm **Depth:** 185mm  
**Height:** 200mm

**WBU3**

Gawler wall bracket shown in polished brass with an **S1700** shade. Hand finished in either polished brass (-PB), old brass (-OB), black bronze (-BB), antique bronze (-AB), antique nickel (-AN), bright chrome (-BC), or powder coated (-PC).

**Wiring:** 1x B22 (BC), 60 watt maximum globe holder(s).  
**Width:** 80mm **Depth:** 120mm **Height:** 130mm

**WBU6D**

Halifax wall bracket shown in polished brass with a **G3** polished brass gallery and an **SPH150-AE** shade. Hand finished in either polished brass (-PB), old brass (-OB), black bronze (-BB), antique bronze (-AB), antique nickel (-AN), bright chrome (-BC), or powder coated (-PC).

**Wiring:** 1x B22 (BC), 60 watt maximum globe holder(s). **Width:** 80mm **Depth:** 185mm  
**Height:** 200mm



**WBU384**

Leigh wall bracket shown in polished brass with an **S92426** shade. Hand finished in either polished brass (-PB), old brass (-OB), black bronze (-BB), antique bronze (-AB), antique nickel (-AN), bright chrome (-BC), or powder coated (-PC).

**Wiring:** 1x B22 (BC), 60 watt maximum globe holder(s).  
**Width:** 100mm **Depth:** 150mm **Height:** 200mm

**WBSD-2**

Gilles twin wall bracket shown in polished brass with 2x **S1702** shades. Hand finished in either polished brass (-PB), old brass (-OB), black bronze (-BB), antique bronze (-AB), antique nickel (-AN), bright chrome (-BC), or powder coated (-PC).

**Wiring:** 1x B22 (BC), 60 watt maximum globe holder(s).  
**Width:** 420mm **Depth:** 250mm **Height:** 195mm  
Available as a single wall bracket (WBSD)  
**Width:** 100mm **Depth:** 270mm **Height:** 155mm



**WBMD**

Grange wall bracket shown in polished brass with a **G2F** polished brass gallery and an **S03-037** shade. Hand finished in either polished brass (-PB), old brass (-OB), black bronze (-BB), antique bronze (-AB), antique nickel (-AN), bright chrome (-BC), or powder coated (-PC).  
**Wiring:** 1x B22 (BC), 60 watt maximum globe holder(s).



**WBG**

Waymouth wall bracket shown in polished brass with an **S163** shade. Hand finished in either polished brass (-PB), old brass (-OB), black bronze (-BB), antique bronze (-AB), antique nickel (-AN), bright chrome (-BC), or powder coated (-PC).

**Wiring:** 1x B22 (BC), 60 watt maximum globe holder(s).

**Width:** 100mm  
**Depth:** 210mm  
**Height:** 265mm



**WBS**

Gilbert wall bracket shown in polished brass with an **S163** shade. Hand finished in either polished brass (-PB), old brass (-OB), black bronze (-BB), antique bronze (-AB), antique nickel (-AN), bright chrome (-BC), or powder coated (-PC).

**Wiring:** 1x B22 (BC), 60 watt maximum globe holder(s).  
**Width:** 100mm **Depth:** 270mm **Height:** 155mm



**WBGDS**

Hindley wall bracket shown in polished brass with a **G2F** polished brass gallery and an **S2740** shade. Hand finished in either polished brass (-PB), old brass (-OB), black bronze (-BB), antique bronze (-AB), antique nickel (-AN), bright chrome (-BC), or powder coated (-PC).

**Wiring:** 1x B22 (BC), 60 watt maximum globe holder(s).  
**Width:** 100mm **Depth:** 210mm **Height:** 265mm





### WBF

Fisher wall bracket shown in polished brass with an **S1587** shade. Hand finished in either polished brass (-PB), old brass (-OB), black bronze (-BB), antique bronze (-AB), antique nickel (-AN), bright chrome (-BC), or powder coated (-PC).

**Wiring:** 1x B22 (BC), 60 watt maximum globe holder(s).

### WB34R-G2DS

Hindmarsh wall bracket with an integrated **G2DS** gallery, shown in polished brass with an **SGC12-OG** shade. Hand finished in either polished brass (-PB), old brass (-OB), black bronze (-BB), antique bronze (-AB), antique nickel (-AN), bright chrome (-BC), or powder coated (-PC).

**Wiring:** 1x B22 (BC), 60 watt maximum globe holder(s).

**Width:** 100mm **Depth:** 210mm **Height:** 120mm



### WBD67

Liverpool wall bracket shown in polished brass with a **G2F** polished brass gallery and an **S2758** shade. Hand finished in either polished brass (-PB), old brass (-OB), black bronze (-BB), antique bronze (-AB), antique nickel (-AN), bright chrome (-BC), or powder coated (-PC).

**Wiring:** 1x B22 (BC), 60 watt maximum globe holder(s).



### WBUGS

Frome wall bracket shown in polished brass with a **G2F** polished brass gallery and an **S2758** shade. Hand finished in either polished brass (-PB), old brass (-OB), black bronze (-BB), antique bronze (-AB), antique nickel (-AN), bright chrome (-BC), or powder coated (-PC).

**Wiring:** 1x B22 (BC), 60 watt maximum globe holder(s).

**Width:** 100mm **Depth:** 300mm **Height:** 250mm

### WBLS

Pirie wall bracket shown in polished brass with a **G2F** polished brass gallery and an **S2740** shade. Hand finished in either polished brass (-PB), old brass (-OB), black bronze (-BB), antique bronze (-AB), antique nickel (-AN), bright chrome (-BC), or powder coated (-PC).

**Wiring:** 1x B22 (BC), 60 watt maximum globe holder(s).



### WBR2DDC

Clarendon wall bracket with integrated decorative cup shown in polished brass with an **S4745** shade. Hand finished in either polished brass (-PB), old brass (-OB), black bronze (-BB), antique bronze (-AB), antique nickel (-AN), bright chrome (-BC), or powder coated (-PC).

**Wiring:** 1x B22 (BC), 60 watt maximum globe holder(s).

**Width:** 100mm  
**Depth:** 220mm  
**Height:** 130mm





### WBF2-G2GS

Lindfield wall bracket with an integrated **G2GS** gallery, shown in old brass with an **S8044-6** shade. Hand finished in either polished brass (-PB), old brass (-OB), black bronze (-BB), antique bronze (-AB), antique nickel (-AN), bright chrome (-BC), or powder coated (-PC).

**Wiring:** 1x B22 (BC), 60 watt maximum globe holder(s).  
**Width:** 100mm

### WBP2-G2GS

Killara wall bracket with an integrated **G2GS** gallery, shown in old brass with an **S8044-6** shade. Hand finished in either polished brass (-PB), old brass (-OB), black bronze (-BB), antique bronze (-AB), antique nickel (-AN), bright chrome (-BC), or powder coated (-PC).

**Wiring:** 1x B22 (BC), 60 watt maximum globe holder(s).  
**Width:** 100mm



### WBH183-G4GS

Walkerville wall bracket with an integrated **G4GS** gallery, shown in polished brass with an **S94030** shade. Hand finished in either polished brass (-PB), old brass (-OB), black bronze (-BB), antique bronze (-AB), antique nickel (-AN), bright chrome (-BC), or powder coated (-PC).

**Wiring:** 1x B22 (BC), 60 watt maximum globe holder(s)  
**Width:** 90mm **Depth:** 175mm **Height:** 135mm



### WBH183

Walkerville wall bracket shown in polished brass with a **G2F** polished brass gallery and an **S94030** shade. Hand finished in either polished brass (-PB), old brass (-OB), black bronze (-BB), antique bronze (-AB), antique nickel (-AN), bright chrome (-BC), or powder coated (-PC).

**Wiring:** 1x B22 (BC), 60 watt maximum globe holder(s).  
**Width:** 90mm **Depth:** 175mm **Height:** 135mm



### WBT3-G2DS

Hyde wall bracket with an integrated **G2DS** gallery, shown in polished brass with an **SGC10-G** shade. Hand finished in either polished brass (-PB), old brass (-OB), black bronze (-BB), antique bronze (-AB), antique nickel (-AN), bright chrome (-BC), or powder coated (-PC).

**Wiring:** 1x B22 (BC), 60 watt maximum globe holder(s).

**Width:** 100mm  
**Depth:** 370mm  
**Height:** 480mm

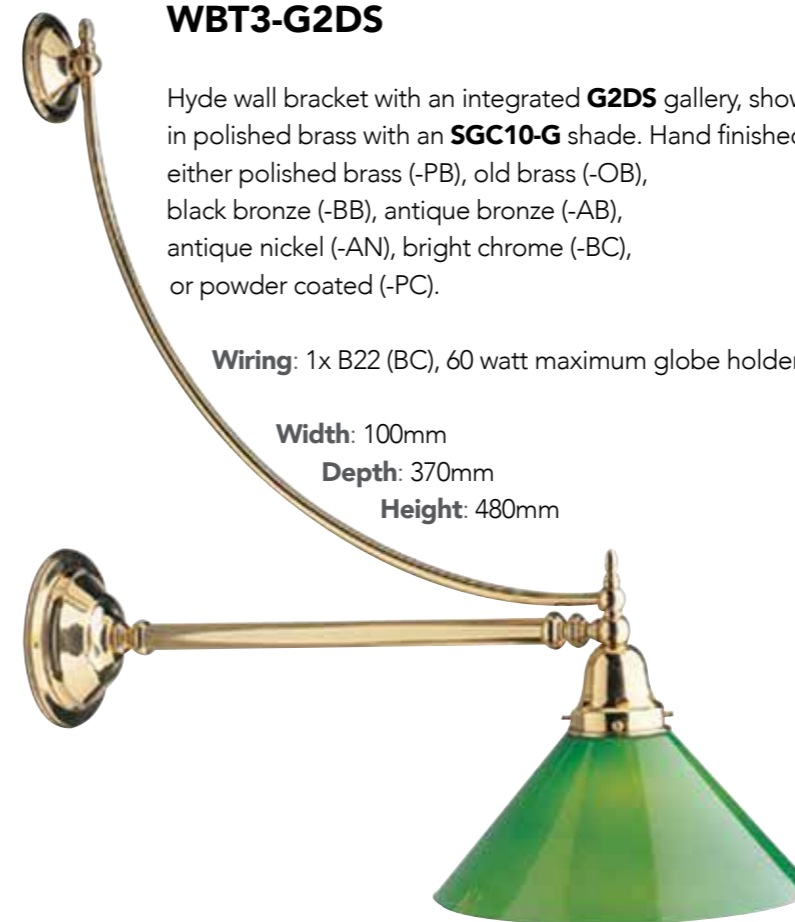

### WBH190

Burnside wall bracket shown in polished brass with a **G2F** polished brass gallery and an **S96928** shade. Hand finished in either polished brass (-PB), old brass (-OB), black bronze (-BB), antique bronze (-AB), antique nickel (-AN), bright chrome (-BC), or powder coated (-PC).

**Wiring:** 1x B22 (BC), 60 watt maximum globe holder(s).  
**Width:** 90mm **Depth:** 220mm **Height:** 210mm



### WBH191

Norwood wall bracket shown in antique nickel with a **G2** antique nickel gallery and an **S1509** shade. Hand finished in either polished brass (-PB), old brass (-OB), black bronze (-BB), antique bronze (-AB), antique nickel (-AN), bright chrome (-BC), or powder coated (-PC).

**Wiring:** 1x B22 (BC), 60 watt maximum globe holder(s).

**Width:** 90mm  
**Depth:** 220mm  
**Height:** 210mm

### WBH228

Brighton wall bracket shown in polished brass with a **G3** polished brass gallery and an **S94029** shade. Hand finished in either polished brass (-PB), old brass (-OB), black bronze (-BB), antique bronze (-AB), antique nickel (-AN), bright chrome (-BC), or powder coated (-PC).

**Wiring:** 1x B22 (BC), 60 watt maximum globe holder(s).

**Width:** 90mm **Depth:** 10mm **Height:** 135mm



### WBH288

Glenelg wall bracket shown in polished brass with a **G4G** polished brass gallery and an **S604** shade. Hand finished in either polished brass (-PB), old brass (-OB), black bronze (-BB), antique bronze (-AB), antique nickel (-AN), bright chrome (-BC), or powder coated (-PC).

**Wiring:** 1x B22 (BC), 60 watt maximum globe holder(s).

**Width:** 90mm



### WBA51-G2FS

Malvern wall bracket with an integrated **G2FS** gallery, shown in polished brass with an **S3138** shade. Hand finished in either polished brass (-PB), old brass (-OB), black bronze (-BB), antique bronze (-AB), antique nickel (-AN), bright chrome (-BC), or powder coated (-PC).

**Wiring:** 1x B22 (BC), 60 watt maximum globe holder(s).

**Width:** 110mm **Depth:** 310mm **Height:** 220mm

### WBA50-G4GS

Hawthorn wall bracket with an integrated **G4GS** gallery, shown in polished brass with an **S603** shade. Hand finished in either polished brass (-PB), old brass (-OB), black bronze (-BB), antique bronze (-AB), antique nickel (-AN), bright chrome (-BC), or powder coated (-PC).

**Wiring:** 1x B22 (BC), 60 watt maximum globe holder(s).

**Width:** 110mm **Depth:** 330mm **Height:** 190mm



### WBA53

Aldgate wall bracket shown in polished brass with a **G4G** polished brass cast open gallery and an **S602** shade. Hand finished in either polished brass (-PB), old brass (-OB), black bronze (-BB), antique bronze (-AB), antique nickel (-AN), bright chrome (-BC), or powder coated (-PC).

**Wiring:** 1x B22 (BC), 60 watt maximum globe holder(s).

**Width:** 100mm **Depth:** 210mm

## WB21-2CNDL

Stratford french empire two arm wall bracket shown in bright nickel with white short candle covers. Hand finished in either polished brass (-PB), or bright nickel (-BN).

**Wiring:** 2x E14 (SES), 60 watt maximum globe holder(s).



## WBH27-G3GS

Winged Siren wall bracket with inbuilt cast G3GS open gallery shown in bright nickel with an **S1060** glass shade. Hand finished in either polished brass (-PB), or bright nickel (-BN). Other finishes available.

**Wiring:** 1x B22 (BC), 60 watt maximum globe holder(s).

**Weight:** 1.93Kg. **Width:** 115mm **Depth:** 170mm **Height:** 270mm.



## WBH551-2G3GS

Veneto, Italian diecast brass two arm wall bracket with 2x integrated **G3GS** galleries, shown in antique bronze with 2x **S1060** glass shades. Hand finished in either polished brass (-PB), old brass (-OB), black bronze (-BB), antique bronze (-AB), antique nickel (-AN), bright nickel (-BN), or bright chrome (-BC).

**Wiring:** 2x B22 (BC), 60 watt maximum globe holder(s).

**Width:** 170mm  
**Depth:** 155mm  
**Height:** 360mm  
**Weight:** 1.93Kg.

## WBH551-2CNDL

Juliet, Italian diecast brass two arm wall bracket shown in bright nickel. Hand finished in either polished brass (-PB), old brass (-OB), black bronze (-BB), antique bronze (-AB), antique nickel (-AN), bright nickel (-BN), or bright chrome (-BC).

**Wiring:** 2x E14 (SES), 60 watt maximum globe holder(s).

**Weight:** 1.81Kg. **Width:** 170mm  
**Depth:** 155mm **Height:** 360mm.

Available with B22 candle globe holders as the Rosaline model, (WBH551-2CB22), suits shade.





**WBH427**

Buxton, art deco cast wall bracket shown in black bronze with a **G2** black bronze gallery and an **S3004** glass shade. Hand finished in either polished brass (-PB), old brass (-OB), black bronze (-BB), antique bronze (-AB), antique nickel (-AN), bright nickel (-BN), or bright chrome (-BC).

**Wiring:** 1x B22 (BC), 60 watt maximum globe holder(s).

**Weight:** 1.10Kg. **Width:** 100mm **Depth:** 140mm **Height:** 150mm.



**WBH427-G2GS-CNDL**

Buxton, art deco cast wall bracket with an integrated **G2GS** gallery shown in old brass with an **S901P** glass shade. Hand finished in either polished brass (-PB), old brass (-OB), black bronze (-BB), antique bronze (-AB), antique nickel (-AN), bright nickel (-BN), or bright chrome (-BC).

**Wiring:** 1x E14 (SES), 60 watt maximum globe holder(s).

**Weight:** 1.10Kg. **Width:** 100mm **Depth:** 140mm **Height:** 165mm.

(-AN, -BN & -BC models are made with white candle cover instead of cream).



**WBH463-CB22**

Millswood, art deco cast wall bracket shown in antique bronze. Hand finished in either polished brass (-PB), old brass (-OB), black bronze (-BB), antique bronze (-AB), antique nickel (-AN), bright nickel (-BN), or bright chrome (-BC).

**Wiring:** 1x B22 (BC), 60 watt maximum globe holder(s).

**Weight:** 1.10Kg. **Width:** 100mm **Depth:** 260mm **Height:** 320mm.

Suits shade, (-AN, -BN & -BC models are made with white candle cover instead of cream).



**WB768-G2GS-CNDL**

Hertfordshire wall bracket with an integrated **G2GS** gallery shown in black bronze with an **S901P** glass shade. Hand finished in either polished brass (-PB), old brass (-OB), black bronze (-BB), antique bronze (-AB), antique nickel (-AN), bright nickel (-BN), or bright chrome (-BC).

**Wiring:** 1x E14 (SES), 60 watt maximum globe holder(s).

**Width:** 125mm **Depth:** 150mm **Height:** 405mm. **Weight:** 3.25Kg.

(-AN, -BN & -BC models are made with a white candle cover).



**WB768**

Hertfordshire wall bracket shown in bright nickel with an **S5-WSQ** shade. Hand finished in either polished brass (-PB), old brass (-OB), black bronze (-BB), antique bronze (-AB), antique nickel (-AN), bright nickel (-BN), or bright chrome (-BC).

**Wiring:** 1x B22 (BC), 60 watt maximum globe holder(s).

**Width:** 125mm **Depth:** 150mm **Height:** 370mm. **Weight:** 3.10Kg.





### WB504

Goodwood wall bracket shown in bronze with an **S5-W** shade. Finished in either antique brass (-AB), or bronze (-BZ).

**Wiring:** 1x B22 (BC), 60 watt maximum globe holder(s).

**Width:** 110mm **Depth:** 220mm **Height:** 350mm.



### WB1121-G2GS-CNDL

Blackwood wall bracket with an integrated **G2GS** gallery shown in polished brass with an **S801P** shade. Hand finished in either polished brass (-PB), old brass (-OB), black bronze (-BB), antique bronze (-AB), antique nickel (-AN) or bright chrome (-BC).

**Wiring:** 1x E14 (SES), 60 watt maximum globe holder(s).

**Back plate Width:** 110mm **Height:** 210mm.

### WB42S-G2GS

Wayville square tube wall bracket shown in black bronze with an **S801P** shade. Hand finished in either polished brass (-PB), old brass (-OB), black bronze (-BB), antique bronze (-AB), antique nickel (-AN) or bright chrome (-BC).

**Wiring:** 1x B22 (BC), 60 watt maximum globe holder(s).

**Width:** 110mm  
**Depth:** 260mm  
**Height:** 450mm.



### WBSA145

Mayo swing arm wall bracket shown in antique nickel. Double action. Hand finished in either polished brass (-PB), old brass (-OB), black bronze (-BB), antique nickel (-AN) or bright chrome (-BC).

**Wiring:** 1x B22 (BC), 60 watt maximum globe holder(s).

**Width:** 170mm **Depth:** 50mm - 515mm

Also available in a smaller size WBSA146 (double action) maximum. **Width:** 150mm **Depth:** 50mm - 300mm



### WBSA6030

Lincoln decorative diecast swing arm wall bracket shown in polished brass. Single action. Hand finished in either polished brass (-PB), old brass (-OB), black bronze (-BB), antique nickel (-AN) or bright chrome (-BC).

**Wiring:** 1x B22 (BC), 60 watt maximum globe holder(s).

**Width:** 95mm **Depth:** 50mm - 380mm **Height:** 160mm.

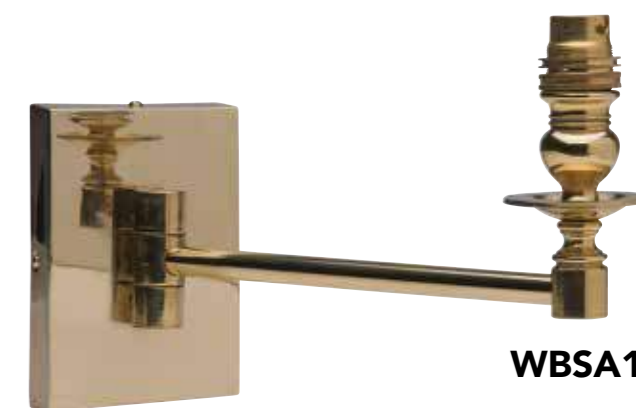

### WBSA144

Mayo swing arm wall bracket shown in polished brass. Single action. Hand finished in either polished brass (-PB), old brass (-OB), black bronze (-BB), antique nickel (-AN) or bright chrome (-BC).

**Wiring:** 1x B22 (BC), 60 watt maximum globe holder(s).

**Width:** 90mm **Depth:** 50mm - 280mm **Height:** 150mm.



### WBSA6031

Lincoln decorative diecast swing arm wall bracket shown in polished brass. Double action. Hand finished in either polished brass (-PB), old brass (-OB), black bronze (-BB), antique nickel (-AN) or bright chrome (-BC).

**Wiring:** 1x B22 (BC), 60 watt maximum globe holder(s).

**Width:** 95mm **Depth:** 50mm - 380mm **Height:** 160mm.



### WBSA147

Library light swing arm wall bracket shown in antique bronze. Hand finished in either antique bronze (-AB), or antique nickel (-AN).

**Wiring:** 1x B22 (BC), 60 watt maximum switched globe holder(s). With two metre cable and plug.

**Width:** 80mm **Depth:** 270mm  
**Height:** 590mm. **Weight:** 3.10Kg.



### WBSAMR

Kenton wall bracket swing arm with metal reflector bearing type shown in satin nickel. Hand finished in either polished brass (-PB), old brass (-OB), black bronze (-BB), antique nickel (-AN) or satin nickel (-SN).

**Wiring:** 1x B22 (BC), 60 watt maximum globe holder(s).

**Depth:** 380mm **Height:** 240mm.  
**Back plate Width:** 80mm **Height:** 125mm.



### WBSA

Kenton wall bracket swing arm bearing type shown in polished brass. Hand finished in either polished brass (-PB), old brass (-OB), black bronze (-BB), antique nickel (-AN) or satin nickel (-SN).

**Wiring:** 1x B22 (BC), 60 watt maximum switched globe holder(s).

**Depth:** 185mm **Height:** 240mm.  
**Back plate Width:** 80mm **Height:** 125mm.

### WBSARA

Blackburn wall bracket swing arm raised arm shown in polished brass. Hand finished in either polished brass (-PB), old brass (-OB), black bronze (-BB), antique nickel (-AN) or satin nickel (-SN).

**Wiring:** 1x B22 (BC), 60 watt maximum globe holder(s).

**Depth:** 295mm **Height:** 185mm.  
**Back plate Width:** 80mm **Height:** 125mm.



### WBSADA

Blackburn wall bracket swing arm double action shown in polished brass. Hand finished in either polished brass (-PB), old brass (-OB), black bronze (-BB), antique nickel (-AN) or satin nickel (-SN).

**Wiring:** 1x B22 (BC), 60 watt maximum globe holder(s).

**Depth:** 380mm  
**Back plate Width:** 80mm **Height:** 125mm.

### WBSASA

Blackburn wall bracket swing arm single action shown in polished brass. Hand finished in either polished brass (-PB), old brass (-OB), black bronze (-BB), antique nickel (-AN) or satin nickel (-SN).

**Wiring:** 1x B22 (BC), 60 watt maximum globe holder(s).

**Back plate Width:** 80mm **Height:** 125mm.

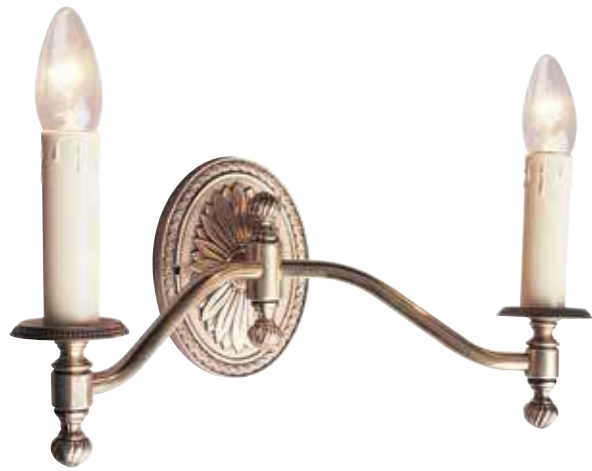

### WBR73-2CNDL

Chelsea twin wall bracket shown in polished brass. Hand finished in either polished brass (-PB), old brass (-OB), black bronze (-BB), antique bronze (-AB), antique nickel (-AN), bright chrome (-BC) or powder coated (-PC).  
Also available in a single wall bracket (WBR73-1CNDL).

**Wiring:** 2x E14 (SES), 60 watt maximum globe holder(s).

**Width:** 300mm **Depth:** 85mm **Height:** 165mm.

(-AN, -BC and -PC) finishes come with white candle covers.



### WBFL-2CNDL

Edward twin wall bracket shown in polished brass. Hand finished in either polished brass (-PB), old brass (-OB), black bronze (-BB), antique bronze (-AB), antique nickel (-AN), bright chrome (-BC) or powder coated (-PC).  
Also available in a single wall bracket (WBFL-1CNDL).

**Wiring:** 2x E14 (SES), 60 watt maximum globe holder(s).

(-AN, -BC and -PC) finishes come with white candle covers.

### WBH132-2CNDL

Netherby twin wall bracket shown in antique bronze. Hand finished in either polished brass (-PB), old brass (-OB), black bronze (-BB), antique bronze (-AB), antique nickel (-AN), bright chrome (-BC), or powder coated (-PC). Also available in a single wall bracket (WBH132-1CNDL).

**Wiring:** 2x E14 (SES), 60 watt maximum globe holder(s).

**Width:** 270mm **Depth:** 120mm **Height:** 135mm.  
(-AN, -BC and -PC) finishes come with white candle covers.



### WB01-2CNDL

Glenbrook twin wall bracket shown in old brass. Hand finished in either polished brass (-PB), old brass (-OB), black bronze (-BB), antique bronze (-AB), antique nickel (-AN), bright chrome (-BC) or powder coated (-PC). Also available in a single wall bracket (WB01-1CNDL).

**Wiring:** 2x E14 (SES), 60 watt maximum globe holder(s).

**Width:** 180mm **Depth:** 110mm **Height:** 140mm.

(-AN, -BC and -PC) finishes come with white candle covers.



### WBU4D-2CNDL

Hurtle twin wall bracket shown in antique bronze. Hand finished in either polished brass (-PB), old brass (-OB), black bronze (-BB), antique bronze (-AB), antique nickel (-AN), bright chrome (-BC) or powder coated (-PC).  
Also available in a single wall bracket (WBU4D-1CNDL).

**Wiring:** 2x E14 (SES), 60 watt maximum globe holder(s).

**Width:** 270mm  
**Depth:** 160mm  
**Height:** 145mm.  
100mm pressed back plate.

(-AN, -BC and -PC) finishes come with white candle covers.



### WBFL-CRYS-2CNDL

Dover twin wall bracket shown in old brass. Hand finished in either polished brass (-PB), old brass (-OB), black bronze (-BB), antique bronze (-AB), antique nickel (-AN), bright chrome (-BC) or powder coated (-PC).  
Also available in a single wall bracket, (WBFL-CRYS-1CNDL).

**Wiring:** 2x E14 (SES), 60 watt maximum globe holder(s).

**Width:** 270mm **Depth:** 120mm **Height:** 135mm.

Made with Egyptian lead crystal.  
(-AN, -BC and -PC) finishes come with white candle covers.



### WBS31

Wall bracket including frosted glass shade shown in antique nickel.  
Hand finished in either polished brass (-PB), old brass (-OB), black bronze (-BB), antique bronze (-AB), antique nickel (-AN), or bright chrome (-BC).

**Wiring:** 1x B22 (BC), 60 watt maximum globe holder(s).

**Width:** 300mm **Depth:** 150mm

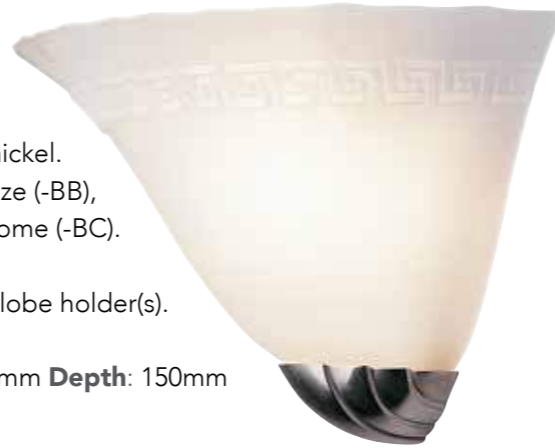

### WBS28-OM

Wall bracket including opal matt glass shade shown in antique nickel. Hand finished in either polished brass (-PB), old brass (-OB), black bronze (-BB), antique bronze (-AB), antique nickel (-AN), or bright chrome (-BC).

**Wiring:** 1x B22 (BC), 60 watt maximum globe holder(s).

**Width:** 300mm **Depth:** 150mm  
Also available with acid frost glass (WBS28AF)

### WBS27-OM

Wall bracket including opal matt glass shade shown in antique nickel. Hand finished in either polished brass (-PB), old brass (-OB), black bronze (-BB), antique bronze (-AB), antique nickel (-AN), or bright chrome (-BC).

**Wiring:** 1x B22 (BC), 60 watt maximum globe holder(s).

**Width:** 300mm **Depth:** 150mm  
Also available with acid frost glass (WBS278AF)



### WBS33

Wall bracket including acid frost glass shade shown in polished brass. Hand finished in either polished brass (-PB), old brass (-OB), black bronze (-BB), antique bronze (-AB), antique nickel (-AN), or bright chrome (-BC).

**Wiring:** 1x B22 (BC), 60 watt maximum globe holder(s).

**Width:** 250mm **Depth:** 75mm

Also available with a larger glass (WBS33L).  
**Width:** 300mm **Depth:** 85mm

### WBS2837

Flash gold wall bracket including frosted glass shade.

**Wiring:** 1x B22 (BC), 60 watt maximum globe holder(s).



### WBS2789

Wall bracket including fluted frosted glass shade shown in polished brass. Hand finished in either polished brass (-PB), old brass (-OB), black bronze (-BB), antique bronze (-AB), antique nickel (-AN), or bright chrome (-BC).

**Wiring:** 1x B22 (BC), 60 watt maximum globe holder(s).



### WBR5-G2GS

Twickenham wall bracket with an integrated **G2GS** gallery. Hand finished in either polished brass (-PB), old brass (-OB), black bronze (-BB), antique bronze (-AB), antique nickel (-AN), or bright chrome (-BC).

**Wiring:** 1x B22 (BC), 60 watt maximum globe holder(s).

**Width:** 100mm **Depth:** 120mm



Shown in antique bronze with an **S1017-O** shade.



Shown in antique nickel with an **S1017-C** shade.

Shown in antique bronze with an **S1801-C** shade.



Shown in antique nickel with an **S1801-O** shade.

### WBR4-CNDL

Verandah wall bracket shown in antique bronze. Hand finished in either polished brass (-PB), old brass (-OB), black bronze (-BB), antique bronze (-AB), antique nickel (-AN), or bright chrome (-BC). (-AN and -BC) finishes come with white candle covers.

**Wiring:** 1x E14 (SES), 60 watt maximum globe holder(s).

**Width:** 100mm **Depth:** 120mm



### WBR5-3SPYS

Twickenham wall bracket with an integrated 3 way spider, shown in bright chrome with an **S6752T** shade. Hand finished in either polished brass (-PB), old brass (-OB), black bronze (-BB), antique bronze (-AB), antique nickel (-AN), or bright chrome (-BC).

**Wiring:** 1x B22 (BC), 60 watt maximum globe holder(s).

**Width:** 100mm **Depth:** 120mm

### WBR4-CB22

Verandah wall bracket shown in antique bronze with an **S152-WL** shade. Hand finished in either polished brass (-PB), old brass (-OB), black bronze (-BB), antique bronze (-AB), antique nickel (-AN), or bright chrome (-BC).

**Wiring:** 1x B22 (BC), 60 watt maximum globe holder(s).

**Width:** 100mm  
**Depth:** 120mm  
**Height:** 120mm.

White Candle cover with all finishes.



### WBR4-2G2DS

Verandah twin wall bracket shown in bright chrome with 2x **S2515** shades. Hand finished in either polished brass (-PB), old brass (-OB), black bronze (-BB), antique bronze (-AB), antique nickel (-AN), or bright chrome (-BC).

**Wiring:** 2x B22 (BC), 60 watt maximum globe holder(s).

**Width:** 210mm **Depth:** 120mm

### WBRC

Whitmore wall bracket shown in black bronze with an **S92720** glass shade.

Hand finished in either polished brass (-PB), old brass (-OB), black bronze (-BB), antique bronze (-AB), antique nickel (-AN), bright chrome (-BC) or powder coated (-PC).

**Wiring:** 1x B22 (BC), 60 watt maximum globe holder(s).

**Width:** 100mm **Depth:** 160mm **Height:** 120mm.



### WBRC-CNDL

Whitmore wall bracket shown in bright chrome. Hand finished in either polished brass (-PB), old brass (-OB), black bronze (-BB), antique bronze (-AB), antique nickel (-AN), bright chrome (-BC), or powder coated (-PC).

**Wiring:** 1x E14 (SES), 60 watt maximum globe holder(s).

**Width:** 100mm **Depth:** 160mm  
**Height:** 120mm.

(-PB, -OB, -BB and -AB) finishes come with cream candle covers.



### WBM39

Wellington decorative wall bracket shown in antique nickel. Hand finished in either polished brass (-PB), old brass (-OB), black bronze (-BB), antique bronze (-AB), antique nickel (-AN), bright chrome (-BC) or powder coated (-PC).

**Wiring:** 1x B22 (BC), 60 watt maximum globe holder(s).

**Width:** 80mm **Depth:** 110mm **Height:** 120mm.



### WBM40

Wellington wall bracket shown in antique nickel with a **G2** antique nickel gallery and an **S3004** shade. Hand finished in either polished brass (-PB), old brass (-OB), black bronze (-BB), antique bronze (-AB), antique nickel (-AN), bright chrome (-BC) or powder coated (-PC).

**Wiring:** 1x B22 (BC), 60 watt maximum globe holder(s).

**Width:** 80mm **Depth:** 110mm **Height:** 90mm.



### WBM41-CNDL

Wellington wall bracket shown in bright chrome. Hand finished in either polished brass (-PB), old brass (-OB), black bronze (-BB), antique bronze (-AB), antique nickel (-AN), bright chrome (-BC), or powder coated (-PC).

**Wiring:** 1x E14 (SES), 60 watt maximum globe holder(s).

**Width:** 100mm **Depth:** 175mm **Height:** 120mm.

(-PB, -OB, -BB and -AB) finishes come with cream candle covers.



### WB-CP6A

Vintage wall bracket shown in antique bronze with a **VIN-ST64-60-E27** vintage globe. Hand finished in either polished brass (-PB), old brass (-OB), black bronze (-BB), antique bronze (-AB), antique nickel (-AN), bright chrome (-BC), or powder coated (-PC).

**Wiring:** 1x B22 (BC), 60 watt maximum globe holder(s).

**Width:** 80mm



### WB43

Woollahra wall bracket shown in antique bronze with an **SMC150** antique bronze shade. Hand finished in either polished brass (-PB), old brass (-OB), black bronze (-BB), antique bronze (-AB), antique nickel (-AN), bright chrome (-BC), or powder coated (-PC).

**Wiring:** 1x B22 (BC), 60 watt maximum globe holder(s).

**Width:** 80mm

**WBL68**

Callington round tube wall bracket shown in bright chrome with an **S5-W** silk shade available in bright chrome (-BC), and stain nickel (-SN).

**Wiring:** 1x B22 (BC), 60 watt maximum globe holder(s).

**Width:** 105mm  
**Depth:** 180mm  
**Height:** 210mm  
**Back plate Height:** 155mm.



**WBL69**

Callington square tube wall bracket shown in bright chrome with an **S5-B** silk shade available in bright chrome (-BC), and stain nickel (-SN).

**Wiring:** 1x B22 (BC), 60 watt maximum globe holder(s).

**Width:** 105mm  
**Depth:** 180mm  
**Height:** 210mm  
**Back plate Height:** 155mm.



**WB45-G3DS**

Morgan round tube wall bracket shown in bright chrome with an **S2295** shade. Hand finished in either polished brass (-PB), old brass (-OB), black bronze (-BB), antique bronze (-AB), antique nickel (-AN), bright chrome (-BC) or powder coated (-PC).

**Wiring:** 1x B22 (BC), 60 watt maximum globe holder(s).

**Width:** 80mm  
**Depth:** 130mm  
**Height:** 200mm



Murray round tube wall bracket shown in antique bronze with an **S5-WSQ** silk square shade. Hand finished in either polished brass (-PB), old brass (-OB), black bronze (-BB), antique bronze (-AB), antique nickel (-AN), bright chrome (-BC) or powder coated (-PC).

**Wiring:** 1x B22 (BC), 60 watt maximum globe holder(s).

**Width:** 80mm **Depth:** 130mm **Height:** 210mm **Weight:** 1.1Kg **Back plate Height:** 125mm.

**WBR3**



**WBL6037**

Bright chrome wall bracket with included glass shade. Available only in bright chrome.

**Wiring:** 1x E27 (ES), 60 watt maximum globe holder(s).

**Height:** 295mm **Depth:** 140mm  
**Back plate diameter:** 120mm

READY TO SHIP

**WB2978-2**

Two light plumbing wall bracket, available only in galvanised bronze. Shown with 2x **VIN-ST64-E27** vintage globes.

**Wiring:** 2x E27 (ES), 60 watt maximum globe holder(s).

**Height:** 150mm

READY TO SHIP

READY TO SHIP

**WB2978-1**

Plumbing wall bracket, available only in galvanised bronze. Shown with a **VIN-T45-E27** vintage globes.

**Wiring:** 1x E27 (ES), 60 watt maximum globe holder(s).

**Height:** 150mm



To highlight a particular area of your room with subtle, subdued lighting, the use of shades is a perfect way to achieve a toned-down ambience. At Robert Kitto, our extensive collection of light shades come in various shapes and colours and, with our variety of materials, there is sure to be a shade to match your desired aesthetic or purpose in a room. Our premium quality products are made from the best materials available, and our designs range from classical to modern, chic styles. The lamp shades reflect the quality and thought put into each of our products, and you will not be disappointed from the choices in our extensive catalogue.

Glass stands as the most popular material for light shades and our extensive range of glass shades, perfectly represent the diversity and versatility of our repertoire. Choose from one of our clear glass shades to achieve a bright diversified illumination, which spreads around large rooms, or select one of our frosted glass designs for a more even and subdued lighting effect. If you like abstract, modern styles, our frosted or coloured glass shades would be a great addition to enhance the overall look and feel of your room.

Among other materials, browse our equally popular metal shades, ranging from stylish satin nickel, which can be powder coated to your choice of colour to match your decor, to durable and affectionate brass shades hand finished in South Australia, also adjustable to suit your setting. Metal shades provide more focused lighting, reflecting more light than glass shades and are ideal in settings such as above bench tops, where bright light is essential. Our designs can fit all requirements from retro themes to modern homes and corporate buildings. Choosing the perfect shade is easy with the large number of high quality options that we provide at Robert Kitto Lighting.

## SMC11-AB

Brass spun conical shade finished in antique bronze.

**Neck:** 30mm (BC)  
**Height:** 85mm.  
**Width:** 290mm  
**Depth:** 290mm



## SMD150

Brass spun side entry dome shade, shown in polished brass. Hand finished in either polished brass (-PB), old brass (-OB), black bronze (-BB), antique bronze (-AB) or antique nickel (-AN), bright chrome (-BC).

**Neck:** 30mm (BC) **Height:** 90mm.  
**Width:** 150mm **Depth:** 150mm



## SMC150

Brass spun conical shade, shown in old brass. Hand finished in either polished brass (-PB), old brass (-OB), black bronze (-BB), antique bronze (-AB), antique nickel (-AN) or bright chrome (-BC).

**Neck:** 30mm (BC)  
**Height:** 170mm.  
**Width:** 170mm  
**Depth:** 170mm





### SML10-SN

Steel spun dome shade, finished in satin nickel.  
White inside (underneath).

**Weight:** 0.43Kg. **Neck:** 30mm (BC)  
**Height:** 130mm. **Width:** 240mm **Depth:** 240mm  
Also available in painted colours (SML10-PC)

Also spun in brass, hand finished inside and out in old brass (-OB), antique bronze (-AB) or iron rust (-IR)

### SML14-OB

Brass spun dome shade, shown in old brass.  
Hand finished in either old brass (-OB),  
antique bronze (-AB) or iron rust (-IR).

**Neck:** 30mm (BC) **Height:** 165mm.  
**Width:** 360mm **Depth:** 360mm  
**Weight:** 0.72Kg.

Also spun in steel, and finished in  
satin nickel (SML14-SN) or available  
in painted colours (SML10-PC).  
White inside (underneath).



### SML18-AB

Brass spun dome shade, shown in antique  
bronze. Hand finished in either  
old brass (-OB), antique bronze (-AB),  
or iron rust (-IR).

**Neck:** 30mm (BC)  
**Height:** 220mm.  
**Width:** 460mm  
**Depth:** 460mm  
**Weight:** 1.48Kg.

Also spun in steel,  
and finished in  
satin nickel  
(SML14-SN).  
White inside (underneath).



### SMC8-PC

Painted steel conical shade.

**Weight:** 0.1Kg. **Neck:** 30mm (BC)  
**Height:** 85mm. **Width:** 220mm **Depth:** 220mm

Shown in matt black (white inside). Also available in  
other painted colours or in satin nickel (SMC8-SN)



### SMC10-PC Green

Painted steel conical shade.

**Weight:** 0.31Kg. **Neck:** 30mm (BC)  
**Height:** 110mm. **Width:** 260mm **Depth:** 260mm.

Shown in green (white inside). Also available in other  
painted colours or in satin nickel (SMC10-SN).

### SMC12-PC White

Painted steel conical shade.

**Weight:** 0.23Kg. **Neck:** 30mm (BC)  
**Height:** 130mm. **Width:** 310mm  
**Depth:** 310mm

Shown in white (white inside). Also available  
in other painted colours or in satin nickel  
(SMC12-SN).



### SMC14-SN

Steel conical shade, finished in  
satin nickel  
White inside (underneath).

**Weight:** 0.66Kg. **Neck:** 30mm  
(BC)  
**Height:** 150mm. **Width:**  
370mm **Depth:** 370mm  
Also available in painted  
colours (SMC14-PC).



**S152-BL**

Six inch black round linen bottom mount shade.  
Top dimensions 89mm diameter.

**Width:** 152mm **Depth:** 152mm **Height:** 178mm.  
**Neck:** 30mm (BC), **Weight:** 0.2Kg.



**S5-WSQ**

Five inch white square silk bottom mount shade.  
Top dimensions 85mm x 85mm.

**Width:** 125mm **Depth:** 125mm **Height:** 125mm.  
**Neck:** 30mm (BC), **Weight:** 0.1Kg.



**S152-WL**

Six inch white round linen bottom mount shade.  
Top dimensions 89mm diameter.

**Width:** 152mm **Depth:** 152mm **Height:** 178mm.  
**Neck:** 30mm (BC), **Weight:** 0.2Kg.



**S5**

Five inch white round silk bottom mount shade.  
Top dimensions 85mm diameter.

**Width:** 125mm **Depth:** 125mm **Height:** 125mm.  
**Neck:** 30mm (BC), **Weight:** 0.1Kg.

Available in white (-W), black (-B) and cream (-C).



**S1801-C**

Clear rounded glass.

**Neck:** 57mm (G2) **Height:** 180mm.  
**Width:** 180mm **Depth:** 180mm



**S1017-OG**

Opal gloss conical glass.

**Neck:** 57mm (G2) **Height:** 170mm.  
**Width:** 170mm **Depth:** 170mm

Also available in clear (S1017-C).

**S1801-OG**

Opal gloss rounded glass.

**Neck:** 57mm (G2) **Height:** 180mm.  
**Width:** 180mm **Depth:** 180mm



**S1029**

Clear conical glass.

**Neck:** 57mm (G2) **Height:** 290mm.  
**Width:** 290mm **Depth:** 290mm

Also available in opal gloss (S1030).

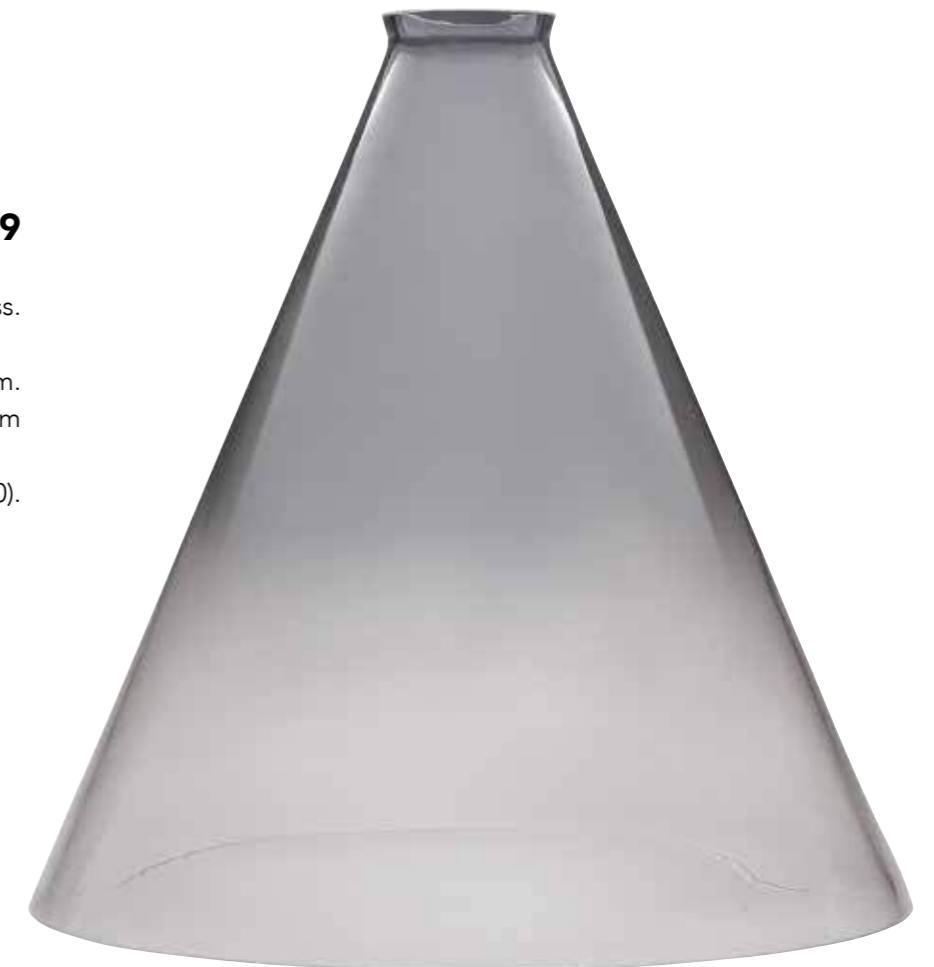



**S1020-OG**

Opal gloss conical glass.

**Neck:** 30mm (BC)  
**Height:** 70mm. **Width:** 200mm **Depth:** 200mm  
Also available in green (S1020-G).



**S1044**

Clear conical glass.

**Neck:** 83mm (G3)  
**Height:** 440mm. **Width:** 440mm  
**Depth:** 440mm

**SGC10-C**

Cream conical glass.

**Neck:** 57mm (G2) **Height:** 115mm. **Width:** 250mm **Depth:** 250mm

Also available in two larger sizes (SGC12-C) and (SGC14-C).  
(SGC12-C) **Height:** 140mm. **Width:** 300mm **Depth:** 300mm  
(SGC14-C) **Height:** 150mm. **Width:** 350mm **Depth:** 350mm



**SGC10-OG**

Opal gloss conical glass.

**Neck:** 57mm (G2) **Height:** 115mm. **Width:** 250mm **Depth:** 250mm

Also available in two larger sizes (SGC12-OG) and (SGC14-OG).  
(SGC12-OG) **Height:** 140mm. **Width:** 300mm **Depth:** 300mm  
(SGC14-OG) **Height:** 150mm. **Width:** 350mm **Depth:** 350mm



**SGC10-G**

Green conical glass.

**Neck:** 57mm (G2) **Height:** 115mm. **Width:** 250mm **Depth:** 250mm

Three other sizes available (SGC8-G) (SGC12-G) and (SGC14-G).  
(SGC8-G) **Height:** 100mm. **Width:** 200mm **Depth:** 200mm  
(SGC12-G) **Height:** 140mm. **Width:** 300mm **Depth:** 300mm  
(SGC14-G) **Height:** 150mm. **Width:** 350mm **Depth:** 350mm



**SGC10-OM**

Opal matt conical glass.

**Neck:** 57mm (G2) **Height:** 115mm. **Width:** 250mm **Depth:** 250mm

Also available in two larger sizes (SGC12-OM) and (SGC14-OM).  
(SGC12-OM) **Height:** 140mm. **Width:** 300mm **Depth:** 300mm  
(SGC14-OM) **Height:** 150mm. **Width:** 350mm **Depth:** 350mm



**SGC10-A**

Amber conical glass.

**Neck:** 57mm (G2) **Height:** 115mm. **Width:** 250mm **Depth:** 250mm  
Also available in two larger sizes (SGC12-A) and (SGC14-A).

(SGC12-A) **Height:** 140mm. **Width:** 300mm **Depth:** 300mm  
(SGC14-A) **Height:** 150mm. **Width:** 350mm **Depth:** 350mm





**S6835-W**

Round glass bowl.  
**Height:** 90mm.  
**Width:** 350mm  
**Depth:** 350mm  
**Neck:** 3x10mm holes for studs.

Also available in acid frost (-AF).



**S1565-40**

Round acid frost glass bowl.  
**Height:** 150mm.  
**Width:** 400mm  
**Depth:** 400mm  
**Neck:** 3x10mm holes for studs.

Also available in a larger size S1565-50.

**Width:** 500mm  
**Depth:** 500mm  
**Height:** 200mm.



**S4530**

Round fluted acid frost glass bowl.  
**Height:** 175mm.  
**Width:** 300mm  
**Depth:** 300mm  
**Neck:** 3x4mm holes for studs.

Also available in a larger size, (S4531).

**Height:** 235mm.  
**Width:** 400mm  
**Depth:** 400mm

**S1018**

Round glass acid frost bowl.  
**Width:** 330mm  
**Depth:** 330mm  
**Height:** 110mm.  
**Neck:** 3x4mm holes for studs.



**S128**

Round glass acid frost bowl.  
**Width:** 330mm  
**Depth:** 330mm  
**Height:** 110mm.  
**Neck:** 3x4mm holes for studs.



**S709**

Round acid frost glass bowl.  
**Height:** 135mm.  
**Width:** 300mm  
**Depth:** 300mm  
**Neck:** 3x4mm holes for studs.



**S4972**

Round glass opal matt bowl.

**Width:** 270mm

**Depth:** 270mm

**Height:** 180mm.

**Neck:** 210mm (G8), or gravity hooks.



**S018-AF**

Round glass acid frost bowl.

**Width:** 400mm

**Depth:** 400mm

**Height:** 200mm.

**Neck:** gravity hooks.

Also available in matt opal S018-OM.

And also available in a smaller size,  
(S017-AF) acid frost, (S017-OM) opal matt.

**Height:** 160mm.

**Width:** 300mm

**Depth:** 300mm



**S4528**

Round matt opal glass bowl.

**Height:** 190mm.

**Width:** 300mm

**Depth:** 300mm

**Neck:** 210mm (G8), or gravity hooks.



**S1222-OM**

Round opal matt glass bowl.

**Height:** 180mm.

**Width:** 330mm

**Depth:** 330mm

**Neck:** gravity hooks.

Available in acid frost (S1222-AF).



**S900**

Round opal matt glass bowl.

**Height:** 140mm.

**Width:** 300mm

**Depth:** 300mm

**Neck:** gravity hooks.

Available in a larger size (S920)

**Height:** 180mm.

**Width:** 400mm

**Depth:** 400mm



**S6946**

Round opal matt glass bowl.

**Height:** 200mm.

**Width:** 350mm

**Depth:** 350mm

**Neck:** gravity hooks.





**S76424-AF**

Acid frost glass shade.  
**Height:** 210mm.  
**Width:** 275mm  
**Depth:** 275mm  
**Neck:** 108mm (G4)  
Also available in opal matt (S76424-OM).



**S71191-AF**

Acid frost glass shade.  
**Height:** 420mm. **Width:** 200mm  
**Depth:** 200mm **Neck:** 108mm (G4)  
Also available in opal matt (S71191-OM).



**S016-OM**

Opal matt glass shade.  
**Height:** 200mm.  
**Width:** 260mm  
**Depth:** 260mm  
**Neck:** 108mm (G4)  
Also available in acid frost (S016-AF).



**SVL1**

Acid etched glass shade.  
**Neck:** 108mm (G4)



**S9012**

Opal gloss glass shade  
**Height:** 200mm.  
**Width:** 260mm  
**Depth:** 260mm  
**Neck:** 108mm (G4)

Also available in larger size (S9014).  
**Height:** 360mm.  
**Width:** 400mm  
**Depth:** 400mm  
**Neck:** 159mm (G6)



**S950**

Opal matt glass shade.  
**Height:** 200mm.  
**Width:** 260mm  
**Depth:** 260mm  
**Neck:** 108mm (G4)



**S6032-OM**

Acid frost glass shade  
**Height:** 200mm.  
**Width:** 420mm  
**Depth:** 420mm  
**Neck:** 108mm (G4)  
Also available in acid frost (S6032-AF).





**S601**

Clear cut glass. **Neck:** 108mm (G4)  
**Height:** 115mm. **Width:** 180mm **Depth:** 180mm



**S602**

Frost and clear cut glass. **Neck:** 108mm (G4)  
**Height:** 115mm. **Width:** 180mm. **Depth:** 180mm



**S603**

Clear cut glass. **Neck:** 108mm (G4)  
**Height:** 115mm. **Width:** 180mm **Depth:** 180mm



**S604**

Acid frost cut glass. **Neck:** 108mm (G4)  
**Height:** 115mm. **Width:** 180mm **Depth:** 180mm



**S605**

Acid etched glass. **Neck:** 108mm (G4)  
**Height:** 115mm. **Width:** 180mm **Depth:** 180mm



**S706**

Acid etched glass. **Neck:** 57mm (G2)  
**Height:** 135mm. **Width:** 155mm **Depth:** 155mm



**S501-1**

Clear cut glass.  
**Neck:** 57mm (G2) **Height:** 120mm.  
**Width:** 120mm **Depth:** 120mm



**S501-2**

Frost and clear cut glass.  
**Neck:** 57mm (G2) **Height:** 120mm.  
**Width:** 120mm **Depth:** 120mm



**S501-3**

Clear cut glass.  
**Neck:** 57mm (G2) **Height:** 120mm.  
**Width:** 120mm **Depth:** 120mm



**S501-4**

Acid frost cut glass.  
**Neck:** 57mm (G2) **Height:** 120mm.  
**Width:** 120mm **Depth:** 120mm



**S501-5**

Acid etched glass.  
**Neck:** 57mm (G2) **Height:** 120mm.  
**Width:** 120mm **Depth:** 120mm



**S163**

Double etched glass.  
**Neck:** 30mm (BC)  
**Height:** 120mm.  
**Width:** 130mm  
**Depth:** 130mm



**S165**

Double etched glass.  
**Neck:** 30mm (BC)  
**Height:** 120mm. **Width:** 130mm **Depth:** 130mm



**S1121**

Acid etched glass.  
**Neck:** 45mm (ES)  
**Height:** 220mm.  
**Width:** 275mm  
**Depth:** 275mm



**S1700**

Acid etched glass.  
**Neck:** 30mm (BC)  
**Height:** 120mm. **Width:** 130mm **Depth:** 130mm

Also available with amber tip (S1701), or with ruby tip (S1702).



**S1587**

Pink frosted glass.  
**Neck:** 30mm (BC)  
**Height:** 100mm. **Width:** 135mm **Depth:** 135mm



**S205**

Acid etched glass.  
**Neck:** 30mm (BC)  
**Height:** 100mm. **Width:** 135mm **Depth:** 135mm

Also available in inverse pattern, i.e. clear etched (S204).



**S505**

Acid etched glass.  
**Neck:** 30mm (BC)  
**Height:** 140mm. **Width:** 130mm **Depth:** 130mm

Also available in inverse pattern, i.e. clear etched (S504).

**S1509**

Acid frost and clear glass.  
**Neck:** 57mm (G2)  
**Height:** 95mm. **Width:** 160mm **Depth:** 160mm



**S96930**

Acid ruby glass.  
**Neck:** 57mm (G2)  
**Height:** 90mm. **Width:** 145mm **Depth:** 145mm  
Also available in acid frost (S93254).  
Also available in acid amber (S96928).



**S03-037**

Acid pink glass.  
**Neck:** 57mm (G2)  
**Height:** 110mm. **Width:** 160mm **Depth:** 160mm  
Also available in acid frost (S01-037).



**S404**

Acid frost glass.  
**Neck:** 57mm (G2)  
**Height:** 130mm. **Width:** 130mm **Depth:** 130mm



**S930**

Opal matt glass.  
**Neck:** 57mm (G2)

**Height:** 100mm. **Width:** 150mm **Depth:** 150mm



**S3133**

Acid etched glass.

**Neck:** 57mm (G2)

**Height:** 115mm. **Width:** 180mm **Depth:** 180mm



**S2170**

Opal matt glass.

**Neck:** 57mm (G2)

**Height:** 140mm. **Width:** 160mm **Depth:** 160mm

**S3138**

Acid etched glass.

**Neck:** 57mm (G2)

**Height:** 145mm. **Width:** 180mm **Depth:** 180mm



**S77273-OG**

Opal gloss glass.  
**Neck:** 57mm (G2)

**Height:** 100mm. **Width:** 150mm **Depth:** 150mm  
Also available in acid frost (S77273-AF).



**S2295**

Opal gloss glass.

**Neck:** 83mm (G3)



**S2740**

Acid frost glass.  
**Neck:** 57mm (G2)  
**Height:** 150mm. **Width:** 110mm **Depth:** 110mm



**S93036**

Opal matt glass.  
**Neck:** 57mm (G2)  
**Height:** 140mm. **Width:** 130mm **Depth:** 130mm



**S93039**

Opal matt glass. **Neck:** 57mm (G2)  
**Height:** 130mm. **Width:** 110mm **Depth:** 110mm



**S92719**

Acid frost glass. **Neck:** 57mm (G2)  
**Height:** 140mm. **Width:** 110mm **Depth:** 110mm



**S2758**

Acid frost glass.  
**Neck:** 57mm (G2)  
**Height:** 180mm.  
**Width:** 105mm  
**Depth:** 105mm



**S7598**

Acid pink glass.  
**Neck:** 57mm (G2)  
**Height:** 145mm. **Width:** 140mm **Depth:** 140mm  
Also available in acid frost (S2766).



**S3004**

Acid frost patterned.  
**Neck:** 57mm (G2)  
**Height:** 90mm.  
**Width:** 110mm  
**Depth:** 110mm



**S211**

Opal gloss glass.  
**Neck:** 83mm (G3)  
**Height:** 180mm. **Width:** 140mm **Depth:** 140mm



**S31723**

Opal matt glass.  
**Neck:** 57mm (G2)  
**Height:** 180mm. **Width:** 140mm **Depth:** 140mm



**SPH150-AF**

Acid frost sphere.  
**Neck:** 83mm (G3)  
**Height:** 150mm. **Width:** 150mm **Depth:** 150mm  
Larger sizes available with **Neck:** 108mm (G4)  
SPH200-AF 200mm sphere  
SPH250-AF 250mm sphere



**SPH150-OM**

Opal matt sphere.  
**Neck:** 83mm (G3)  
**Height:** 150mm. **Width:** 150mm **Depth:** 150mm  
Larger sizes available with **Neck:** 108mm (G4)  
SPH200-OM 200mm sphere  
SPH250-OM 250mm sphere  
SPH300-OM 300mm sphere



**SPH150-OG**

Opal gloss sphere.  
**Neck:** 83mm (G3)  
**Height:** 150mm. **Width:** 150mm **Depth:** 150mm  
Larger sizes available with **Neck:** 108mm (G4)  
SPH200-OG 200mm sphere  
SPH250-OG 250mm sphere  
SPH300-OG 300mm sphere



**SPH150-AE**

Acid etched sphere.  
**Neck:** 83mm (G3)  
**Height:** 150mm. **Width:** 150mm **Depth:** 150mm  
Larger sizes available with **Neck:** 108mm (G4)  
SPH200-AE 200mm sphere  
SPH250-AE 250mm sphere

**S801**

Clear diamond cut glass.  
**Neck:** 57mm (G2)  
**Height:** 200mm.  
**Width:** 125mm  
**Depth:** 125mm  
Also available in grape (S802)  
and plain (S801P)



**S1**

Acid diamond cut glass.  
**Neck:** 57mm (G2)  
**Height:** 200mm. **Width:** 125mm **Depth:** 125mm

**S901**

Clear diamond cut glass.

**Neck:** 57mm (G2)  
**Height:** 230mm.  
**Width:** 155mm  
**Depth:** 155mm  
Also available in plain (S901P).



**S902**

Clear grape glass.

**Neck:** 57mm (G2)  
**Height:** 230mm.  
**Width:** 155mm  
**Depth:** 155mm



**S1060**

Acid frost diamond cut glass.  
**Neck:** 83mm (G3)  
**Height:** 170mm. **Width:** 110mm **Depth:** 110mm

**S1061**

Acid frost cut glass.  
**Neck:** 83mm (G3)  
**Height:** 170mm.  
**Width:** 110mm  
**Depth:** 110mm



**S94030**

Acid frost flame glass.  
**Neck:** 108mm (G4)  
**Height:** 240mm. **Width:** 180mm **Depth:** 180mm



**S94029**

Acid frost flame glass.  
**Neck:** 83mm (G3)  
**Height:** 170mm. **Width:** 130mm **Depth:** 130mm



**S2702**

Acid frost cut glass.  
**Neck:** 108mm (G4)  
**Height:** 270mm. **Width:** 180mm **Depth:** 180mm





**S2705**

Acid frost cut glass.  
**Neck:** 108mm (G4)  
**Height:** 270mm. **Width:** 180mm **Depth:** 180mm

**S987**

Acid etched glass with  
10mm hole for F7 finial,  
specify colour.  
**Neck:** 108mm (G4)  
**Height:** 280mm.  
**Width:** 220mm  
**Depth:** 220mm



**S982**

Opal matt glass.  
**Neck:** 210mm (G8)  
**Height:** 190mm.  
**Width:** 250mm  
**Depth:** 250mm



**S190**

Opal gloss glass.  
**Neck:** 57mm (G2)  
**Height:** 100mm. **Width:** 225mm **Depth:** 225mm.

Larger size available (S191).  
**Height:** 125mm. **Width:** 280mm **Depth:** 280mm.



**S1122**

Acid etched glass.  
**Neck:** 108mm (G4)  
**Height:** 275mm. **Width:** 230mm **Depth:** 230mm





**S92720**

Acid frost fluted glass.  
**Neck:** 30mm (BC)  
**Height:** 140mm. **Width:** 120mm **Depth:** 120mm

**S4745**

Acid frost fluted glass.  
**Neck:** 45mm (ES)  
**Height:** 105mm. **Width:** 180mm **Depth:** 180mm  
Also available in two larger sizes.  
(S4746) **Height:** 125mm. **Width:** 300mm **Depth:** 300mm  
(S4747) **Height:** 140mm. **Width:** 400mm **Depth:** 400mm



**S92110**

Acid frost glass. **Neck:** 45mm (ES)  
**Height:** 140mm. **Width:** 300mm **Depth:** 300mm  
Also available in a larger size (S92111).  
**Height:** 140mm. **Width:** 400mm **Depth:** 400mm



**S92137**

Acid frost glass.  
**Neck:** 30mm (BC)  
**Height:** 135mm. **Width:** 95mm **Depth:** 95mm



**S92426**

Acid frost fluted glass.  
**Neck:** 45mm (ES)  
**Height:** 100mm. **Width:** 160mm **Depth:** 160mm



**S310**

Matt opal glass.  
**Neck:** 30mm (BC)  
**Height:** 105mm. **Width:** 180mm **Depth:** 180mm



**S92474**

Acid frost fluted glass.  
**Neck:** 45mm (ES)  
**Height:** 150mm.  
**Width:** 400mm  
**Depth:** 400mm





**S8044-9**

Clear fluted Holophane style glass.  
**Neck:** 57mm (G2)  
**Height:** 150mm. **Width:** 400mm **Depth:** 400mm



**S8044-6**

Clear fluted Holophane style glass.  
**Neck:** 57mm (G2)  
**Height:** 150mm. **Width:** 400mm **Depth:** 400mm



**S2515**

Clear fluted Holophane style glass.  
**Neck:** 57mm (G2)  
**Height:** 105mm. **Width:** 180mm **Depth:** 180mm

**S1550**

Clear fluted Holophane style glass.  
**Neck:** 108mm (G4)  
**Height:** 150mm. **Width:** 300mm **Depth:** 300mm



**S1279**

Clear fluted Holophane style glass.  
**Neck:** 45mm (ES)  
**Height:** 400mm. **Width:** 400mm **Depth:** 420mm





**S40**

Opal gloss schoolhouse style glass.

**Neck:** 159mm (G6)

**Height:** 450mm. **Width:** 400mm **Depth:** 400mm



**S4154**

Opal gloss schoolhouse style glass.

**Neck:** 159mm (G6)

**Height:** 200mm.

**Width:** 400mm

**Depth:** 400mm



**S2250**

Opal gloss schoolhouse style glass.

**Neck:** 108mm (G4)

**Height:** 170mm.

**Width:** 250mm

**Depth:** 250mm

Larger size available (S2400)

**Neck:** 159mm (G6)

**Height:** 230mm.

**Width:** 400mm

**Depth:** 400mm

**S1300**

Opal gloss schoolhouse style glass.

**Neck:** 108mm (G4)

**Height:** 170mm.

**Width:** 300mm

**Depth:** 300mm

Smaller size available (S1100)

**Height:** 150mm.

**Width:** 225mm

**Depth:** 225mm

Larger size available (S1400)

**Neck:** 159mm (G6)

**Height:** 230mm.

**Width:** 400mm

**Depth:** 400mm



The background image shows the interior of a restaurant, likely Bistro Blackwood. It features a series of parallel wooden beams on the ceiling, with multiple strings of warm-toned Edison-style filament globes hanging from them. A glass partition with a dark metal frame runs across the middle of the frame. On the right, a vertical cylindrical light fixture is mounted on a brick pillar, with the word 'BISTRO' written vertically on its glass panels. The overall atmosphere is warm and industrial.

## Accessories, Parts & Globes

Light design is one of the most important aspects of your home décor. For your interiors to look and feel good, it's important to choose not only the right light fittings, but the right accessories and parts. At Robert Kitto, we have a wide range of lighting accessories and parts to bring out the best from your lights. Choose from our extensive selection of galleries and glasses to create the perfect pendant or suspension light. We stock a vast range of cast pressed

and spun brass components as well as a wide selection of electrical and other parts to repair or redesign your light fittings if needed. Whether you want your table light rewired with an in line switch or a switch on the lamp holder instead, Robert Kitto Lighting can repair and adjust your lamps whilst meeting all safety standards and approvals. The first light globe was invented over two hundred years ago, it was dull, expensive

and only lasted a day. It was not until the late 19th century when Thomas Edison made filament globes which lasted over one thousand hours and after George Westinghouse's large-scale manufacturing plant took control, globes were able to be produced on a commercial scale and thus, the electric lighting industry began. Now, 100 years since Edison's filament lights were produced, they are still shining

in style at Robert Kitto Lighting. With all sorts of shapes and sizes the long fine filaments within our vintage globes glow a beautiful bright amber. Now a modern addition, as history repeats, try our vintage globe lights, available with a range of cord suspensions available in many colours and designs. We at Robert Kitto strive to deliver quality and reliability, and our products accessories, and service are sure to satisfy.

VIN-ST64-60-E27 globes shown outside, and S2400 glass shades seen on the interior, at Bistro Blackwood in Adelaide's CBD.

**DL-ZR1078**

Round Italian decorative die cast solid brass downlight shown in old brass with a LED Module.

Recommended for posh cafes, fine dining restaurants, swanky bar bulkheads, European styled villas, or any other space that deserves a quality fitting but lacks the room required for hanging fittings.

Hand finished in either polished brass (-PB), old brass (-OB), black bronze (-BB), antique bronze (-AB), antique nickel (-AN), or bright chrome (-BC).

**Cutout:** 90mm.



**DL-ZR1084**

Square Italian decorative die cast solid brass downlight shown in old brass with a LED Module. Recommended for posh cafes, fine dining restaurants, swanky bar bulkheads, European styled villas, or any other space that deserves a quality fitting but lacks the room required for hanging fittings.

Hand finished in either polished brass (-PB), old brass (-OB), black bronze (-BB), antique bronze (-AB), antique nickel (-AN), or bright chrome (-BC).

**Cutout:** 90mm.



**F1228**

7 Watt Dimmable LED Module. Fits our range of brass downlights as well as being a complete module to retro fit many existing halogen downlights. 80CRI 60 degree beam angle 3000k Warm white 720 lumen output 50 000 hour lifespan.

**Cutout:** 50mm (MR16 size).



**DL6340**



Italian pressed brass downlight shown in bright chrome with a LED Module, Hand finished in either polished brass (-PB), old brass (-OB), black bronze (-BB), antique bronze (-AB), antique nickel (-AN), or bright chrome (-BC).

**Cutout:** 90mm.

**DL6320**



Italian pressed brass downlight shown in black bronze with a LED Module, Hand finished in either polished brass (-PB), old brass (-OB), black bronze (-BB), antique bronze (-AB), antique nickel (-AN), or bright chrome (-BC).

**Cutout:** 90mm.

**DL6240**



Italian pressed brass downlight shown in antique nickel with a LED Module, Hand finished in either polished brass (-PB), old brass (-OB), black bronze (-BB), antique bronze (-AB), antique nickel (-AN), or bright chrome (-BC).

**Cutout:** 90mm.

**DL6320**



Italian pressed brass downlight shown in bright chrome with a LED Module, Hand finished in either polished brass (-PB), old brass (-OB), black bronze (-BB), antique bronze (-AB), antique nickel (-AN), or bright chrome (-BC).

**DL6420**



Italian pressed brass downlight shown in antique nickel with a LED Module, Hand finished in either polished brass (-PB), old brass (-OB), black bronze (-BB), antique bronze (-AB), antique nickel (-AN), or bright chrome (-BC).

**Cutout:** 90mm.

**DL6040**



Italian pressed brass downlight shown in old brass with a LED Module, Hand finished in either polished brass (-PB), old brass (-OB), black bronze (-BB), antique bronze (-AB), antique nickel (-AN), or bright chrome (-BC).

**Cutout:** 90mm.

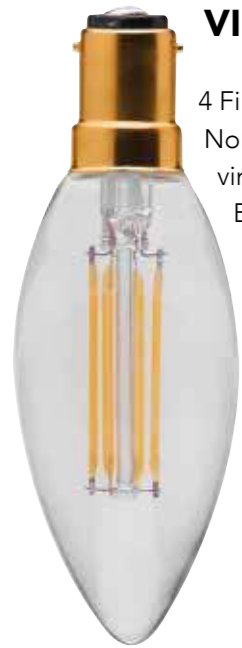

**VIN-LED-C35-B15**

4 Filament,  
Non-Dimmable  
vintage LED globe,  
B15 (SBC) brass base  
240 Volt 0.0133 Amp (3.2 Watt)  
2200 Kelvin (Warm White)  
175 Lumen output.

**VIN-LED-ST64-B22**

Non-Dimmable vintage LED globe,  
B22 (BC) brass base 4 Filaments,  
240 Volt 0.017 Amp (4 Watt)  
2200 Kelvin (Warm White)  
270 Lumen output.



**VIN-LED-ST64-E27**

4 Filament,  
Non-Dimmable  
vintage LED globe,  
E27 (ES) brass base  
240 Volt 0.017 Amp (4 Watt)  
2200 Kelvin (Warm White)  
270 Lumen output.



**VIN-LED-G125-E27**

Non-Dimmable vintage LED globe,  
E27 (ES) brass base 4 Filaments,  
240 Volt 0.017 Amp (4 Watt)  
2200 Kelvin (Warm White)  
270 Lumen output.



**VIN-LED-ST64-B22**

4 Filament  
Non-Dimmable  
vintage LED globe,  
B22 (BC) brass base  
240 Volt 0.017 Amp (4 Watt)  
2200 Kelvin (Warm White)  
270 Lumen output.



**VIN-LED-C35T-B15**

4 Filament,  
Non-Dimmable  
vintage LED globe,  
B15 (SBC) brass base  
240 Volt 0.0133 Amp (3.2 Watt)  
2200 Kelvin (Warm White)  
175 Lumen output.

**VIN-LED-C35-E14**

4 Filament,  
Non-Dimmable  
vintage LED globe,  
E14 (SES) brass base  
240 Volt 0.0133 Amp (3.2 Watt)  
2200 Kelvin (Warm White)  
175 Lumen output.



**VIN-LED-C35T-E14**

4 Filament,  
Non-Dimmable  
vintage LED globe,  
E14 (SES) brass base  
240 Volt 0.0133 Amp (3.2 Watt)  
2200 Kelvin (Warm White)  
175 Lumen output.





**VIN-T9-60-B22**

Vintage incandescent globe  
B22 (BC) brass base 12 Anchors  
240 Volt 0.25 Amp (60 Watt)  
Dimmable



**VIN-ST64-60-B22**

Dimmable vintage incandescent globe,  
B22 (BC) brass base 19 Anchors,  
240 Volt 0.25 Amp (60 Watt)



**VIN-T45-60-B22**

Vintage incandescent globe, B22 (BC) brass base  
15 Anchors, 240 Volt 0.25 Amp (60 Watt) Dimmable



**VIN-ST64-60-E27**

Vintage incandescent globe,  
E27 (ES) brass base 19 Anchors,  
240 Volt 0.25 Amp (60 Watt)  
Dimmable

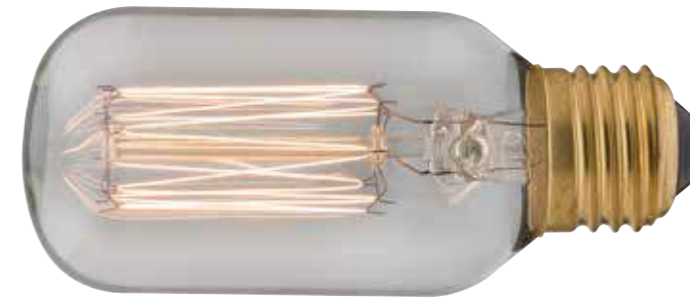

**VIN-T45-60-E27**

Vintage incandescent globe,  
E27 (ES) brass base 15 Anchors,  
240 Volt 0.25 Amp (60 Watt)  
Dimmable



**VIN-T9-60-E27**

Vintage incandescent globe,  
E27 (ES) brass base 12 Anchors,  
240 Volt 0.25 Amp (60 Watt)  
Dimmable





**VIN-G125-60-E27**

Vintage incandescent globe,  
E27 (ES) brass base 29 Anchors,  
240 Volt 0.25 Amp (60 Watt)  
Dimmable



**VIN-G125-60-B22**

Vintage incandescent globe,  
B22 (BC) brass base 29 Anchors,  
240 Volt 0.25 Amp (60 Watt)  
Dimmable



**VIN-G95-60-B22**

Vintage incandescent globe,  
B22 (BC) brass base 29 Anchors,  
240 Volt 0.25 Amp (60 Watt)  
Dimmable.



**VIN-G95D-E27**

Dimmable vintage incandescent globe,  
E27 (ES) brass base 19 Anchors,  
240 Volt 0.17 Amp (40 Watt)  
Diamond Cut.

**VIN-G95-60-E27**

Vintage incandescent globe,  
E27 (ES) brass base 19 Anchors,  
240 Volt 0.25 Amp (60 Watt)  
Dimmable



**VIN-G95B-E27**

Dimmable vintage incandescent globe,  
E27 (ES) brass base 19 Anchors,  
240 Volt 0.17 Amp (40 Watt)  
Balloon shape Cut.



**VIN-G95-SF-E27**

Vintage incandescent globe,  
E27 (ES) brass base Squirrel Filament,  
240 Volt 0.1 Amp (25 Watt)  
Dimmable





250 Volt 7.5 Amp rated black cotton filled flexible cable. 100M roll x 7.5mm diameter double insulated 3 x 0.75mm 24/0.2 strands



250 Volt 7.5 Amp rated brown cotton filled flexible cable. 100M roll x 7.5mm diameter double insulated 3x 0.75mm 24/0.2 strands



250 Volt 7.5 Amp rated gold cotton filled flexible cable. 100M roll x 7.5mm diameter double insulated 3 x 0.75mm 24/0.2 strands



250 Volt 7.5 Amp rated grey cotton filled flexible cable. 100M roll x 7.5mm diameter double insulated 3 x 0.75mm 24/0.2 strands



250 Volt 7.5 Amp rated red cotton filled flexible cable. 100M roll x 7.5mm diameter double insulated 3 x 0.75mm 24/0.2 strands



250 Volt 7.5 Amp rated white cotton filled flexible cable.  
100M roll x 7.5mm diameter double insulated 3 x 0.75mm 24/0.2 strands



250 Volt 7.5 Amp rated B&W cotton filled flexible cable.  
100M roll x 7.5mm diameter double insulated 3 x 0.75mm 24/0.2 strands



250 Volt 7.5 Amp rated black PVC flexible cable. 100M roll x 7.5mm diameter double insulated 3 x 0.75mm 24/0.2 strands



250 Volt 7.5 Amp rated clear PVC flexible cable. 100M roll x 7.5mm diameter double insulated 3 x 0.75mm 24/0.2 strands



250 Volt 7.5 Amp rated gold PVC flexible cable. 100M roll x 7.5mm diameter double insulated 3 x 0.75mm 24/0.2 strands



250 Volt 7.5 Amp rated white PVC flexible cable. 100M roll x 7.5mm diameter double insulated 3 x 0.75mm 24/0.2 strands



250 Volt 7.5 Amp rated black twisted Italian silk flexible cable. 50M roll double insulated 3 x 0.75mm 24/0.2 strands



250 Volt 7.5 Amp rated brown twisted Italian silk flexible cable. 50M roll double insulated 3 x 0.75mm 24/0.2 strands



250 Volt 7.5 Amp rated gold twisted Italian silk flexible cable. 50M roll double insulated 3 x 0.75mm 24/0.2 strands

**CABLE-3CLFBLC**

**CABLE-3CLFBC**

**CABLE-3CLFGC**

**CABLE-3CLFGYC**

**CABLE-3CLFRC**

**CABLE-CLFWC**

**CABLE-3CBW**

**CABLE-3CLFB**

**CABLE-3CLFC**

**CABLE-3CLFG**

**CABLE-3CLFW**

**CABLE-3CT-BLACK**

**CABLE-3CT-BROWN**

**CABLE-3CT-GOLD**



250 Volt 7.5 Amp rated black PVC flat flexible cable. 100M roll x 7.5mm diameter double insulated 2 x 0.75mm 24/0.2 strands



250 Volt 7.5 Amp rated clear PVC flat flexible cable. 100M roll x 7.5mm diameter double insulated 2 x 0.75mm 24/0.2 strands



250 Volt 7.5 Amp rated gold PVC flat flexible cable. 100M roll x 7.5mm diameter double insulated 2 x 0.75mm 24/0.2 strands



250 Volt 7.5 Amp rated white PVC flat flexible cable. 100M roll x 7.5mm diameter double insulated 2 x 0.75mm 24/0.2 strands

**CABLE-2CLFC**



250 Volt 7.5 Amp rated clear PVC flexible cable. 100M roll x 7.5mm diameter double insulated 2 x 0.75mm 24/0.2 strands

**CABLE-2CFB**

**CABLE-2CFC**

**CABLE-2CFG**

**CABLE-2CFW**



**SW-KS1-BLACK**

Black 250 Volt 2.0 Amp rated serviceable cordline switch.



**SW-KS1-CLEAR**

Clear 250 Volt 2.0 Amp rated serviceable cordline switch.



**SW-KS1-GOLD**

Gold 250 Volt 2.0 Amp rated serviceable cordline switch.



**SW-KS1-WHITE**

White 250 Volt 2.0 Amp rated serviceable cordline switch.

**FS-KS2-BLACK**

Black 250 Volt 2.0 Amp rated serviceable cordline foot switch.



**CABLE-3CPSB**

Black 3 core PVC cordset, molded plug, inline switch. 2.5 metres. 250 Volt 7.5 Amp rated, double insulated 3 x 0.75mm 24/0.2 strands.

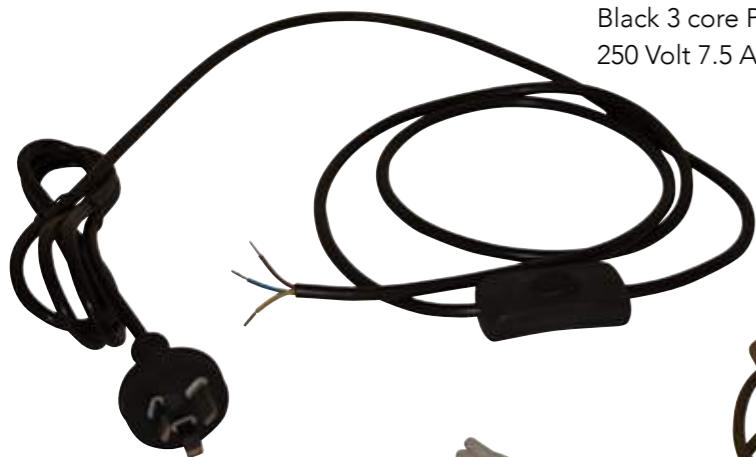

**CABLE-3CPSG**

Gold 3 core PVC cordset, molded plug, inline switch. 2.5 metres. 250 Volt 7.5 Amp rated, double insulated 3 x 0.75mm 24/0.2 strands.



**CABLE-3CPSW**

White 3 core PVC cordset, molded plug, inline switch. 2.5 metres. 250 Volt 7.5 Amp rated, double insulated 3 x 0.75mm 24/0.2 strands.

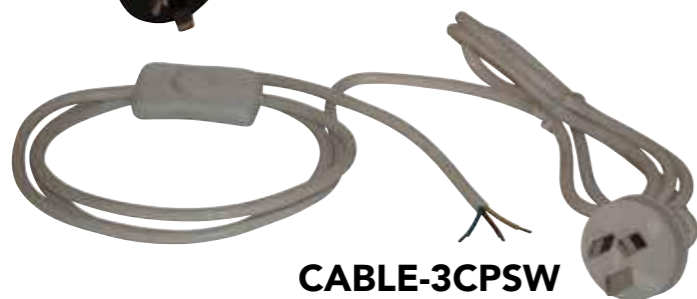

**CABLE-TLCS**

Brown 3 core cotton filled table lamp cordset with molded plug, 2.5 metres, 250 Volt 7.5 Amp rated, double insulated 3 x 0.75mm 24/0.2 strands.



**CABLE-3CPG**

Gold 3 core PVC table lamp cordset with molded plug. 2.5 metres. 250 Volt 7.5 Amp rated, double insulated 3 x 0.75mm 24/0.2 strands. Also available in black (3CPB).

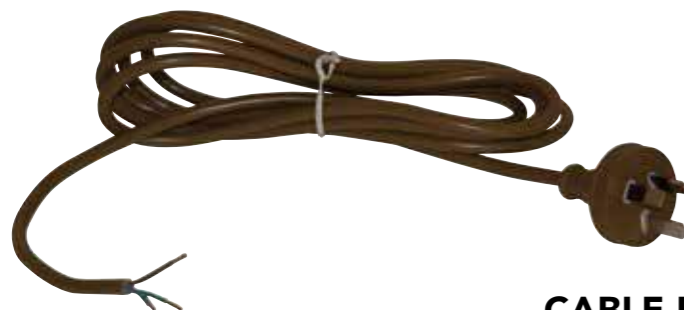

**CABLE-FSCS**

Black 3 core PVC floor lamp cordset with molded plug. 4.0 metres. 250 Volt 7.5 Amp rated, double insulated 3 x 0.75mm 24/0.2 strands.



**CABLE-3CFS**

Black 3 core PVC cordset, molded plug, inline foot switch. 4.3 metres. 250 Volt 2.5 Amp rated, double insulated 3 x 0.75mm 24/0.2 strands.



**CABLE-2CPSG**

Gold 2 core PVC cordset, molded plug, inline switch. 2.5 metres. 250 Volt 7.5 Amp rated, double insulated 2 x 0.75mm 24/0.2 strands.

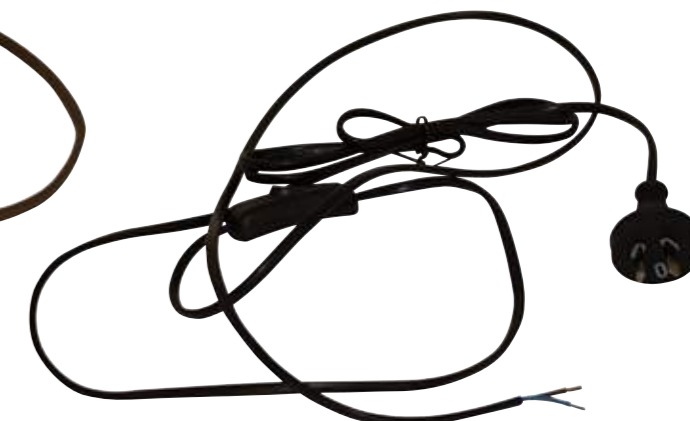

**CABLE-2CPSB**

Black 2 core PVC cordset, molded plug, inline switch. 2.5 metres. 250 Volt 7.5 Amp rated, double insulated 2 x 0.75mm 24/0.2 strands.

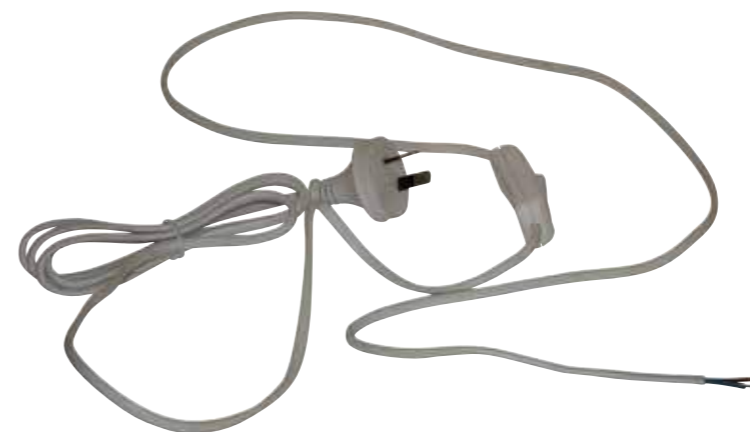

**CABLE-2CPSW**

White 2 core PVC cordset, molded plug, inline switch. 2.5 metres. 250 Volt 7.5 Amp rated, double insulated 2 x 0.75mm 24/0.2 strands.

**CABLE-2C2MB**

Black 2 core PVC cordset with molded plug. 2.5 metres. 250 Volt 7.5 Amp rated, double insulated 2 x 0.75mm 24/0.2 strands.



**CABLE-2C2G**

Gold 2 core PVC cordset with molded plug. 2.5 metres. 250 Volt 7.5 Amp rated, double insulated 2 x 0.75mm 24/0.2 strands.



**CABLE-2C2MC**

Clear 2 core PVC cordset with molded plug. 2.5 metres. 250 Volt 7.5 Amp rated, double insulated 2 x 0.75mm 24/0.2 strands.





**LHGP016C-BRASS**

Brass 5 Piece globe holder Bayonet Cap - B22 (BC) M10x1 entry, no earth. with 30mm shade ring. 250 Volt 2.0 Amp rated. 60 Watt maximum.



**LHGP016C-BRONZE**

Brass 5 Piece globe holder Bayonet Cap - B22 (BC) M10x1 entry, no earth with 30mm shade ring. 250 Volt 2.0 Amp rated. 60 Watt maximum.



**LHGP016C-NICKEL**

Brass 5 Piece globe holder Bayonet Cap - B22 (BC) M10x1 entry, no earth with 30mm shade ring. 250 Volt 2.0 Amp rated. 60 Watt maximum.



**LHGPE27-P**

Aluminium 3 Piece globe holder Bayonet Cap - E27 (ES) 12.7mm 26TPI entry, earthed with plain body no ring. 250 Volt 2.0 Amp rated. 60 Watt maximum.



**LHGPE27-C**

Aluminium 5 Piece globe holder Bayonet Cap - E27 (ES) 12.7mm 26TPI entry, no earth with 45mm shade rings. 250 Volt 2.0 Amp rated. 60 Watt maximum.



**LHGP014P-BRASS**

Brass 4 Piece globe holder Small bayonet cap - B15 (SBC)M10x1 entry, no earth with plain body no ring. 250 Volt 2.0 Amp rated. 60 Watt maximum.



**LHB15-W**

White 4 Piece globe holder Small bayonet cap - B15 (SBC) M10x1 entry, no earth with 30mm shade ring. 250 Volt 2.0 Amp rated. 60 Watt maximum.



**LHGP018C-BRASS**

Brass 5 Piece globe holder Bayonet Cap - B22 (BC) M10x1 entry, earthed. With 30mm shade ring. 250 Volt 2.0 Amp rated. 60 Watt maximum. Available with 12.7mm entry (LHGP018C-12).



**LHGP018C-BRONZE**

Brass 5 Piece globe holder Bayonet Cap - B22 (BC) M10x1 entry, earthed. with 30mm shade ring. 250 Volt 2.0 Amp rated. 60 Watt maximum.



**LHGP018C-NICKEL**

Brass 5 Piece globe holder Bayonet Cap - B22 (BC) M10x1 entry, earthed. with 30mm shade ring. 250 Volt 2.0 Amp rated. 60 Watt maximum.



**LHB22S-B**

Black switched Bayonet Cap globe holder - B22 (BC) M10x1 entry, no earth. with shade ring skirt. 250 Volt 2.0 Amp rated. 60 Watt maximum.



**LHB22S-W**

White switched Bayonet Cap globe holder - B22 (BC) M10x1 entry, no earth. with shade ring skirt. 250 Volt 2.0 Amp rated. 60 Watt maximum.



**LHB22-B**

Black 3 Piece Bayonet Cap globe holder - B22 (BC) M10x1 entry, no earth. with shade ring skirt. 250 Volt 2.0 Amp rated. 60 Watt maximum.



**LHB22-W**

White 3 Piece Bayonet Cap globe holder - B22 (BC) M10x1 entry, no earth. with shade ring skirt. 250 Volt 2.0 Amp rated. 60 Watt maximum.



**LH1413E**

Brass Bayonet Cap switched globe holder - B22 (BC) M10x1 entry, earthed. with plain body no ring. 250 Volt 2.0 Amp rated. 60 Watt maximum.



**LH3413E**

Brass Bayonet Cap switched globe holder - B22 (BC) 12.7mm entry, earthed. with 30mm shade ring. 250 Volt 2.0 Amp rated. 60 Watt maximum.



**LHGP018BT-BRASS**

Brass batten fix globe holder Bayonet Cap - B22 (BC) M10x1 entry, earthed. with 30mm shade ring. 250 Volt 2.0 Amp rated. 60 Watt maximum.



**LHGP05C**

Aluminium 2P Bayonet Cap globe holder - B22 (BC) M10x1 entry, no earth. Golden anodised finish. 250 Volt 2.0 Amp rated. 60 Watt maximum.



**LHE14**

Black 3 Piece globe holder Small Edison screw, E14 (SES) M10x1 entry, no earth. with shade ring skirt. 250 Volt 2.0 Amp rated. 60 Watt maximum.



**LHE27WB**

Plastic globe holder Edison Screw - E27 (ES) L shaped bracket, no earth. with plain body no ring. 250 Volt 2.0 Amp rated. 60 Watt maximum.



**LHE27-B**

Black 4 Piece globe holder Edison Screw - E27 (ES) M10x1 entry, no earth. with 45mm shade ring. 250 Volt 4.0 Amp rated. 60 Watt maximum.



**LHE27-W**

White 4 Piece globe holder Edison Screw - E27 (ES) M10x1 entry, no earth. with 45mm shade ring. 250 Volt 4.0 Amp rated. 60 Watt maximum.



**LHE14L**

Black long 3 piece candle globe holder Small edison screw - E14 (SES). M10x1 integrated lock nut with earth. 250 Volt 2.0 Amp rated. 60 Watt maximum.  
**Height:** 105mm Ø 28mm



**LAGG10-W**

Italian opaque white imitation candle cover for LHE14L globe holder.  
**Height:** 105mm. Ø 30mm.



**LAGG10-C**

Italian opaque cream imitation candle cover for LHE14L globe holder.  
**Height:** 105mm. Ø 30mm.



**LAGG10-A**

Italian opaque antique imitation candle cover for LHE14L globe holder.  
**Height:** 105mm. Ø 30mm.



**BTD105**

Italian brass drip imitation candle cover for LHE14L globe holder, shown in black bronze. Hand finished in either polished brass (-PB), old brass (-OB), black bronze (-BB), antique bronze (-AB), antique nickel (-AN), satin nickel (-SN), bright nickel (-BN), bright chrome (-BC), or powder coated (-PC).

**Height:** 105mm. Ø 30mm.



**BTD70**

Italian brass drip imitation candle cover for LHE14S globe holder, shown in polished brass. Hand finished in either polished brass (-PB), old brass (-OB), black bronze (-BB), antique bronze (-AB), antique nickel (-AN), satin nickel (-SN), bright nickel (-BN), bright chrome (-BC), or powder coated (-PC).

**Height:** 70mm. Ø 30mm.



**BTP105**

Italian brass plain imitation candle cover for LHE14L globe holder, shown in bright chrome. Hand finished in either polished brass (-PB), old brass (-OB), black bronze (-BB), antique bronze (-AB), antique nickel (-AN), satin nickel (-SN), bright nickel (-BN), bright chrome (-BC), or powder coated (-PC).

**Height:** 105mm. Ø 30mm.



**BTP70**

Italian brass plain imitation candle cover for LHE14L globe holder, shown in satin nickel. Hand finished in either polished brass (-PB), old brass (-OB), black bronze (-BB), antique bronze (-AB), antique nickel (-AN), satin nickel (-SN), bright nickel (-BN), bright chrome (-BC), or powder coated (-PC).

**Height:** 70mm. Ø 30mm.



**LHE14S**

Black short 3 piece candle globe holder Small edison screw - E14 (SES). M10x1 integrated lock nut with earth. 250 Volt 2.0 Amp rated. 60 Watt maximum.  
**Height:** 70mm Ø 28mm



**LAGG7-W**

Italian opaque white imitation candle cover for LHE14S globe holder.  
**Height:** 70mm. Ø 30mm.



**LAGG7-C**

Italian opaque cream imitation candle cover for LHE14S globe holder.  
**Height:** 70mm. Ø 30mm.



**LAGG7-A**

Italian opaque antique imitation candle cover for LHE14S globe holder.  
**Height:** 70mm. Ø 30mm.

**BER58-0500**

Brass Extension rod 5/8" x 500mm threaded both ends 5mm x 26TPI with straight through coupling, shown in antique bronze. Hand finished in either polished brass (-PB), old brass (-OB), black bronze (-BB), antique bronze (-AB), antique nickel (-AN), satin nickel (-SN), bright nickel (-BN), bright chrome (-BC), or powder coated (-PC).

Also available in lengths of 750mm (BER58-0750), and 1000mm (BER58-1000).



**BER12-0500**

Brass Extension rod 1/2" x 500mm threaded both ends 5mm x 26TPI with straight through coupling, shown in polished brass. Hand finished in either polished brass (-PB), old brass (-OB), black bronze (-BB), antique bronze (-AB), antique nickel (-AN), satin nickel (-SN), bright nickel (-BN), bright chrome (-BC), or powder coated (-PC).

Also available in lengths of 750mm (BER12-0750), and 1000mm (BER12-1000).



**BER34-0500**

Brass Extension rod 3/4" x 500mm threaded both ends 5mm x 26TPI with straight through coupling, shown in antique nickel. Hand finished in either polished brass (-PB), old brass (-OB), black bronze (-BB), antique bronze (-AB), antique nickel (-AN), satin nickel (-SN), bright nickel (-BN), bright chrome (-BC), or powder coated (-PC).

Also available in lengths of 750mm (BER34-0750), and 1000mm (BER34-1000).



**BER38-0500**

Brass Extension rod 3/8" x 500mm threaded both ends 5mm x 26TPI with straight through coupling, shown in satin nickel. Hand finished in either polished brass (-PB), old brass (-OB), black bronze (-BB), antique bronze (-AB), antique nickel (-AN), satin nickel (-SN), bright nickel (-BN), bright chrome (-BC), or powder coated (-PC).

Also available in lengths of 750mm (BER38-0750), and 1000mm (BER38-1000).



**ROV-C6-11**

Light duty rectangular link nickel coloured steel chain, 1000mm lengths.



**ROV-C6-33**

Light duty rectangular link brass coloured steel chain, 1000mm lengths.



**ROV-C6-43**

Light duty rectangular link bronze coloured steel chain, 1000mm lengths.



**ROV-C9-11**

Regular duty oval link nickel coloured steel chain, 1000mm lengths.



**ROV-C9-33**

Regular duty oval link brass coloured steel chain, 1000mm lengths.



**ROV-C9-43**

Regular duty oval link bronze coloured steel chain, 1000mm lengths.



**ROV-C8-11**

Heavy duty rectangular link nickel coloured steel chain, 1000mm lengths.



**ROV-C8-33**

Heavy duty rectangular link brass coloured steel chain, 1000mm lengths.



**ROV-C8-43**

Heavy duty rectangular link bronze coloured steel chain, 1000mm lengths.



**GH-C7-04**

Heavy duty 4mm rectangular link raw brass chain, 475mm lengths.



**GH-C7-05**

Heavy duty 5mm rectangular link raw brass chain, 475mm lengths.



**GH-C3**

Regular duty oval link decorative raw brass chain, 475mm lengths.

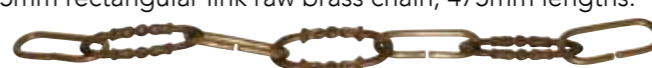

**GH-C5**

Heavy duty rectangular link decorative raw brass chain.





**VP3**

Brass adapter for B22 (BC) globe holder to 45mm shade. Hand finished in either polished brass (-PB), old brass (-OB), black bronze (-BB), antique bronze (-AB), antique nickel (-AN), or bright chrome (-BC). Also shown VP3D (Deeper for thick glass shades).



**G2F**

Pressed brass 2.25" (57mm) open gallery with 30mm entry for a B22 (BC) globe holder. Hand finished in either polished brass (-PB), old brass (-OB), black bronze (-BB), antique bronze (-AB), antique nickel (-AN), or bright chrome (-BC).



**G3GS**

Cast brass 3.25" (83mm) gallery with 10mm entry for intergrating into a fitting. Hand finished in either polished brass (-PB), old brass (-OB), black bronze (-BB), antique bronze (-AB), antique nickel (-AN), or bright chrome (-BC). Available in 4.25", 3.25" and 2.25" sizes (G4GS), (G3GS) and (G2GS) respectively.



**G4G**

Cast brass 4.25" (108mm) gallery with 30mm entry for a B22 (BC) globe holder. Hand finished in either polished brass (-PB), old brass (-OB), black bronze (-BB), antique bronze (-AB), antique nickel (-AN), or bright chrome (-BC).



**G5S**

Pressed brass 5.25" (133mm) gallery with 10mm entry for intergrating into a fitting. Hand finished in either polished brass (-PB), old brass (-OB), black bronze (-BB), antique bronze (-AB), antique nickel (-AN), or bright chrome (-BC). Available in 4.25" and 3.25" sizes (G4S) and (G3S) respectively.



**G6DS**

Spun brass 6.25" (159mm) gallery with 10mm entry for intergrating into a fitting. Hand finished in either polished brass (-PB), old brass (-OB), black bronze (-BB), antique bronze (-AB), antique nickel (-AN), or bright chrome (-BC). Available in 4.25", 3.25" and 2.25" sizes each with three screws instead of four. (G4DS), (G3DS) and (G2DS) respectively.



**G8**

Pressed brass 8.25" (210mm) gallery with 30mm entry for a B22 (BC) globe holder. Hand finished in either polished brass (-PB), old brass (-OB), black bronze (-BB), antique bronze (-AB), antique nickel (-AN), or bright chrome (-BC). Available in 6.25", 5.25", 4.25", 3.25" and 2.25" sizes each with three screws instead of four. (G6), (G5), (G4), (G3) and (G2) respectively.

**CPD145**

Pressed ceiling plate with cast decorative column and sconce cup and globe holder shown in old brass. Hand finished in either polished brass (-PB), old brass (-OB), black bronze (-BB), antique bronze (-AB), antique nickel (-AN), or bright chrome (-BC).



**CPD102**

Cast ceiling plate with cast decorative column and sconce cup and globe holder shown in black bronze. Hand finished in either polished brass (-PB), old brass (-OB), black bronze (-BB), antique bronze (-AB), antique nickel (-AN), or bright chrome (-BC).



**CG130**

Cast Gimbal brass 130mm height with 30mm entry for a B22 (BC) globe holder. 2.25" (57mm) top shade support. Hand finished in either polished brass (-PB), old brass (-OB), black bronze (-BB), antique bronze (-AB), antique nickel (-AN), or bright chrome (-BC).



**ABG130**

Brass Gimbal 130mm height with 30mm entry for a B22 (BC) globe holder. 2.25" (57mm) top shade support. Hand finished in either polished brass (-PB), old brass (-OB), black bronze (-BB), antique bronze (-AB), antique nickel (-AN), or bright chrome (-BC).



**ROV N60**

60mm zinc plated steel all threaded tube M10x1mm. Available in lengths of 10mm, 15mm, 20mm, 25mm, 30mm, 40mm, 45mm, 50mm, 60mm, 70mm, 80mm, 90mm, 100mm, 125mm, 150mm, 300mm & 1000mm.



**SF8**

Cast brass decorative 8.25" (210mm) spider with 30mm entry for a B22 (BC) globe holder. Hand finished in either polished brass (-PB), old brass (-OB), black bronze (-BB), antique bronze (-AB), antique nickel (-AN), or bright chrome (-BC).



**ET3**

Earth tag with 10mm hole for earthing multiple globe holder metal pendants or fittings with a non-metal globe holder.



**MISCL-CUP-HOOK**

Steel hook for ceiling mounting hanging fittings which are fitted with a Suspension hook.



**ROV LN9**

Zinc plated steel M10x1mm lock nut 13mm hexagonal.



**CPOLH**

100mm ceiling plate offset swivel and B22 (BC) globe holder attached to a 120mm stained woodblock. Hand finished in polished brass (-PB), old brass (-OB), black bronze (-BB), antique bronze (-AB), antique nickel (-AN), or bright chrome (-BC).



**CPHD**

Deep ceiling plate and hook mounted on a 85mm stained woodblock. Hand finished in either polished brass (-PB), old brass (-OB), black bronze (-BB), antique bronze (-AB), antique nickel (-AN), or bright chrome (-BC).



**CP**

100mm ceiling plate with 30mm hole to cover a batten fix B22 (BC) globe holder. Hand finished in either polished brass (-PB), old brass (-OB), black bronze (-BB), antique bronze (-AB), antique nickel (-AN), or bright chrome (-BC).



**CPLH3**

75mm ceiling plate, sconce cup and B22 (BC) globe holder. Hand finished in either polished brass (-PB), old brass (-OB), black bronze (-BB), antique bronze (-AB), antique nickel (-AN), or bright chrome (-BC).



**CPLH4**

100mm ceiling plate, sconce cup and B22 (BC) globe holder. Hand finished in either polished brass (-PB), old brass (-OB), black bronze (-BB), antique bronze (-AB), antique nickel (-AN), or bright chrome (-BC).



**CPH**

100mm ceiling plate and hook mounted on a 120mm stained woodblock. Hand finished in either polished brass (-PB), old brass (-OB), black bronze (-BB), antique bronze (-AB), antique nickel (-AN), or bright chrome (-BC).



**WB1**

85mm stained woodblock



**WB50**

120mm stained woodblock with 50mm hole.



**CPO**

100mm ceiling plate offset swivel mounted on a 120mm stained woodblock. Hand finished in either polished brass (-PB), old brass (-OB), black bronze (-BB), antique bronze (-AB), antique nickel (-AN), or bright chrome (-BC).



**CPOLH3C**

75mm diecast decorative ceiling plate, offset swivel sconce cup and B22 (BC) globe holder. Hand finished in either polished brass (-PB), old brass (-OB), black bronze (-BB), antique bronze (-AB), antique nickel (-AN), or bright chrome (-BC).



**CA44-34**

100mm spun brass ceiling canopy with 19.050mm hole. Hand finished in either polished brass (-PB), old brass (-OB), black bronze (-BB), antique bronze (-AB), antique nickel (-AN), or bright chrome (-BC). Available in 3/4" (CA44-34) Available in 5/8" (CA44-58) Available in 1/2" (CA44-12) Available in 3/8" (CA44-10)



**CA45-10**

100mm brass ceiling canopy with 10mm hole, shown in black bronze. Hand finished in either polished brass (-PB), old brass (-OB), black bronze (-BB), antique bronze (-AB), antique nickel (-AN), or bright chrome (-BC). Available in 1/2" (CA45-12)

**CA44-10SG**

100mm ceiling canopy with 10mm hole, 90mm x 10mm stem and brass cord grip. Hand finished in either polished brass (-PB), old brass (-OB), black bronze (-BB), antique bronze (-AB), antique nickel (-AN), or bright chrome (-BC).



**CA72-10**

60mm brass ceiling canopy with 10mm hole, shown in polished brass. Hand finished in either polished brass (-PB), old brass (-OB), black bronze (-BB), antique bronze (-AB), antique nickel (-AN), or bright chrome (-BC). Available in 1/2" (CA72-12)



**CA44-10SH**

100mm ceiling canopy with 10mm hole, 90mm x 10mm stem and brass hook. Hand finished in either polished brass (-PB), old brass (-OB), black bronze (-BB), antique bronze (-AB), antique nickel (-AN), or bright chrome (-BC).



**CA19-10**

90mm brass ceiling canopy with 10mm hole, shown in polished brass. Hand finished in either polished brass (-PB), old brass (-OB), black bronze (-BB), antique bronze (-AB), antique nickel (-AN), or bright chrome (-BC).



**CA44-10SL**

100mm ceiling canopy with 10mm hole, 90mm x 10mm stem and brass loop. Hand finished in either polished brass (-PB), old brass (-OB), black bronze (-BB), antique bronze (-AB), antique nickel (-AN), or bright chrome (-BC). Available in 3/4" (CA44-34SL)



**CA15-10**

90mm brass ceiling canopy with 10mm hole, shown in old brass. Hand finished in either polished brass (-PB), old brass (-OB), black bronze (-BB), antique bronze (-AB), antique nickel (-AN), or bright chrome (-BC).





**FF200-BG**

Brass flush fitting with glass ring and finial, shown in powder coated satin black. Hand finished in either polished brass (-PB), old brass (-OB), black bronze (-BB), antique bronze (-AB), antique nickel (-AN), or bright chrome (-BC).



**FF-GOUGER-12**

Gouger flush fitting 2xB22 (BC) shown in polished brass with an S4495 shade. Also available in a one light, smaller size FF-GOUGER-10.



**FF4-G**

Gold batten fix cover 4.25" (108mm) gallery with 30mm entry for a B22 (BC) globe holder.



**FF3-G**

Gold batten fix cover 3.25" (83mm) gallery with 30mm entry for a B22 (BC) globe holder.



**CP3001**  
B22 BC ornate cast head with a solid offset swivel and cast decorative back plate. Shown in black bronze. Hand finished in either polished brass (-PB), old brass (-OB), black bronze (-BB), antique bronze (-AB), antique nickel (-AN), or bright chrome (-BC).

**FF4-S**

Silver batten fix cover 4.25" (108mm) gallery with 30mm entry for a B22 (BC) globe holder.



**FF3-S**

Silver batten fix cover 3.25" (83mm) gallery with 30mm entry for a B22 (BC) globe holder. Shown with **S211** glass shade.



**CP6**  
B22 BC batten fix 80mm ceiling plate deep globe holder cover shown in antique bronze with a **VIN-ST64-60-B22**. Hand finished in either polished brass (-PB), old brass (-OB), black bronze (-BB), antique bronze (-AB), antique nickel (-AN), or bright chrome (-BC).

**FF4-W**

White batten fix cover 4.25" (108mm) gallery with 30mm entry for a B22 (BC) globe holder. Shown with **S2250** glass shade.



**FF3-W**

White batten fix cover 3.25" (83mm) gallery with 30mm entry for a B22 (BC) globe holder.



12Volt B22 BC batten fix 80mm ceiling plate deep globe holder cover shown in antique bronze. Hand finished in either polished brass (-PB), old brass (-OB), black bronze (-BB), antique bronze (-AB), antique nickel (-AN), or bright chrome (-BC).

**CPZ183**



**CPZ130**

12 Volt B22 BC batten fix 80mm ceiling plate deep globe holder cover shown in antique bronze. Hand finished in either polished brass (-PB), old brass (-OB), black bronze (-BB), antique bronze (-AB), antique nickel (-AN), or bright chrome (-BC).



# Ceiling - Suspensions

Many houses today are not seeing wide offerings of choice when it comes to lighting, especially over kitchen benches and main living spaces, lacking the character to reflect the home and the people living in it.

Hanging suspension lights are a fantastic way to liven up your home, adding colour, style and more light to brighten up your home. Our extensive range of suspensions is continuously growing, featuring glass shades, metal shades and shadeless cord suspensions. It is clear that hanging suspensions are a great addition to create a more illuminated and comfortable home.

Suspended lights are a delight to use in any setting and add a new dimension to your home lighting needs. These lights look and feel good, and add a large dose of class and style to the surroundings. There is a range of styles and purposes for suspension lights and there is no better place to look than Robert Kitto. We offer a wide range of the best products, meticulously constructed with well thought-out designs.

Take a look at our basic models in the Brass Cord Suspension (BCS) and Brass Rod Suspension (BRS) series of suspension lights. These are simply constructed and sport an easygoing, minimalist look, providing great illumination for rooms that require some extra lighting. The BC models are available with your choice of metal finish, and the BR models feature decorative chain adornments giving them a classy and regal look. If you are looking for fashionable working lights for your kitchen or work area, consider our Tom Dixon replica models, which are specially made using design influences from Indian cookware for an additional hint of style. The copper fittings and the matt black finish give these a modern and contemporary look. Need a more retro or rustic ambience and want a little extra old school class? Take a look at our special range of iron rust hanging lights. Specially finished by hand so that no two units are the same, these sport the old-world charm and feel to elevate your interiors to the next level. When looking for suspension lights, shop at Robert Kitto, and you can be guaranteed of complete satisfaction.



PD10S  
Ceiling Suspensions  
Finished in Antique Bronze  
with S1029 shades.

On display at 'The Springfield 242'  
Rosdale Homes Virginia Display Village.

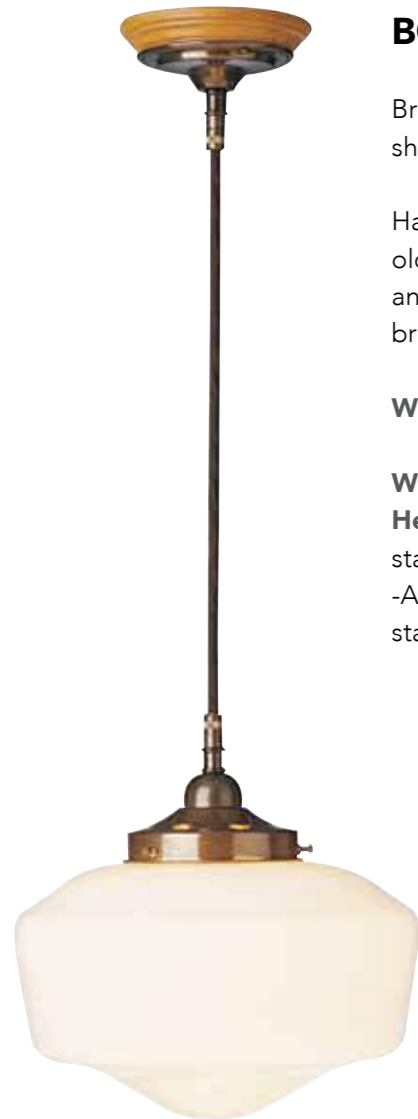

### BCS3

Brass cord Suspension with an integrated G2D gallery shown in polished brass with an **SGC12-OG** glass shade.

Hand finished in either polished brass (-PB), old brass (-OB), black bronze (-BB), antique bronze (-AB), antique nickel (-AN), bright chrome (-BC) or powder coated (-PC).

**Wiring:** 1x B22 (BC), 60 watt maximum globe holder(s).

**Width:** 120mm **Depth:** 120mm

**Height:** 100mm + **Suspension:** 1000mm brown cotton standard.

-AN, -BC and -PC finishes have black cotton cable as standard.

### BCS1

Brass cord Suspension shown in black bronze with a **G4** black bronze gallery and an **S2250** shade.

Hand finished in either polished brass (-PB), old brass (-OB), black bronze (-BB), antique bronze (-AB), antique nickel (-AN), bright chrome (-BC) or powder coated (-PC).

**Wiring:** 1x B22 (BC), 60 watt maximum globe holder(s).

**Width:** 120mm **Depth:** 120mm

**Height:** 100mm +

**Suspension:** 1000mm brown cotton standard.

-AN, -BC and -PC finishes have black cotton cable as standard.

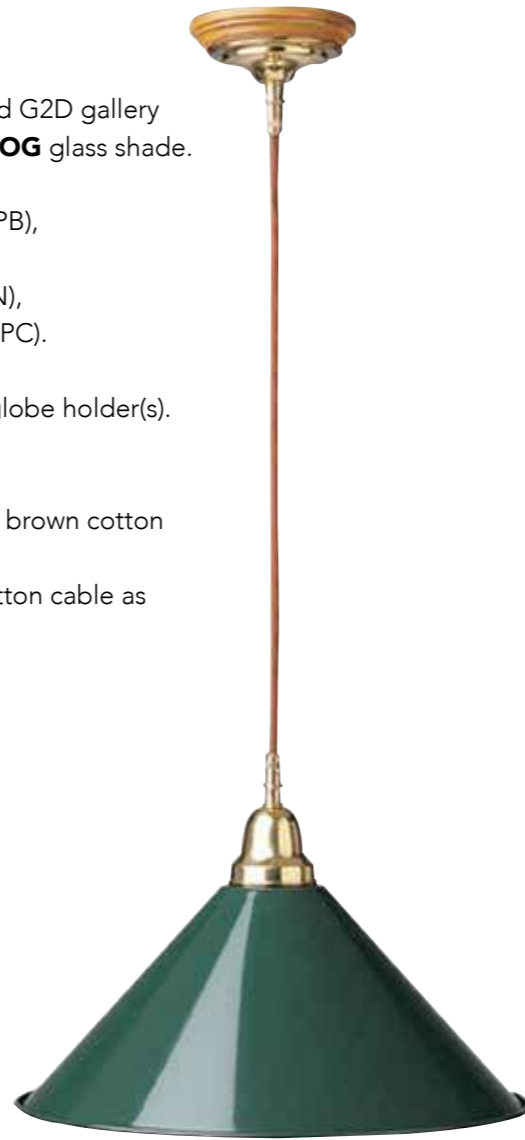
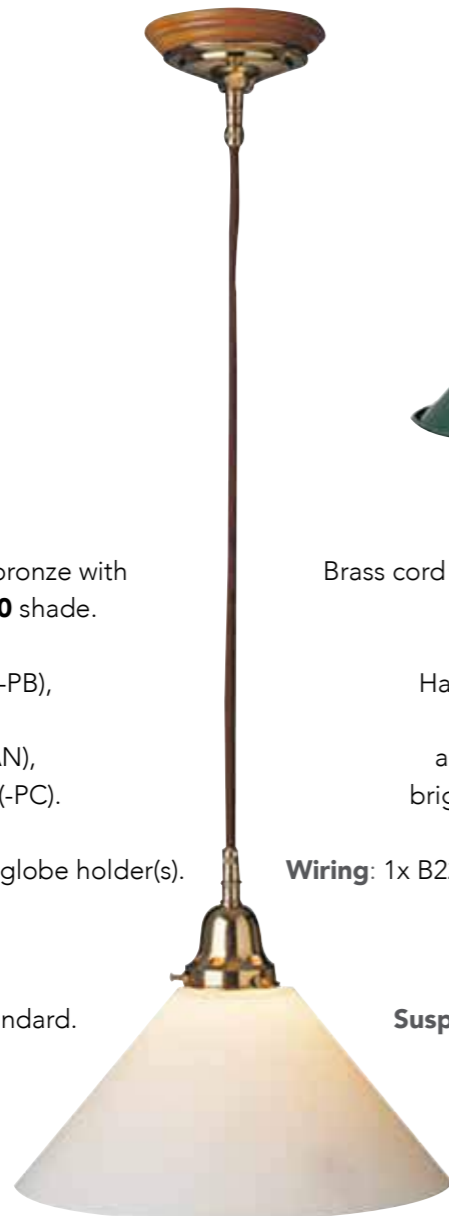

### BCS4

Brass cord Suspension shown in polished brass with an **SMC14-PC** Green shade.

Hand finished in either polished brass (-PB), old brass (-OB), black bronze (-BB), antique bronze (-AB), antique nickel (-AN), bright chrome (-BC) or powder coated (-PC).

**Wiring:** 1x B22 (BC), 60 watt maximum globe holder(s).

**Width:** 120mm **Depth:** 120mm

**Height:** 100mm +

**Suspension:** 1000mm brown cotton standard.

-AN, -BC and -PC finishes have black cotton cable as standard.

### BCS5

Brass cord Suspension shown in satin nickel with an **S2188** shade.

**Wiring:** 1x B22 (BC), 60 watt maximum globe holder(s).

**Width:** 80mm **Depth:** 80mm

**Height:** 80mm + **Suspension:** 1000mm brown cotton standard.

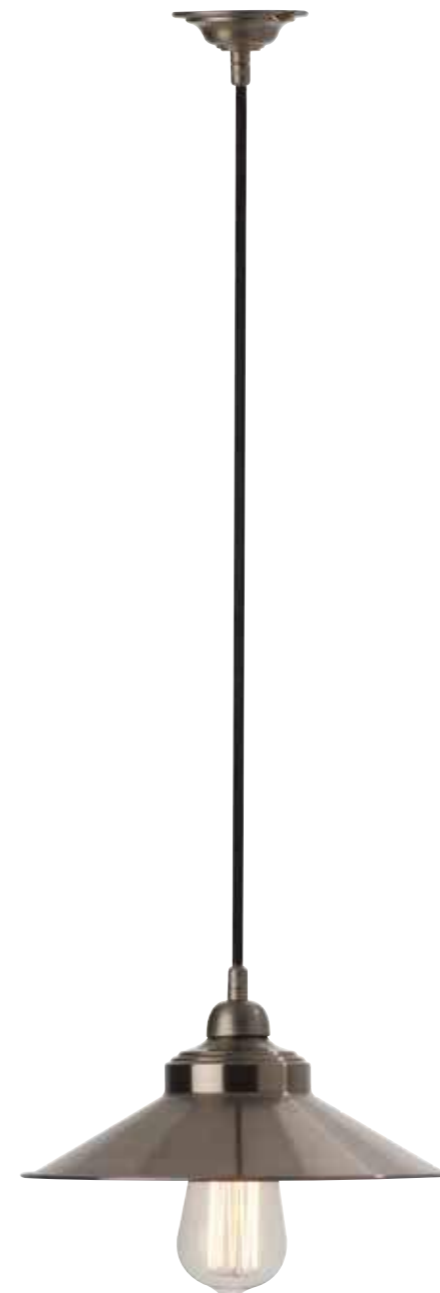

### BCS5

Brass cord Suspension shown in iron rust with an **SML14-IR** shade.

Hand finished in either polished brass (-PB), old brass (-OB), black bronze (-BB), antique bronze (-AB), antique nickel (-AN), bright chrome (-BC) powder coated (-PC), or iron rust (-IR).

**Wiring:** 1x B22 (BC), 60 watt maximum globe holder(s).

**Width:** 80mm **Depth:** 80mm

**Height:** 80mm + **Suspension:** 1000mm brown cotton standard.

-AN, -BC and -PC finishes have black cotton cable as standard.

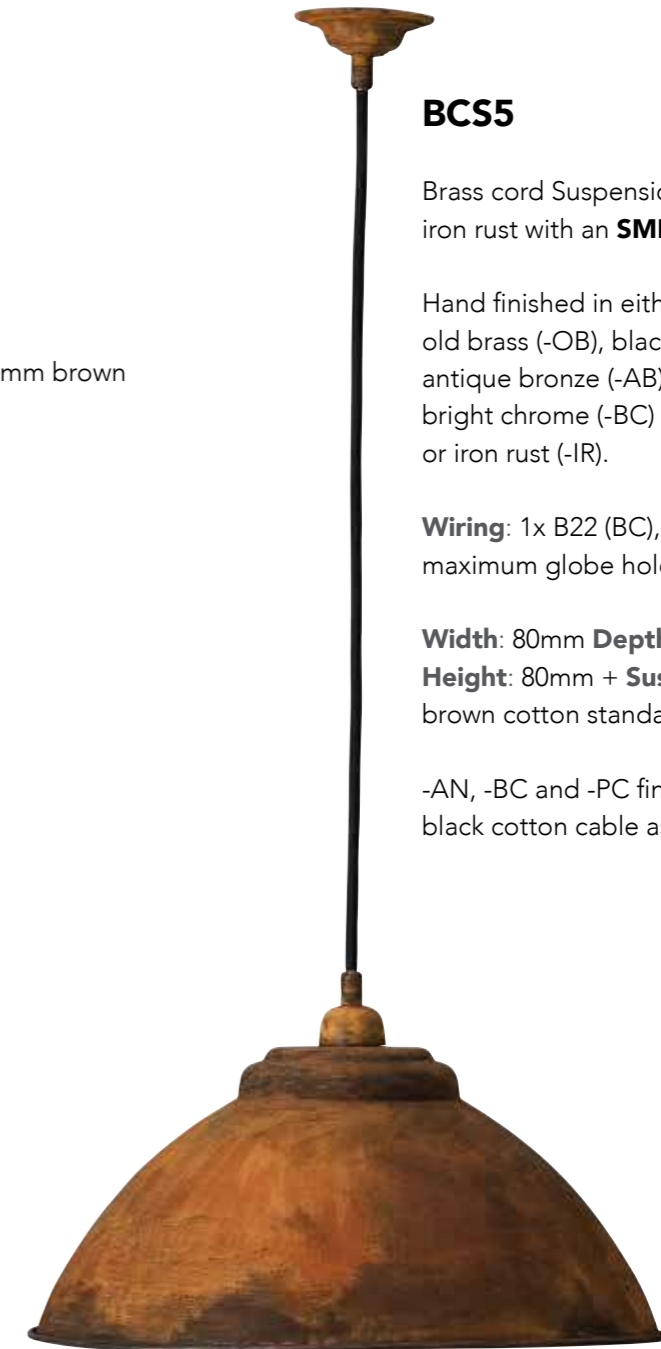

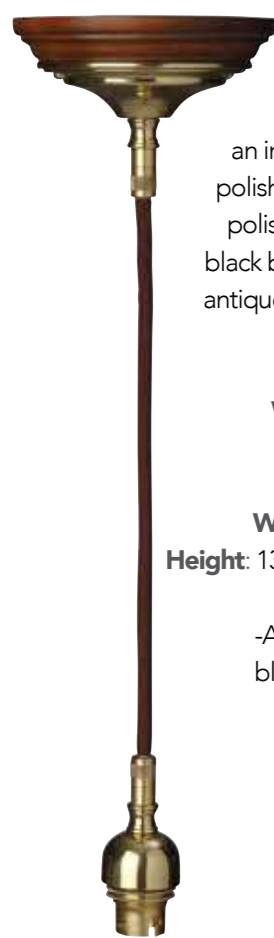
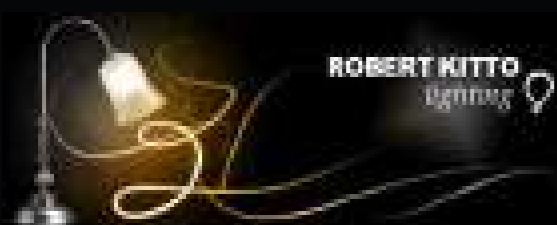

**BCS3**

Brass cord suspension with an integrated G2D gallery shown in polished brass. Hand finished in either polished brass (-PB), old brass (-OB), black bronze (-BB), antique bronze (-AB), antique nickel (-AN), bright chrome (-BC) or powder coated (-PC).

**Wiring:** 1x B22 (BC), 60 watt maximum globe holder(s).

**Width:** 120mm **Depth:** 120mm  
**Height:** 130mm + **Suspension:** 1000mm brown cotton standard.  
-AN, -BC and -PC finishes have black cotton cable as standard.



**BCS1**

Brass cord suspension shown in polished brass. Hand finished in either polished brass (-PB), old brass (-OB), black bronze (-BB), antique bronze (-AB), antique nickel (-AN), bright chrome (-BC) or powder coated (-PC).

**Wiring:** 1x B22 (BC), 60 watt maximum globe holder(s).

**Width:** 120mm **Depth:** 120mm  
**Height:** 100mm + **Suspension:** 1000mm brown cotton standard.

-AN, -BC and -PC finishes have black cotton cable as standard.

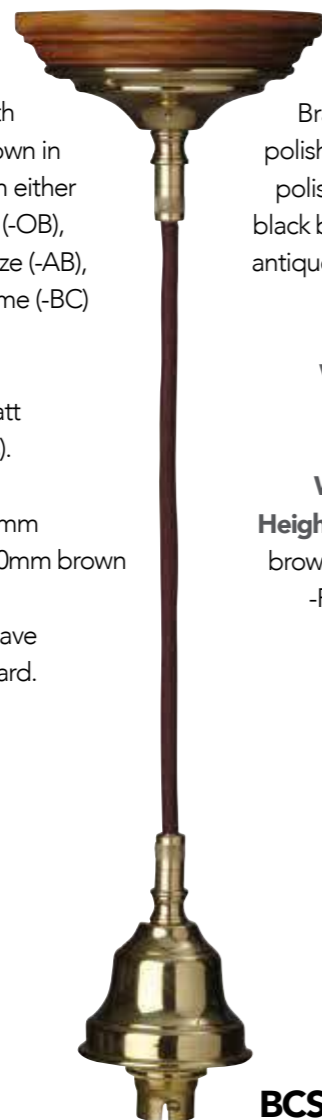

**BCS5**

Brass cord suspension shown in polished brass. Hand finished in either polished brass (-PB), old brass (-OB), black bronze (-BB), antique bronze (-AB), antique nickel (-AN), bright chrome (-BC) or powder coated (-PC).

**Wiring:** 1x B22 (BC), 60 watt maximum globe holder(s).

**Width:** 80mm **Depth:** 80mm  
**Height:** 80mm + **Suspension:** 1000mm brown cotton standard. -AN, -BC and -PC finishes have black cotton cable as standard.

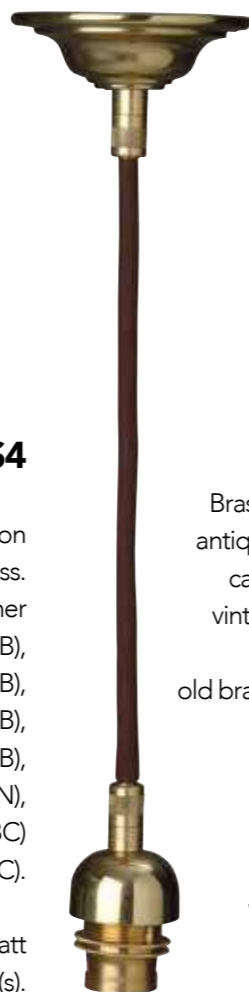

**BCS4**

Brass cord suspension shown in polished brass. Hand finished in either polished brass (-PB), old brass (-OB), black bronze (-BB), antique bronze (-AB), antique nickel (-AN), bright chrome (-BC) or powder coated (-PC).

**Wiring:** 1x B22 (BC), 60 watt maximum globe holder(s).

**Width:** 120mm **Depth:** 120mm  
**Height:** 130mm + **Suspension:** 1000mm brown cotton standard.  
-AN, -BC and -PC finishes have black cotton cable as standard.



**BCS6**

Brass cord suspension shown in antique bronze with Black cotton cable and a **VIN-G95-60-B22** vintage globe. Hand finished in either polished brass (-PB), old brass (-OB), black bronze (-BB), antique bronze (-AB), antique nickel (-AN), bright chrome (-BC), or powder coated (-PC).

**Wiring:** 1x B22 (BC), 60 watt maximum globe holder(s).

**Width:** 80mm **Depth:** 80mm  
**Height:** 90mm + **Suspension:** 1000mm brown cotton standard.

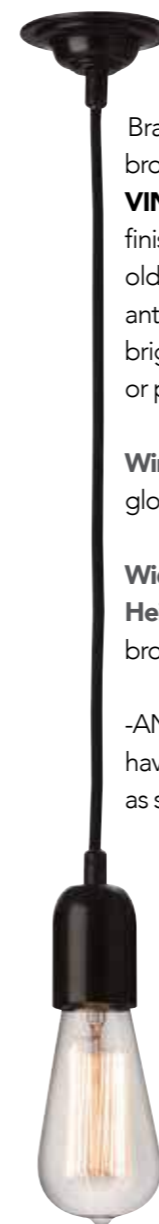

**BCS6**

Brass cord suspension shown in antique bronze with black cable and a **VIN-ST64-60-B22** vintage globe. Hand finished in either polished brass (-PB), old brass (-OB), black bronze (-BB), antique bronze (-AB), antique nickel (-AN), bright chrome (-BC), or powder coated (-PC).

**Wiring:** 1x B22 (BC), 60 watt maximum globe holder(s).

**Width:** 80mm **Depth:** 80mm  
**Height:** 80mm + **Suspension:** 1000mm brown cotton standard.

-AN, -BC and -PC finishes have black cotton cable as standard.



**BCS6**

Also shown in antique nickel with red cable and a **VIN-G125-60-B22** vintage globe.

**BCS7**

Brass cord suspension shown in antique bronze. Hand finished in either polished brass (-PB), old brass (-OB), black bronze (-BB), antique bronze (-AB), antique nickel (-AN), bright chrome (-BC), or powder coated (-PC).

**Wiring:** 1x B22 (BC), 60 watt maximum globe holder(s).

**Width:** 80mm **Depth:** 80mm  
**Height:** 120mm + **Suspension:** 1000mm brown cotton standard.



**BCS8**

Brass cord suspension shown in old brass. Hand finished in either polished brass (-PB), old brass (-OB), black bronze (-BB), antique bronze (-AB), antique nickel (-AN), bright chrome (-BC), or powder coated (-PC).

**Wiring:** 1x B22 (BC), 60 watt maximum globe holder(s).

**Width:** 275mm **Depth:** 80mm  
**Height:** 310mm + **Suspension:** 1000mm brown cotton standard.



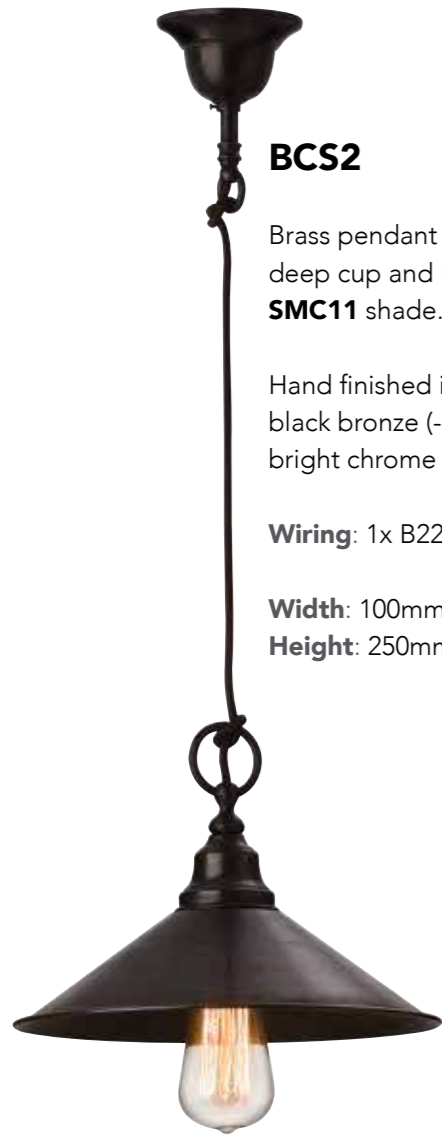

### BCS2

Brass pendant suspension with black cotton flex, an integrated deep cup and loop shown in antique bronze with an antique bronze **SMC11** shade.

Hand finished in either polished brass (-PB), old brass (-OB), black bronze (-BB), antique bronze (-AB), antique nickel (-AN), bright chrome (-BC) or powder coated (-PC).

**Wiring:** 1x B22 (BC), 60 watt maximum globe holder(s).

**Width:** 100mm **Depth:** 100mm

**Height:** 250mm + **Suspension:** 1000mm Cotton cable

### BCS2-G2GS-ELH

Brass pendant suspension with black cotton flex, an integrated G2GS cast gallery and an extended lamp holder shown in antique nickel with an **S1029** shade.

Hand finished in either polished brass (-PB), old brass (-OB), black bronze (-BB), antique bronze (-AB), antique nickel (-AN), bright chrome (-BC) or powder coated (-PC).

**Wiring:** 1x B22 (BC), 60 watt maximum globe holder(s).

**Width:** 100mm **Depth:** 100mm

**Height:** 300mm + **Suspension:** 1000mm Cotton cable

-PB, -OB, -BB, -AB finishes come with brown cotton flex. Other colours optional.

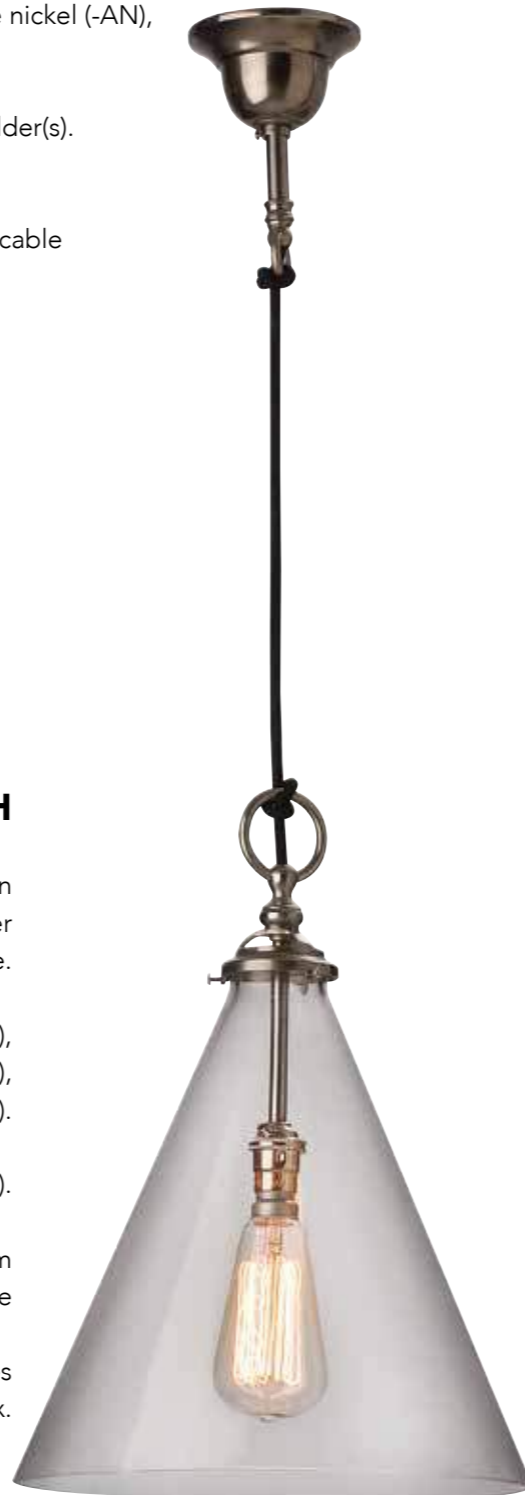

### BCS2TS

Brass pendant suspension with black twisted Italian silk flex, an integrated deep cup and loop shown in antique bronze with an **SML14-AB** shade. Hand finished in either old brass (-OB), antique bronze (-AB), satin nickel (-SN), or powder coated (-PC).

**Wiring:** 1x B22 (BC), 60 watt maximum globe holder(s). **Width:** 100mm **Depth:** 100mm

**Height:** 250mm + **Suspension:** 1000mm Cotton cable



### BCS2TS

Brass pendant suspension with black twisted Italian silk flex, an integrated deep cup and loop shown in satin nickel with an **SML18-SN** shade. Hand finished in either old brass (-OB), antique bronze (-AB), satin nickel (-SN), or powder coated (-PC).

**Wiring:** 1x B22 (BC), 60 watt maximum globe holder(s).

**Width:** 100mm **Depth:** 100mm

**Height:** 250mm + **Suspension:** 1000mm Cotton cable

### BRS1275-G2GS

Brass rod suspension with an integrated G2GS cast gallery, shown in antique nickel with an **S1801-OG** glass shade. Hand finished in either polished brass (-PB), old brass (-OB), black bronze (-BB), antique bronze (-AB), antique nickel (-AN), or bright chrome (-BC).

**Wiring:** 1x B22 (BC), 60 watt maximum globe holder(s).

**Weight:** 0.7Kg. **Width:** 100mm **Depth:** 100mm  
**Height:** 60mm + **Suspension:** 12.700mm x 750mm



### BRS1275-G2GS

Brass rod suspension with integrated G2GS cast gallery shown in old brass with an **S1017-OG** shade. Hand finished in either polished brass (-PB), old brass (-OB), black bronze (-BB), antique bronze (-AB), antique nickel (-AN), bright chrome (-BC), or powder coated (-PC).

**Wiring:** 1x B22 (BC), 60 watt maximum globe holder(s).

**Width:** 100mm **Depth:** 100mm  
**Height:** 150mm + **Suspension:** 12.700mm x 750mm.

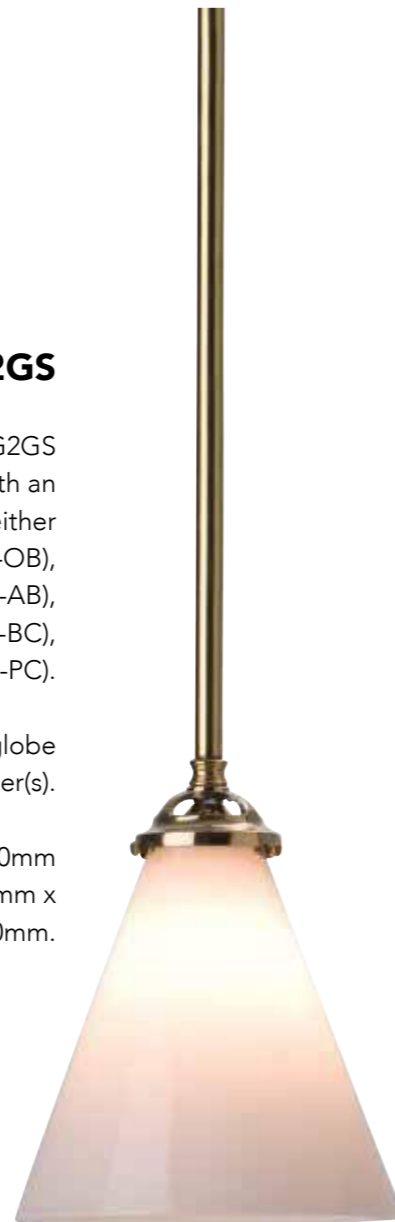

### BRS5875-G3DS-ELH

Brass rod suspension with integrated extended lamp holder and G3DS gallery. Shown in antique nickel with an **S1044** shade. Hand finished in either polished brass (-PB), old brass (-OB), black bronze (-BB), antique bronze (-AB), antique nickel (-AN), bright chrome (-BC) or powder coated (-PC).

**Wiring:** 1x B22 (BC), 60 watt maximum globe holder(s).

**Width:** 100mm **Depth:** 100mm  
**Height:** 375mm + **Suspension:** 15.875mm x 750mm



### BRS1275-G2GS-ELH

Brass rod suspension with integrated G2GS cast gallery and extended lamp holder shown in antique nickel with an **S1030** shade.

Hand finished in either polished brass (-PB), old brass (-OB), black bronze (-BB), antique bronze (-AB), antique nickel (-AN), bright chrome (-BC), or powder coated (-PC).

**Wiring:** 1x B22 (BC), 60 watt maximum globe holder(s).

**Width:** 100mm **Depth:** 100mm  
**Height:** 300mm + **Suspension:** 12.700mm x 750mm



### BRS1275CDSC-E27

Brass rod suspension with a decorative spindle and cup, shown in bright chrome with an **S1121** glass shade. Hand finished in either polished brass (-PB), old brass (-OB), black bronze (-BB), antique bronze (-AB), antique nickel (-AN), or bright chrome (-BC).

**Wiring:** 1x E27 (ES), 60 watt maximum globe holder(s).

**Weight:** 0.9Kg. **Width:** 100mm **Depth:** 100mm  
**Height:** 230mm + **Suspension:** 12.700mm x 750mm

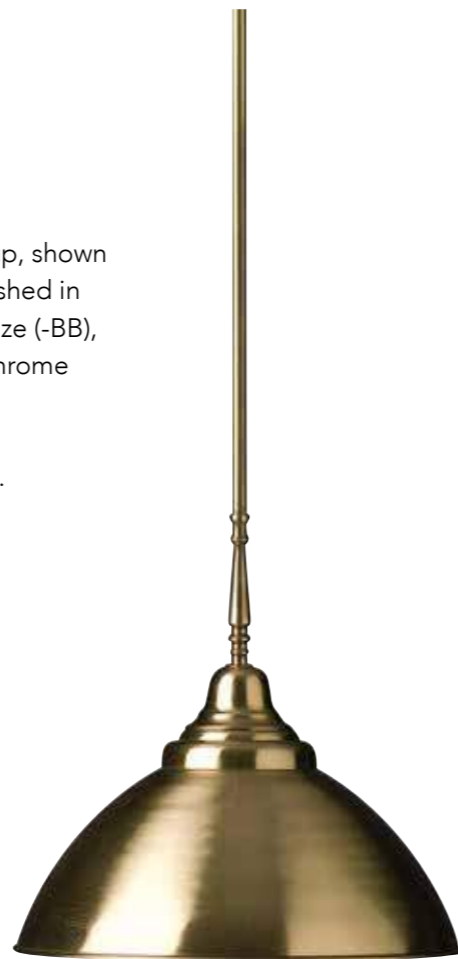
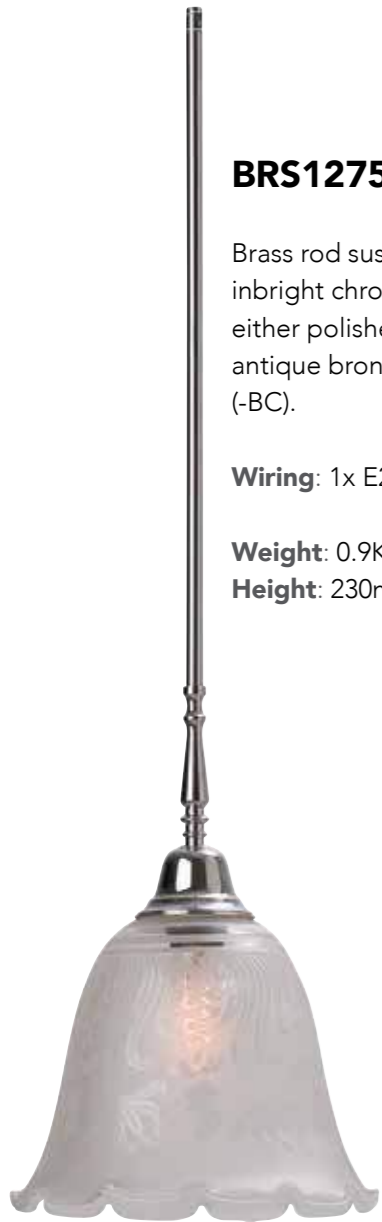

### BRS1275CDSC-B22

Brass rod suspension with decorative cast spindle and bell cup, shown in old brass with an **SML14-OB** shade. Hand finished in either old brass (-OB), antique bronze (-AB), or satin nickel (-SN).

**Wiring:** 1x B22 (BC), 60 watt maximum globe holder(s).

**Weight:** 0.9Kg. **Width:** 100mm **Depth:** 100mm  
**Height:** 230mm + **Suspension:** 12.700 x 750mm

### BRS1275CDSC-E27

Brass rod suspension with a decorative spindle and cup, shown in antique nickel with an **S1279** glass shade. Hand finished in either polished brass (-PB), old brass (-OB), black bronze (-BB), antique bronze (-AB), antique nickel (-AN), or bright chrome (-BC).

**Wiring:** 1x E27 (ES), 60 watt maximum globe holder(s).

**Weight:** 0.9Kg. **Width:** 100mm **Depth:** 100mm  
**Height:** 230mm + **Suspension:** 12.700mm x 750mm



### BRS1275CDS-G4DS

Brass rod suspension with decorative cast spindle and integrated **G4DS** gallery, shown in antique nickel with an **S1550** glass shade. Hand finished in either polished brass (-PB), old brass (-OB), black bronze (-BB), antique bronze (-AB), antique nickel (-AN), bright chrome (-BC), or powder coated (-PC).

**Wiring:** 1x B22 (BC), 60 watt maximum globe holder(s).

**Weight:** 0.9Kg. **Width:** 100mm **Depth:** 100mm  
**Height:** 245mm +  
**Suspension:** 12.700 x 750mm



### BRASS SUSPENSION RODS

Brass rod suspensions available in 3/8", 1/2", 5/8" and 3/4", in lengths of 500mm, 750mm and 1000mm. Available in all finishes; polished brass (-PB), old brass (-OB), black bronze (-BB), antique bronze (-AB), antique nickel (-AN), satin nickel (-SN), bright nickel (-BN), bright chrome (-BC) or powder coated (-PC).



### BRS125-SN

Brass rod suspension shown in satin nickel with an **S2188** shade.

**Wiring:** 1x B22 (BC), 60 watt maximum globe holder(s).

**Weight:** 0.4Kg. **Width:** 100mm **Depth:** 100mm  
**Height:** 50mm + **Suspension:** 12.700 x 500mm.

### CS3-G6DS-ELHC

Heavy duty brass chain set with an integrated G6DS deep gallery and an extended globe holder cluster. Shown in black bronze with an **SPH350-CLEAR** glass shade. Hand finished in either polished brass (-PB), black bronze (-BB), or bright chrome (-BC),

**Wiring:** 3x B15 (SBC), 40 watt maximum globe holder(s).

**Width:** 159mm **Depth:** 159mm

**Height:** 120mm + **Suspension:** C8 Chain x 1000mm.



### BCS2-G6DS

Brass cord suspension with integrated G6DS deep gallery. Shown in Bright Chrome with clear PVC cable and a **SPH350-CLEAR** glass shade. Hand finished in either polished brass (-PB), old brass (-OB), black bronze (-BB), antique bronze (-AB), antique nickel (-AN), bright chrome (-BC), or powder coated (-PC).

**Wiring:** 1x B22 (BC), 60 watt maximum globe holder(s).

**Width:** 159mm **Depth:** 159mm

**Height:** 120mm + **Suspension:** 1000mm.



### BRS5875-G6DS-BAF

Brass rod set 15.875mm (5/8") by 750mm plus a band and finial set to fit a 350mm sphere. Shown in black bronze with an **SPH350-OG** glass shade. Hand finished in either polished brass (-PB), old brass (-OB), black bronze (-BB), antique bronze (-AB), antique nickel (-AN), bright chrome (-BC), or powder coated (-PC).

**Wiring:** 1x B22 (BC), 60 watt maximum globe holder(s).

**Width:** 120mm **Depth:** 120mm

**Height:** 120mm + **Suspension:** 15.875mm x 750mm.

### BRS-MOSMAN

Brass rod set 15.875mm (5/8") by 750mm with a three globe holder cluster plus a band and finial set to suit to 2x **S1279** glass shades.

Shown in black bronze with 2x S1279 glass shades

Hand finished in either polished brass (-PB), old brass (-OB), black bronze (-BB), antique bronze (-AB), antique nickel (-AN), bright chrome (-BC), or powder coated (-PC).

**Wiring:** 3x B22 (BC), 60 watt maximum globe holder(s).

**Weight:** 1.1Kg **Width:** 120mm **Depth:** 120mm

**Height:** 500mm + **Suspension:** 15.875mm x 500mm.







### CWS-G2DS

Counter weight suspension with gallery cup (G2DS) shown in two tone, polished brass and powder coated brunswick green gloss with a **SGC12-G** shade.

Hand finished in either polished brass (-PB), old brass (-OB), black bronze (-BB), antique bronze (-AB), antique nickel (-AN), bright chrome (-BC) or powder coated (-PC).

**Wiring:** 1x B22 (BC), 60 watt maximum globe holder(s).

**Depth:** 120mm

**Height:** 250mm + **Suspension:** 2500mm brown cotton standard, allows for variable height from one to two metres.

-AN, -BC and -PC finishes have black cotton cable as standard.

### CWS

Counter weight suspension shown in polished brass with a **SMC14-PC** indian red shade.

Hand finished in either polished brass (-PB), old brass (-OB), black bronze (-BB), antique bronze (-AB), antique nickel (-AN), bright chrome (-BC), or powder coated (-PC).

**Wiring:** 1x B22 (BC), 60 watt maximum globe holder(s).

**Depth:** 120mm

**Height:** 250mm + **Suspension:** 2500mm brown cotton standard allows for variable height from one to two metres.

-AN and -BC finishes have black cotton cable as standard.



### CWSGC

Counter weight suspension shown in antique bronze with an **SMC11** shade.

**Wiring:** 1x B22 (BC), 60 watt maximum globe holder(s).

**Depth:** 120mm

**Height:** 250mm + **Suspension:** 2500mm brown cotton standard, allows for variable height from one to two metres.



### CWSGC

Counter weight suspension shown in antique bronze with an **SML14-AB** shade. Hand finished in either old brass (-OB), antique bronze (-AB), or satin nickel (-SN).

**Wiring:** 1x B22 (BC), 60 watt maximum globe holder(s).

**Depth:** 120mm **Height:** 250mm + **Suspension:** 2500mm brown cotton standard, allows for variable height from one to two metres.

-SN finish has black cotton cable as standard.



### CWSCB-G2DS

Counter weight suspension with fluted die cast body and an integrated G2DS gallery shown in antique bronze with a **S191** shade. Hand finished in either polished brass (-PB), old brass (-OB), black bronze (-BB), antique bronze (-AB), antique nickel (-AN), or bright chrome (-BC). -AN and -BC finishes have black cotton cable as standard.

**Wiring:** 1x B22 (BC), 60 watt maximum globe holder(s).

**Width:** 195mm **Depth:** 120mm **Height:** 250mm + **Suspension:** 2500mm cotton standard, allows for variable total height from one to two metres.



### CWSCB-2G2FS

Twin counter weight suspension with fluted die cast body and two integrated G2FS galleries shown in antique bronze with 2x **S191** shades. Hand finished in either polished brass (-PB), old brass (-OB), black bronze (-BB), antique bronze (-AB), antique nickel (-AN), or bright chrome (-BC). -AN and -BC finishes have black cotton cable as standard.

**Wiring:** 2x B22 (BC), 60 watt maximum globe holder(s).

**Width:** 640mm **Depth:** 120mm **Height:** 250mm + **Suspension:** 2500mm cotton standard, allows for variable height from one to two metres.



### BRS-ST\_LEONARDS

St Leonards rise and fall chain suspension shown in polished brass with an **S6032-AF** glass.

Hand finished in either polished brass (-PB), old brass (-OB), black bronze (-BB), antique bronze (-AB), antique nickel (-AN), or bright chrome (-BC).

**Wiring:** 1x B22 (BC), 60 watt maximum globe holder(s).

**Depth:** 120mm **Height:** 700mm (including glass) + **Suspension:** 12.700 x 500mm.



### BRS-ST\_PETERS

St Peters rise and fall chain suspension shown in polished brass with an **S71191-AF** glass.

Hand finished in either polished brass (-PB), old brass (-OB), black bronze (-BB), antique bronze (-AB), antique nickel (-AN), or bright chrome (-BC).

**Wiring:** 1x B22 (BC), 60 watt maximum globe holder(s).

**Depth:** 120mm **Height:** 660mm (including glass) + **Suspension:** 12.700 x 500mm.

### PD300R-BGL

Brass rod suspension with decorative spindle and integrated G4S gallery, ring and finial encasing a large blown glass. Hand finished in either polished brass (-PB), old brass (-OB), black bronze (-BB), antique bronze (-AB), antique nickel (-AN), or bright chrome (-BC).

**Wiring:** 1x B22 (BC), 60 watt maximum globe holder(s).

**Width:** 240mm **Depth:** 240mm

**Height:** 380mm + **Suspension:** 12.700 x 750mm

Also available on chain PD300C-BGL.  
Also available with medium blown glass.  
(PD300R-BGM and PD300C-BGM).



### PD400C-BGM

Satin black powder coated aluminium chain suspension with integrated G4S gallery, ring and finial encasing a medium blown glass.

**Wiring:** 1x B22 (BC), 60 watt maximum globe holder(s).

**Width:** 240mm **Depth:** 240mm

**Height:** 280mm + **Suspension:** 1000m decorative C3 chain.

Also available on rod PD400R-BGM.  
Also available with Large blown glass.  
(PD400C-BGL and PD400R-BGL).



### BRS343SR

Cromwell brass rod suspension shown in polished brass with a **G4** polished brass gallery and an **S76424-OM** shade. Hand finished in either polished brass (-PB), old brass (-OB), black bronze (-BB), antique bronze (-AB), antique nickel (-AN), or bright chrome (-BC).

**Wiring:** 1x B22 (BC), 60 watt maximum globe holder(s).

**Width:** 210mm **Depth:** 210mm

**Height:** 500mm + **Suspension:** 19.050mm x 300mm



### BRS3SC

Blyth brass rod suspension shown in black bronze with a **G8** black bronze gallery and an **S4972-OM** shade.

Hand finished in either polished brass (-PB), old brass (-OB), black bronze (-BB), antique bronze (-AB), antique nickel (-AN), or bright chrome (-BC).

**Wiring:** 1x B22 (BC), 60 watt maximum globe holder(s).

**Width:** 210mm **Depth:** 210mm

**Height:** 500mm + **Suspension:** 12.700mm x 300mm





### SL1

Claremont surround light suspension shown in polished brass with a **G2** polished brass gallery and an **S3133** shade. Hand finished in either polished brass (-PB), old brass (-OB), black bronze (-BB), antique bronze (-AB), antique nickel (-AN), or bright chrome (-BC).

**Wiring:** 1x B22 (BC), 60 watt maximum globe holder(s).

**Width:** 315mm **Depth:** 100mm  
**Height:** 390mm + **Suspension:** 12.700mm x 750mm



### SL2-G2DS

Claremont surround light suspension with an integrated G2DS gallery shown in polished brass with an **S3138** shade. Hand finished in either polished brass (-PB), old brass (-OB), black bronze (-BB), antique bronze (-AB), antique nickel (-AN), or bright chrome (-BC).

**Wiring:** 1x B22 (BC), 60 watt maximum globe holder(s).

**Width:** 315mm **Depth:** 100mm  
**Height:** 390mm + **Suspension:** 12.700mm x 750mm

### BRS1275-G6DS

Brass rod suspension with integrated G6DS gallery shown in black bronze shown with an **S40** shade. Hand finished in either polished brass (-PB), old brass (-OB), black bronze (-BB), antique bronze (-AB), antique nickel (-AN), bright chrome (-BC) or powder coated (-PC).

**Wiring:** 1x B22 (BC), 60 watt maximum globe holder(s).

**Width:** 160mm **Depth:** 160mm  
**Height:** 180mm + **Suspension:** 12.700mm x 750mm



### BRS1275CDS

Cast rod spindle shown in polished brass with a **G2** polished brass gallery and an **SGC12-C** shade. Hand finished in either polished brass (-PB), old brass (-OB), black bronze (-BB), antique bronze (-AB), antique nickel (-AN), bright chrome (-BC) or powder coated (-PC).

**Wiring:** 1x B22 (BC), 60 watt maximum globe holder(s).

**Width:** 100mm **Depth:** 100mm  
**Height:** 125mm + **Suspension:** 12.700mm x 750mm

### BRS125S-G4GS

Brass decorated rod suspension with integrated G4GS gallery shown in polished brass with a **BER125** polished brass extension rod and joiner and an **S987** shade and **F7** finial. Hand finished in either polished brass (-PB), old brass (-OB), black bronze (-BB), antique bronze (-AB), antique nickel (-AN), bright chrome (-BC) or powder coated (-PC).

**Wiring:** 1x B22 (BC), 60 watt maximum globe holder(s).

**Width:** 100mm **Depth:** 100mm  
**Height:** 125mm +  
**Suspension:** 12.700mm x 750mm



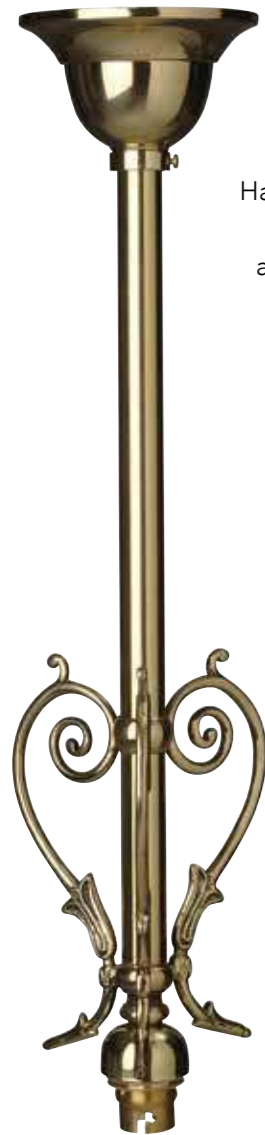

**BRS3475DS**

Brass rod suspension with three way decorative scroll shown in polished brass. Hand finished in either polished brass (-PB), old brass (-OB), black bronze (-BB), antique bronze (-AB), antique nickel (-AN), or bright chrome (-BC).

**Wiring:** 1x B22 (BC), 60 watt maximum globe holder(s).

**Suspension:** 19.050mm x 750mm

**BRS1275DS-3**

Brass rod suspension with three way decorative scroll shown in bright chrome. Hand finished in either polished brass (-PB), old brass (-OB), black bronze (-BB), antique bronze (-AB), antique nickel (-AN), or bright chrome (-BC).

**Wiring:** 1x B22 (BC), 60 watt maximum globe holder(s).

**Height:** 125mm +  
**Suspension:** 12.700mm x 750mm



**BRS1275DS**

Brass rod suspension with two way decorative scroll shown in polished brass and also in polished brass with a **G4** polished brass gallery and an **SPH200-AE** shade. Hand finished in either polished brass (-PB), old brass (-OB), black bronze (-BB), antique bronze (-AB), antique nickel (-AN), or bright chrome (-BC).

**Wiring:** 1x B22 (BC), 60 watt maximum globe holder(s)

**Depth:** 100mm  
**Suspension:** 12.700mm x 750mm

**BRS125D2-3**

Brass rod suspension with cast decorative three way scroll, shown in polished brass and in polished brass with a **G4** polished brass gallery and an **S950** shade. Hand finished in either polished brass (-PB), old brass (-OB), black bronze (-BB), antique bronze (-AB), antique nickel (-AN), or bright chrome (-BC).

**Wiring:** 1x B22 (BC), 60 watt maximum globe holder(s).

**Width:** 100mm **Depth:** 100mm  
**Suspension:** 12.700mm x 500mm



**BRS125D2-2**

Brass rod suspension with cast decorative two way scroll, shown in polished brass. Hand finished in either polished brass (-PB), old brass (-OB), black bronze (-BB), antique bronze (-AB), antique nickel (-AN), or bright chrome (-BC).

**Wiring:** 1x B22 (BC), 60 watt maximum globe holder(s).

**Depth:** 100mm  
**Suspension:** 12.700mm x 500mm

Brass rod suspension with offset swivel ceiling plate and woodblock. Shown in polished brass. Hand finished in either polished brass (-PB), old brass (-OB), black bronze (-BB), antique bronze (-AB), antique nickel (-AN), or bright chrome (-BC).

**Wiring:** 1x B22 (BC), 60 watt maximum globe holder(s).

**Width:** 120mm **Depth:** 120mm  
**Height:** 120mm + **Suspension:** 12.700mm x 500mm

**BRSO125**

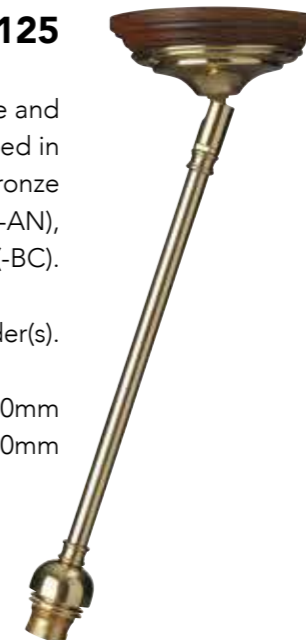

### BRS1275D6IGT

Brass rod suspension with decorative scroll and gas tap shown in polished brass with a **G2F** polished brass gallery and an **S3138** shade. Hand finished in either polished brass (-PB), old brass (-OB), black bronze (-BB), antique bronze (-AB), antique nickel (-AN), or bright chrome (-BC).

**Wiring:** 1x B22 (BC), 60 watt maximum globe holder(s).

**Depth:** 100mm

**Suspension:** 12.700mm x 750mm



### BRS1275IGT

Brass rod suspension with imitation gas tap shown in polished brass with a **G4** polished brass gallery and an **SPH200-OG** shade. Hand finished in either polished brass (-PB), old brass (-OB), black bronze (-BB), antique bronze (-AB), antique nickel (-AN), or bright chrome (-BC).

**Wiring:** 1x B22 (BC), 60 watt maximum globe holder(s).

**Depth:** 100mm

**Suspension:** 12.700mm x 750mm



### BRS1275D

Brass rod suspension with decorative spindle shown in polished brass with a **G4** polished brass gallery and an **SPH200-AE** shade. Hand finished in either polished brass (-PB), old brass (-OB), black bronze (-BB), antique bronze (-AB), antique nickel (-AN), or bright chrome (-BC).

**Wiring:** 1x B22 (BC), 60 watt maximum globe holder(s).

**Width:** 100mm **Depth:** 100mm

**Height:** 60mm + **Suspension:** 12.700mm x 750mm

Also available in lengths of 300mm (BRS123D), 500mm (BRS125D), 900mm (BRS129D) and 1000mm (BRS121D).



### BRS1275D

Brass rod suspension with decorative spindle shown in bright chrome.

Hand finished in either polished brass (-PB), old brass (-OB), black bronze (-BB), antique bronze (-AB), antique nickel (-AN), or bright chrome (-BC).

**Wiring:** 1x B22 (BC), 60 watt maximum globe holder(s).

**Width:** 100mm

**Depth:** 100mm

**Height:** 60mm +

**Suspension:** 12.700mm x 750mm

Also available in lengths of 300mm (BRS123D), 500mm (BRS125D), 900mm (BRS129D) and 1000mm (BRS121D).



### BRS121D

Brass rod suspension with decorative spindle, shown in bright chrome with a **G4** bright chrome gallery and an **S9012** shade. Hand finished in either polished brass (-PB), old brass (-OB), black bronze (-BB), antique bronze (-AB), antique nickel (-AN), or bright chrome (-BC).

**Wiring:** 1x B22 (BC), 60 watt maximum globe holder(s).

**Width:** 100mm **Depth:** 100mm

**Suspension:** 12.700mm x 1000mm



### BRS345D-G6DS

Brass rod suspension with decorative spindle and integrated G6DS gallery shown in black bronze. Hand finished in either polished brass (-PB), old brass (-OB), black bronze (-BB), antique bronze (-AB), antique nickel (-AN), or bright chrome (-BC).

**Wiring:** 1x B22 (BC), 60 watt maximum globe holder(s).

**Height:** 125mm + **Suspension:** 19.050mm x 500mm

**Width:** 160mm **Depth:** 160mm

Also available in lengths of 750mm (BRS3475D-G6DS), and 1000mm (BRS341D-G6DS).



### BRS3475D

Brass rod suspension with a decorative spindle, shown in black bronze with a **G6** black bronze gallery and an **S1400** shade.

Hand finished in either polished brass (-PB), old brass (-OB), black bronze (-BB), antique bronze (-AB), antique nickel (-AN), or bright chrome (-BC).

**Wiring:** 1x B22 (BC), 60 watt maximum globe holder(s).

**Width:** 100mm **Depth:** 100mm

**Height:** 60mm + **Suspension:** 19.050mm x 750mm

Brass rod suspension with a decorative spindle and an integrated G6DS gallery, shown in black bronze with an **S9014** shade.

Hand finished in either polished brass (-PB), old brass (-OB), black bronze (-BB), antique bronze (-AB), antique nickel (-AN), or bright chrome (-BC).

**Wiring:** 1x B22 (BC), 60 watt maximum globe holder(s).

**Width:** 100mm **Depth:** 100mm

**Height:** 200mm + **Suspension:** 19.050mm x 750mm

### BRS3475D-G6DS

### BRS345

Brass rod suspension shown in polished brass with a **G8** polished brass gallery and an **S4528MO** shade. Hand finished in either polished brass (-PB), old brass (-OB), black bronze (-BB), antique bronze (-AB), antique nickel (-AN), or bright chrome (-BC).

**Wiring:** 1x B22 (BC), 60 watt maximum globe holder(s).

**Height:** 90mm + **Suspension:** 19.050mm x 500mm

**Width:** 210mm **Depth:** 210mm



### BRS345

Brass rod suspension shown in polished brass with a **G8** polished brass gallery and an **S4972** shade. Hand finished in either polished brass (-PB), old brass (-OB), black bronze (-BB), antique bronze (-AB), antique nickel (-AN), or bright chrome (-BC).

**Wiring:** 1x B22 (BC), 60 watt maximum globe holder(s).

**Width:** 210mm **Depth:** 210mm

**Height:** 90mm +

**Suspension:** 19.050mm x 500mm



### BRS345D

Brass rod suspension with decorative spindle shown in black bronze. Hand finished in either polished brass (-PB), old brass (-OB), black bronze (-BB), antique bronze (-AB), antique nickel (-AN), or bright chrome (-BC).

**Wiring:** 1x B22 (BC), 60 watt maximum globe holder(s).

**Width:** 100mm **Depth:** 100mm

**Height:** 70mm + **Suspension:** 19.050mm x 500mm

Also available in lengths of 750mm (BRS3475D), and 1000mm (BRS341D).



### BRS3475D145

Brass rod suspension with decorative column. Shown in polished brass with a **G8** polished brass gallery and an **S982** glass shade. Hand finished in either polished brass (-PB), old brass (-OB), black bronze (-BB), antique bronze (-AB), antique nickel (-AN), or bright chrome (-BC).

**Wiring:** 1x B22 (BC), 60 watt maximum globe holder(s).

**Width:** 210mm **Depth:** 210mm

**Height:** 170mm + **Suspension:** 19.050mm x 750mm



### BRS3475D-DC

Brass rod suspension with a decorative spindle and a decorative cup shown in polished brass with an **S4746** glass shade. Hand finished in either polished brass (-PB), old brass (-OB), black bronze (-BB), antique bronze (-AB), antique nickel (-AN), or bright chrome (-BC).

**Wiring:** 1x B22 (BC), 60 watt maximum globe holder(s).

**Width:** 100mm **Depth:** 100mm

**Height:** 80mm + **Suspension:** 19.050mm x 750mm



### BRS5875D145

Brass rod suspension with a cast decorative column, shown in black bronze with a **G4** black bronze gallery and an **S1122** shade. Hand finished in either polished brass (-PB), old brass (-OB), black bronze (-BB), antique bronze (-AB), antique nickel (-AN), or bright chrome (-BC).

**Wiring:** 1x B22 (BC), 60 watt maximum globe holder(s).

**Width:** 100mm **Depth:** 100mm

**Height:** 200mm + **Suspension:** 15.875mm x 750mm



### BRS3475D102

Brass rod suspension with a cast decorative column, shown in polished brass with a **G4** polished brass gallery and an **S2705** shade.

Hand finished in either polished brass (-PB), old brass (-OB), black bronze (-BB), antique bronze (-AB), antique nickel (-AN), or bright chrome (-BC).

**Wiring:** 1x B22 (BC), 60 watt maximum globe holder(s).

**Width:** 100mm **Depth:** 100mm

**Height:** 200mm + **Suspension:** 19.050mm x 750mm



### BRS3475D102-G6DS

Brass rod suspension with a cast decorative column and integrated G6DS gallery, shown in antique bronze with an **S4154** shade.

Hand finished in either polished brass (-PB), old brass (-OB), black bronze (-BB), antique bronze (-AB), antique nickel (-AN), or bright chrome (-BC).

**Wiring:** 1x B22 (BC), 60 watt maximum globe holder(s).

**Width:** 160mm **Depth:** 160mm

**Height:** 200mm + **Suspension:** 19.050mm x 750mm





### CS3-G6DS

Chain suspension, C8 heavy steel chain and brown cotton flex, with an integrated G6DS deep gallery. Shown in black bronze with an **S40** shade. Hand finished in either polished brass (-PB), black bronze (-BB), or bright chrome (-BC).

**Wiring:** 1x B22 (BC), 60 watt maximum globe holder(s).

**Width:** 160mm **Depth:** 160mm

**Height:** 200mm + **Suspension:** C8 chain x 1000mm

-BC comes standard with black cotton flex cable.



### CS3

Chain suspension, C8 heavy steel chain and brown cotton flex, shown in black bronze with a **G6** black bronze gallery and an **S2400** shade. Hand finished in either polished brass (-PB), black bronze (-BB), or bright chrome (-BC).

**Wiring:** 1x B22 (BC), 60 watt maximum globe holder(s).

**Width:** 160mm **Depth:** 160mm

**Height:** 100mm + **Suspension:** C8 chain x 1000mm

-BC comes standard with black cotton flex cable.

### CS1

Chain suspension, C9 steel oval link chain, shown in polished brass with brown cotton flex. Hand finished in either polished brass (-PB), black bronze (-BB), or bright chrome (-BC).

**Wiring:** 1x B22 (BC), 60 watt maximum globe holder(s).

**Width:** 120mm **Depth:** 120mm

**Height:** 120mm +

**Suspension:** C9 chain x 1000mm

-BC comes standard with black cotton flex cable.

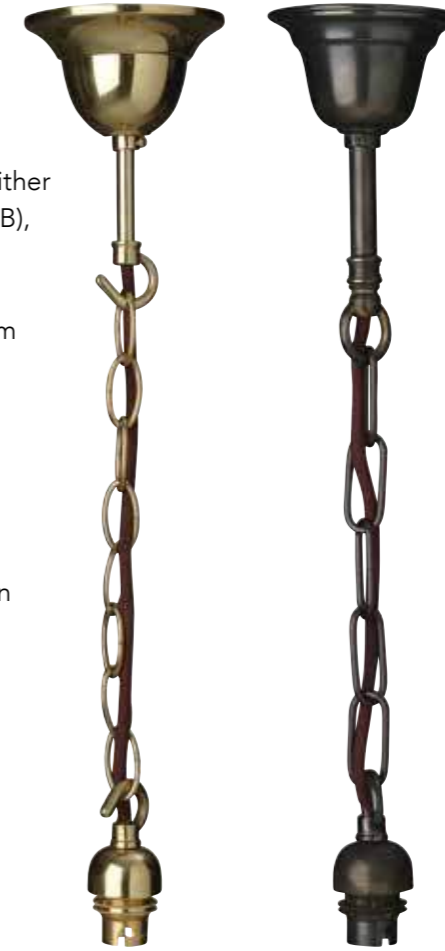

### CS2

Chain suspension, C9 steel oval link chain, shown in polished brass with brown cotton flex. Hand finished in either polished brass (-PB), black bronze (-BB), or bright chrome (-BC).

**Wiring:** 1x B22 (BC), 60 watt maximum globe holder(s).

**Width:** 120mm **Depth:** 120mm

**Height:** 120mm +

**Suspension:** C9 chain x 1000mm

-BC comes standard with black cotton flex cable.

### CS3

Chain suspension, C8 heavy steel chain, shown in black bronze with brown cotton flex. Hand finished in either polished brass (-PB), black bronze (-BB), or bright chrome (-BC).

**Wiring:** 1x B22 (BC), 60 watt maximum globe holder(s).

**Width:** 120mm **Depth:** 120mm

**Height:** 120mm +

**Suspension:** C8 chain x 1000mm

-BC comes standard with black cotton flex cable.



### CS4

Chain suspension C9 oval link chain, shown in black bronze with brown cotton flex. Hand finished in either polished brass (-PB), black bronze (-BB), or bright chrome (-BC).

**Wiring:** 1x B22 (BC), 60 watt maximum globe holder(s).

**Width:** 80mm **Depth:** 80mm

**Height:** 065mm +

**Suspension:** C9 chain x 1000mm

-BC comes standard with black cotton flex cable.

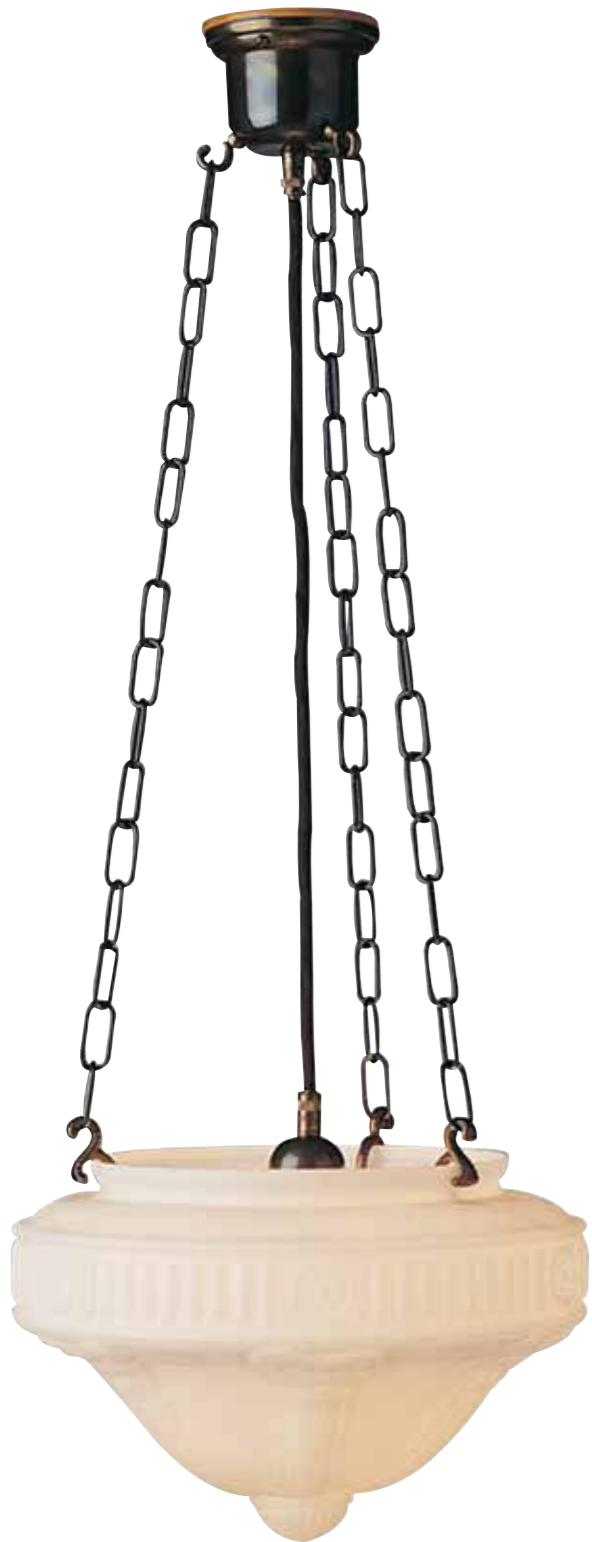

### BLCS3

Brass link three chain suspension, shown in black bronze with an **S4528** glass shade and brown cotton flex cable. Hand finished in either polished brass (-PB), black bronze (-BB), or bright chrome (-BC).

**Wiring:** 1x B22 (BC), 60 watt maximum globe holder(s).

**Height:** 90mm + **Suspension:** C6 chain x 1000mm

-BC comes standard with black cotton flex cable.

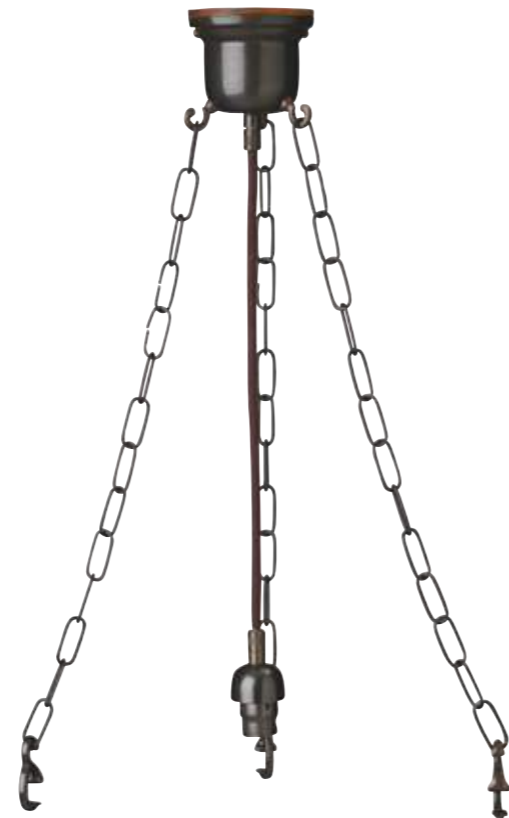

### BLCS3

Brass link three chain suspension, shown in black bronze with brown cotton flex cable. Hand finished in either polished brass (-PB), black bronze (-BB), or bright chrome (-BC).

**Wiring:** 1x B22 (BC), 60 watt maximum globe holder(s).

**Height:** 90mm + **Suspension:** C6 chain x 1000mm

-BC comes standard with black cotton flex cable.



### BLCS3

Brass link three chain suspension, shown in polished brass with an **S1222-OM** glass shade and brown cotton flex cable. Hand finished in either polished brass (-PB), black bronze (-BB), or bright chrome (-BC).

**Wiring:** 1x B22 (BC), 60 watt maximum globe holder(s).

**Height:** 90mm + **Suspension:** C6 chain x 1000mm

-BC comes standard with black cotton flex cable.

### BLCS3

Brass link three chain suspension, shown in black bronze with an **S018** glass shade and brown cotton flex cable. Hand finished in either polished brass (-PB), black bronze (-BB), or bright chrome (-BC).

**Wiring:** 1x B22 (BC), 60 watt maximum globe holder(s).

**Height:** 90mm +

**Suspension:** C6 chain x 1000mm

-BC comes standard with black cotton flex cable.

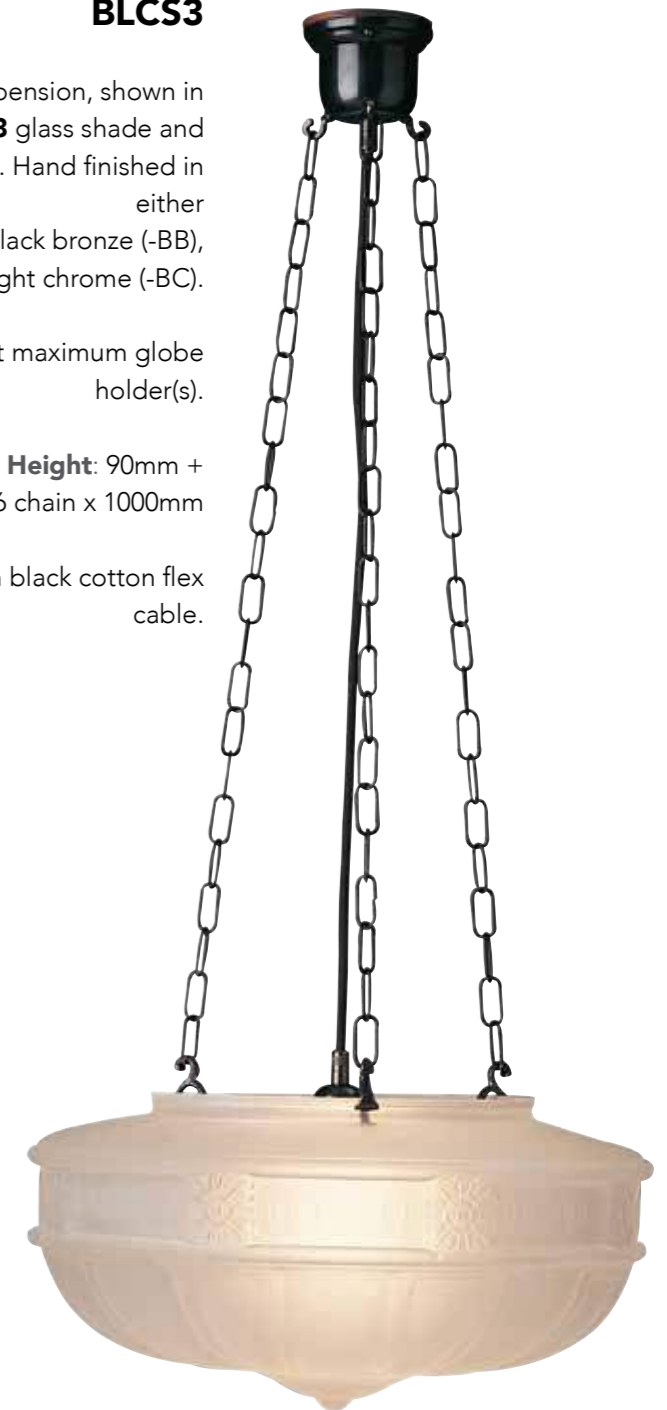



**BLCS6**

Brass link three chain suspension with hooks, shown in black bronze with an **S900** glass shade with brown cotton flex cable. Hand finished in either polished brass (-PB), old brass (-OB), black bronze (-BB), antique bronze (-AB), antique nickel (-AN) or bright chrome (-BC).

**Wiring:** 1x B22 (BC), 60 watt maximum globe holder(s).

**Height:** 100mm + **Suspension:** C475 chain x 3 x 1000mm

-AN and -BC finishes has black cotton flex cable.

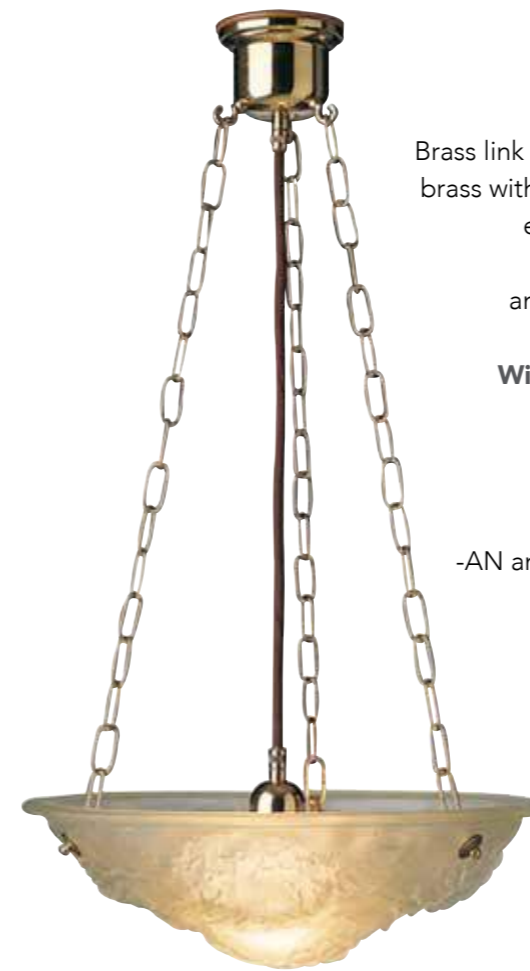

**BLCS11**

Brass link three chain suspension, shown in polished brass with brown cotton flex cable. Hand finished in either polished brass (-PB), old brass (-OB), black bronze (-BB), antique bronze (-AB), antique nickel (-AN), or bright chrome (-BC).

**Wiring:** 1x B22 (BC), 60 watt maximum globe holder(s).

**Suspension:** C475 chain x 3 x 1000mm

-AN and -BC finishes has black cotton flex cable.

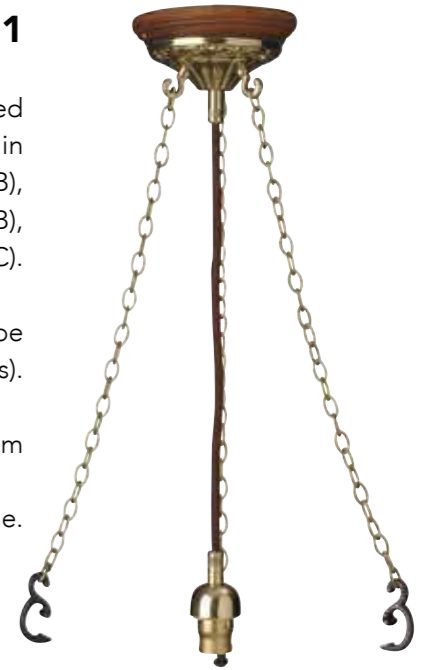

**BLCS7**

Brass link three chain suspension, shown in polished brass with brown cotton flex cable. Hand finished in either polished brass (-PB), old brass (-OB), black bronze (-BB), antique bronze (-AB), antique nickel (-AN), or bright chrome (-BC).

**Wiring:** 1x B22 (BC), 60 watt maximum globe holder(s).

**Height:** 100mm + **Suspension:** C475 chain x 3 x 1000mm

**BLCS5**

Brass link three chain suspension with studs, shown in polished brass with an **S1018** glass shade and brown cotton flex cable. Hand finished in either polished brass (-PB), black bronze (-BB), or bright chrome (-BC).

**Wiring:** 1x B22 (BC), 60 watt maximum globe holder(s).

**Height:** 90mm + **Suspension:** C475 chain x 3 x 1000mm

-BC finish has black cotton flex cable.

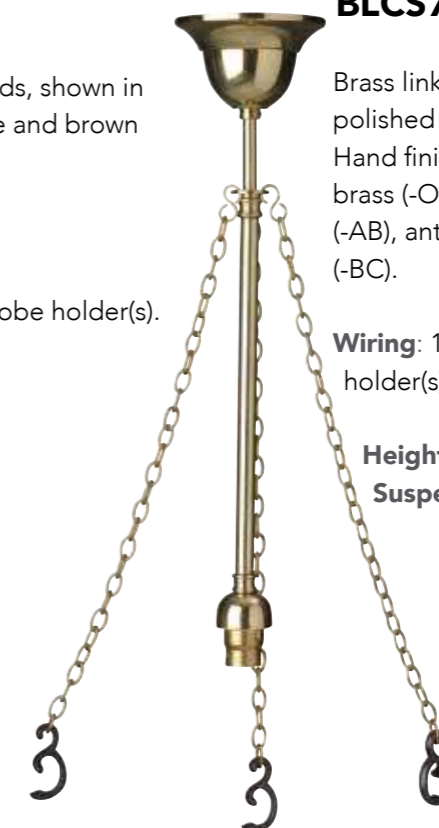

### BRS1213CS

Brass rod suspension 12.7mm (1/2") x 1000mm with 3 chains and studs, shown in polished brass with an **S1565-40** glass shade. Hand finished in either polished brass (-PB), old brass (-OB), black bronze (-BB), antique bronze (-AB), antique nickel (-AN), or bright chrome (-BC).

**Wiring:** 1x B22 (BC), 60 watt maximum globe holder(s).

**Width:** 100mm **Depth:** 100mm

**Height:** 500mm + **Suspension:** 3x C475 chain x 500mm



### BRS-FITZROY

Fitzroy brass rod suspension 1/2" patterned tube with 3 chains and patterned tube ring to hold glass. Shown in antique bronze with an **S6946** glass shade. Hand finished in either polished brass (-PB), old brass (-OB), black bronze (-BB), antique bronze (-AB), antique nickel (-AN), or bright chrome (-BC).

**Wiring:** 1x B22 (BC), 60 watt maximum globe holder(s).

**Width:** 350mm **Depth:** 350mm

**Height:** 500mm + **Suspension:** 12.700mm x 500mm patterned.



### BRS1213S

Brass rod suspension 1/2" x 1 metre with 3 stays and hooks, shown in polished brass. Hand finished in either polished brass (-PB), old brass (-OB), black bronze (-BB), antique bronze (-AB), antique nickel (-AN), or bright chrome (-BC).

**Wiring:** 1x B22 (BC), 60 watt maximum globe holder(s).

**Width:** 100mm **Depth:** 100mm

**Height:** 500mm + **Suspension:** 12.700mm x 500mm.

Also available as shown below with studs (BRS1213SS) shown with an **S4530** glass shade.



### BRS1213LC

Brass rod suspension 1/2" x 1 metre with 3 links of chain and hooks shown in antique nickel with an **S018-OM** shade, and above in polished brass. Hand finished in either polished brass (-PB), old brass (-OB), black bronze (-BB), antique bronze (-AB), antique nickel (-AN), or bright chrome (-BC).

**Wiring:** 1x B22 (BC), 60 watt maximum globe holder(s).

**Width:** 100mm **Depth:** 100mm

**Height:** 500mm + **Suspension:** 12.700mm x 500mm.



**BRS-GOUGER**

Gouger Brass suspension with 1/2" rod and 3 stays and hooks attached to a ring to hold a glass shade, shown in polished brass with an **S4495** glass. Hand finished in either polished brass (-PB), old brass (-OB), black bronze (-BB), antique bronze (-AB), antique nickel (-AN), or bright chrome (-BC).

**Wiring:** 2x B22 (BC), 60 watt maximum globe holder(s).

**Width:** 120mm **Depth:** 120mm  
**Suspension:** 12.700mm x 500mm and 3 stays.



**BS12**

Brass suspension with 1/2" rod and 3 stays and hooks shown in polished brass Hand finished in either polished brass (-PB), old brass (-OB), black bronze (-BB), antique bronze (-AB), antique nickel (-AN), or bright chrome (-BC).

**Wiring:** 1x B22 (BC), 60 watt maximum globe holder(s).

**Width:** 120mm **Depth:** 120mm  
**Height:** 100mm + **Suspension:** 12.700mm x 500mm and 3 stays.



**BS10**

Brass suspension with 1/2" rod and 3 links of C475 chain and hooks shown in polished brass with an **S4972-OM** shade, and above in polished brass. Hand finished in either polished brass (-PB), old brass (-OB), black bronze (-BB), antique bronze (-AB), antique nickel (-AN), or bright chrome (-BC).

**Wiring:** 1x B22 (BC), 60 watt maximum globe holder(s).

**Width:** 120mm **Depth:** 120mm  
**Suspension:** 12.700mm x 500mm and 3x C475 chains.

Also available with studs instead of hooks (BS10S).



**BS12S**

Brass suspension with 1/2" rod and 3 stays and studs. shown in polished brass with an **S1565-40** shade. Hand finished in either polished brass (-PB), old brass (-OB), black bronze (-BB), antique bronze (-AB), antique nickel (-AN), or bright chrome (-BC).

**Wiring:** 1x B22 (BC), 60 watt maximum globe holder(s).

**Width:** 120mm **Depth:** 120mm  
**Height:** 100mm + **Suspension:** 12.700mm x 500mm and 3 stays.



### BRS3CRG

Clarence Brass rod set 12.7mm (1/2") by 500mm with 3 side chain suspensions and ring and finial fitting to suit an S92111 glass shade. Shown in polished brass with an **S92111** glass bowl (separate item). Hand finished in either polished brass (-PB), old brass (-OB), black bronze (-BB), antique bronze (-AB), antique nickel (-AN), bright chrome (-BC), or powder coated (-PC).

**Wiring:** 1x B22 (BC), 60 watt maximum globe holder(s).

**Weight:** 1.1Kg **Width:** 450mm **Depth:** 450mm  
**Height:** 600mm + **Suspension:** 12.700mm x 500mm.



### BRS3SRG

Pitt Brass rod set 12.7mm (1/2") by 500mm with 3 side stay suspensions and ring and finial fitting to suit an S92111 glass shade. Shown in polished brass with an **S92111** glass bowl (separate item) Hand finished in either polished brass (-PB), old brass (-OB), black bronze (-BB), antique bronze (-AB), antique nickel (-AN), bright chrome (-BC), or powder coated (-PC).

**Wiring:** 1x B22 (BC), 60 watt maximum globe holder(s)

**Width:** 450mm **Depth:** 450mm **Weight:** 1.1Kg  
**Height:** 600mm + **Suspension:** 12.700mm x 500mm.



### BRS12-3LH

Brass rod suspension 12.700mm (1/2") by 500mm with 3 offset swivel globe holders. Shown in polished brass brass. Hand finished in either polished brass (-PB), old brass (-OB), black bronze (-BB), antique bronze (-AB), antique nickel (-AN), bright chrome (-BC), or powder coated (-PC).

**Wiring:** 3x B22 (BC), 60 watt maximum globe holder(s).

**Weight:** 1.1Kg **Width:** 120mm **Depth:** 120mm  
**Height:** 500mm +  
**Suspension:** 15.875mm x 500mm.



### BRS3R3LH

York brass rod set 12.7mm (1/2") by 500mm with 3 side stay suspensions and a 3 globe holder plate to suit an S92111 glass. Shown in polished brass brass with an **S92111** glass bowl (separate item) Hand finished in either polished brass (-PB), old brass (-OB), black bronze (-BB), antique bronze (-AB), antique nickel (-AN), bright chrome (-BC), or powder coated (-PC).

**Wiring:** 3x B22 (BC), 60 watt maximum globe holder(s).

**Weight:** 1.1Kg **Width:** 120mm **Depth:** 120mm  
**Height:** 500mm + **Suspension:** 15.875mm x 500mm.



### BRS3LHF

Brass rod suspension with three globe holders fixed and bottom plate and finial. Shown in polished brass brass with an **S92474** glass bowl (separate item). Hand finished in either polished brass (-PB), old brass (-OB), black bronze (-BB), antique bronze (-AB), antique nickel (-AN), bright chrome (-BC), or powder coated (-PC).

**Wiring:** 3x B22 (BC), 60 watt maximum globe holder(s).

**Width:** 100mm **Depth:** 100mm  
**Height:** 200mm + **Suspension:** 12.700mm x 500mm.

### BRS5813SS

Brass rod set 15.875mm (5/8") by one metre with 3 side stays suspension fitting shown in polished brass and below in polished brass with a **S1564-50** glass bowl (separate item; left) as well as in antique bronze with a **S4531** glass bowl (separate item; right). Includes three side stays. Hand finished in either polished brass (-PB), old brass (-OB), black bronze (-BB), antique bronze (-AB), antique nickel (-AN), bright chrome (-BC), or powder coated (-PC).

**Wiring:** 3x B22 (BC), 60 watt maximum globe holder(s).

**Weight:** 1.1Kg **Width:** 120mm **Depth:** 120mm  
**Height:** 500mm + **Suspension:** 15.875mm x 500mm.



### BRS5813LC

Brass rod set 15.875mm (5/8") by one metre with 3 lengths of chain suspension fitting shown in polished brass and in old brass with a **S920** glass bowl (separate item). Includes three lengths 19mm thick welded brass chain. Hand finished in either polished brass (-PB), old brass (-OB), black bronze (-BB), antique bronze (-AB), antique nickel (-AN), bright chrome (-BC), or powder coated (-PC).

**Wiring:** 3x B22 (BC), 60 watt maximum globe holder(s).

**Weight:** 1.1Kg **Width:** 120mm **Depth:** 120mm  
**Height:** 500mm + **Suspension:** 15.875mm x 500mm.



**SS1-E27 + S1279**

Modern wire ceiling suspension with a holophane styled glass dome shade

**Wiring:** 1x E27 (ES), 60 watt maximum globe holder(s).

**Weight:** 1.3Kg **Width:** 350mm **Depth:** 350mm

**Height:** 210mm + **Suspension:** 1000mm SS wire + Clear PVC.



**SS1-G2GS-ELH**

Stainless steel wire suspension with clear pvc flex, an integrated G2GS cast gallery and an extended lamp holder shown in satin nickel with an **S1030** shade.

**Wiring:** 1x B22 (BC), 60 watt maximum globe holder(s).

**Width:** 100mm **Depth:** 100mm

**Height:** 300mm + **Suspension:** 1000mm SS wire.



**SS2-3SPYS**

Modern stainless steel ceiling suspension. Shown with **S6835-W** white shade.

**Wiring:** 1x B22 (BC), 60 watt maximum globe holder(s).

**Weight:** 1.2Kg **Width:** 355mm **Depth:** 355mm

**Height:** 200mm + **Suspension:** 1000mm Clear PVC

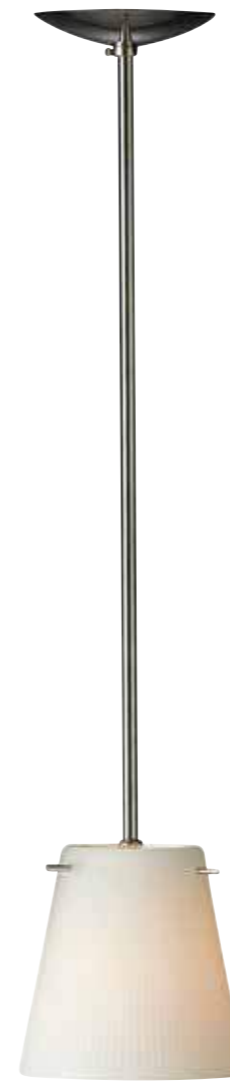

**SS2-3SPY**

Modern stainless steel ceiling suspension. Shown with **S6752T** glass shade

**Wiring:** 1x B22 (BC), 60 watt maximum globe holder(s).

**Width:** 355mm

**Depth:** 355mm

**Weight:** 1.2Kg

**Height:** 200mm +

**Suspension:** 1000mm Clear PVC

**FM27-C14 Suspension:** 2400mm Cotton Coverd Cord in Brown  
**FM27-C19 Suspension:** 2400mm Cotton Coverd Cord in Black Twisted  
**FM27-C2 Suspension:** 2400mm Cotton Coverd Cord in Black  
**FM27-C29 Suspension:** 2400mm Cotton Coverd Cord in Black & White  
 Globes shown not included, available separately, see page 126-131.

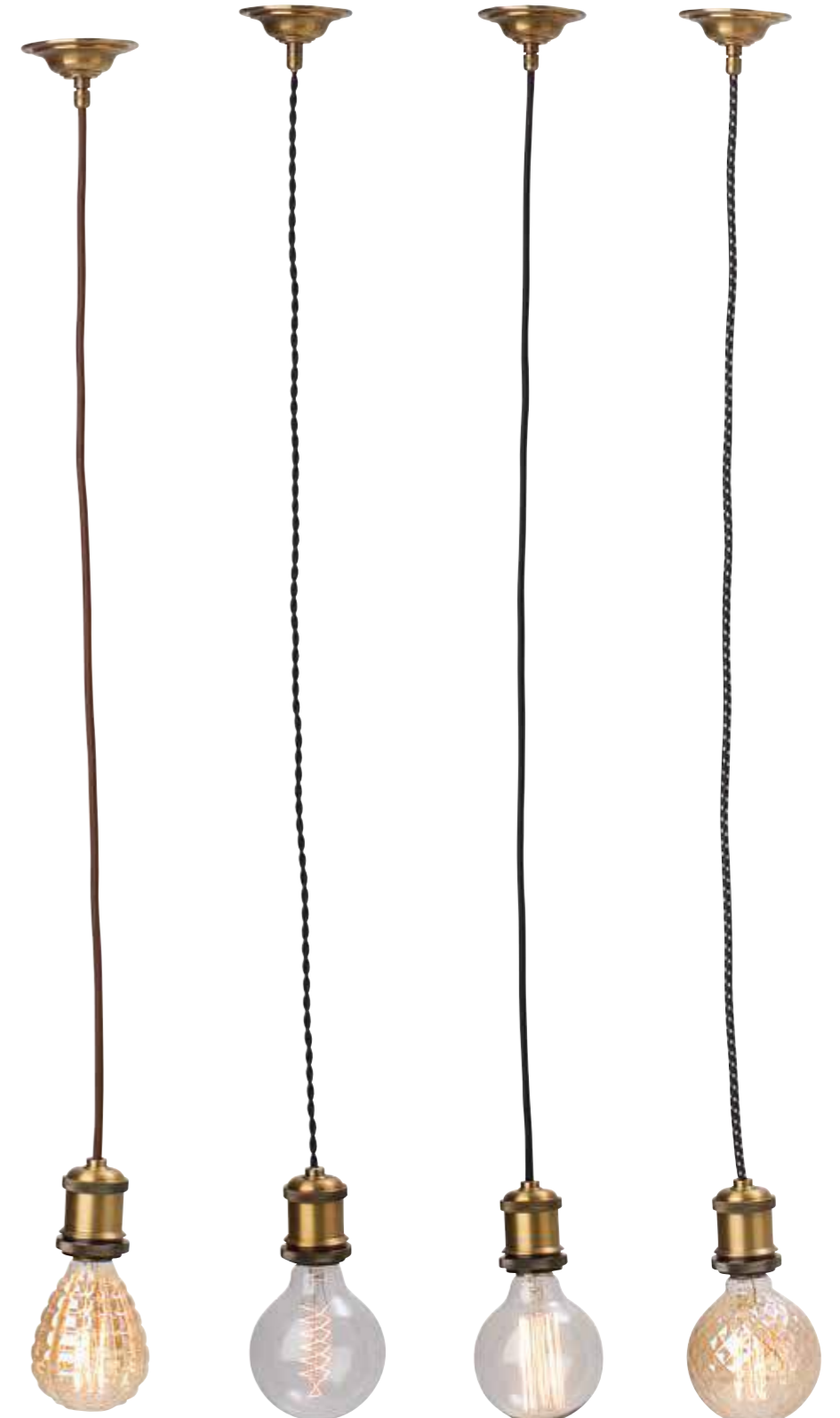



### FM7014-1

Turret, Jeremy Pyles replica stylish glass ceiling suspension, North American hand blown tear drop glass design inspired by iconic towers that decorate Moorish architecture. Shown with a **VIN-T9-60-ES** (Globe, separate item).

**Wiring:** 1x E27 (ES), 60 watt maximum globe holder(s).

**Weight:** 1.4Kg **Width:** 175mm **Depth:** 175mm  
**Height:** 300mm + **Suspension:** 1800mm Black Cotton flex.



### FM7015-1

Minaret, Jeremy Pyles replica stylish glass ceiling suspension, North American hand blown tear drop glass design inspired by iconic towers that decorate Moorish architecture. Shown with a **VIN-T45-60-ES** (Globe, separate item).

**Wiring:** 1x E27 (ES), 60 watt maximum globe holder(s).

**Weight:** 1.2Kg **Width:** 285mm **Depth:** 285mm  
**Height:** 210mm +  
**Suspension:** 1800mm Black Cotton flex.



### FM7035-1

Aurora, Jeremy Pyles replica stylish glass ceiling suspension, North American design featuring a hand blown lipped curvature glass body. Shown with a **VIN-T45-60-ES** (Globe, separate item).

**Wiring:** 1x E27 (ES), 60 watt maximum globe holder(s).

**Weight:** 1.1Kg **Width:** 315mm **Depth:** 315mm  
**Height:** 190mm + **Suspension:** 1800mm Black Cotton flex.

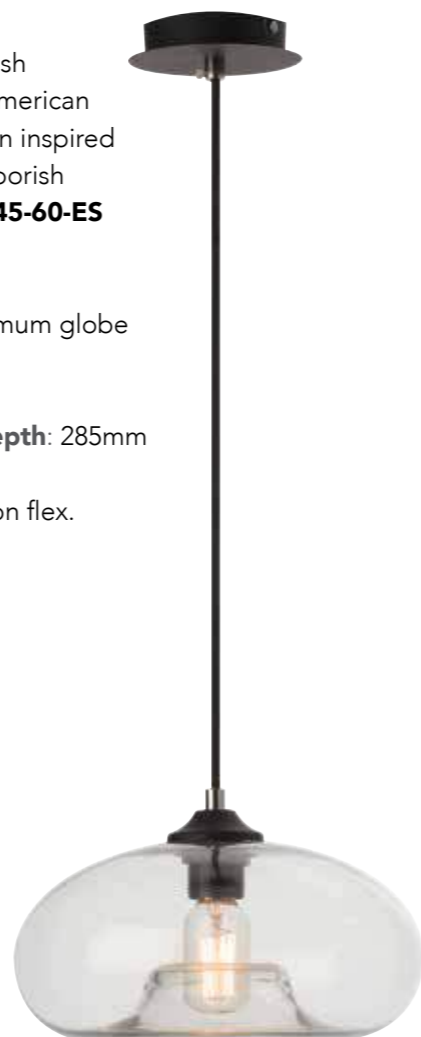

- FM24-2** Yellow cotton covered cord suspension with black canopy
- FM24-3** Orange cotton covered cord suspension with black canopy
- FM24-5** Black & White cotton covered cord suspension with black canopy
- FM24-6** White cotton covered cord suspension with black canopy
- FM24-7** Black cotton covered cord suspension with black canopy
- FM24-12** Pink cotton covered cord suspension with black canopy
- FM24-14** Turquoise cotton covered cord suspension with black canopy
- FM24-15** Blue cotton covered cord suspension with black canopy
- FM2PB** Black cotton covered cord suspension, porcelain globe holder & SS plate.
- FM2PP** White cotton covered cord suspension with porcelain ceiling plate.

**FM26** - The same colour cord suspension with a white E27 globe holder with shade ring and white canopy.

**Wiring:** 1x E27 (ES), 60 watt maximum globe holder(s).

**Weight:** 0.4Kg **Width:** 100mm **Depth:** 100mm  
**Height:** 160mm + **Suspension:** 2500mm Cotton.

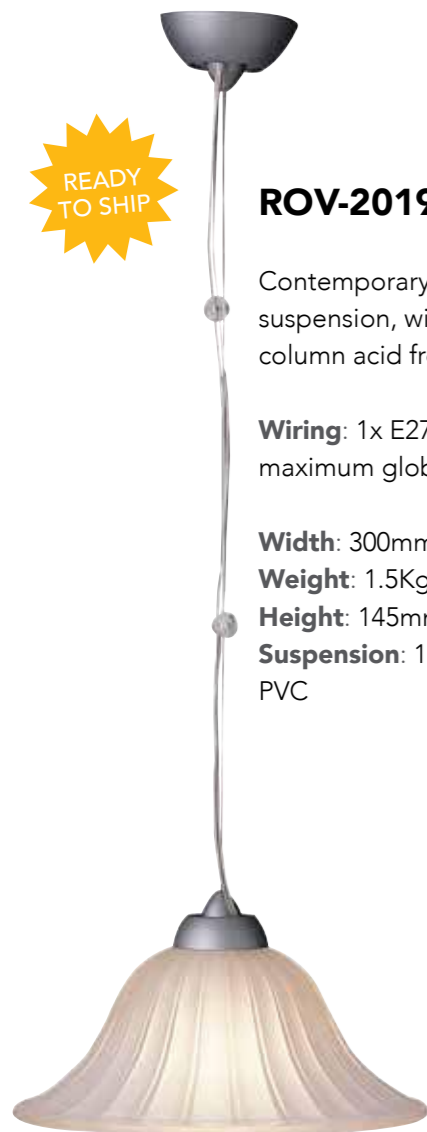

**ROV-2019S + S4746**

Contemporary wire ceiling suspension, with an **S4746** fluted column acid frost glass shade.

**Wiring:** 1x E27 (ES), 60 watt maximum globe holder(s).

**Width:** 300mm **Depth:** 300mm

**Weight:** 1.5Kg

**Height:** 145mm +

**Suspension:** 1000mm SS wire + Clear PVC

**ROV-2019S + S1279**

Contemporary wire ceiling suspension with a holophane styled glass dome shade.

**Wiring:** 1x E27 (ES), 60 watt maximum globe holder(s)

**Weight:** 1.3Kg

**Width:** 350mm

**Depth:** 350mm

**Height:** 210mm +

**Suspension:** 1000mm SS wire + Clear PVC.

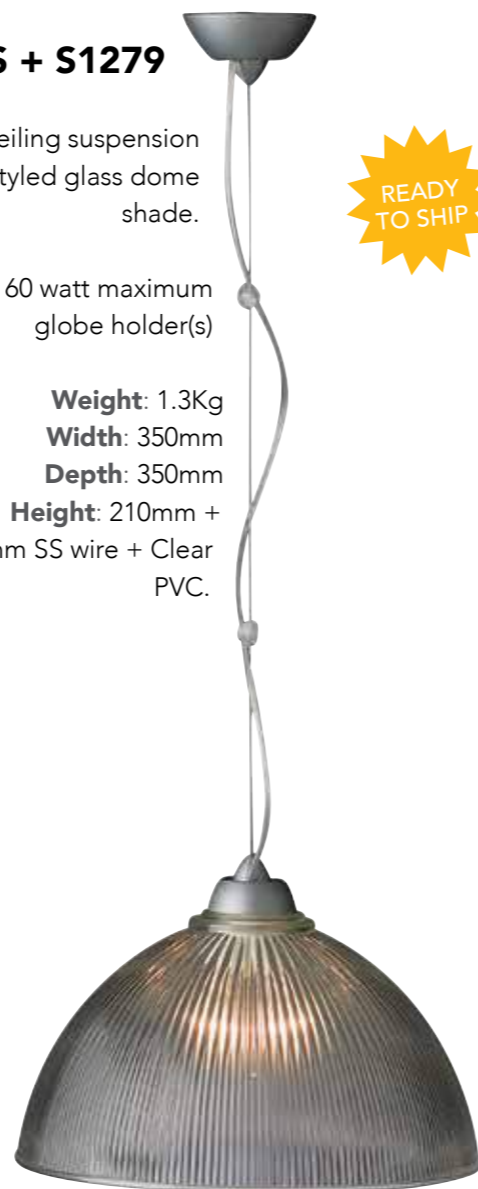

**ROV-2019S + S92474**

Contemporary wire ceiling suspension, with an **S92474** fluted column acid frost glass shade.

**Wiring:** 1x E27 (ES), 60 watt maximum globe holder(s).

**Weight:** 1.5Kg

**Width:** 400mm **Depth:** 400mm

**Height:** 170mm +

**Suspension:** 1000mm SS wire + Clear PVC



**MK-SUSPENSION + SMC14-SN**

Industrial satin nickel conical shade ceiling suspension.

**Wiring:** 1x B22 (BC), 60 watt maximum globe holder(s).

**Weight:** 1.2Kg

**Width:** 355mm **Depth:** 355mm

**Height:** 200mm + **Suspension:** 1000mm Clear PVC



**MK-SUSPENSION + SML14-SN**

Industrial satin nickel dome shade ceiling suspension.

**Wiring:** 1x B22 (BC), 60 watt maximum globe holder(s).

**Weight:** 1.3Kg

**Width:** 355mm **Depth:** 355mm

**Height:** 210mm + **Suspension:** 1000mm Clear PVC



READY  
TO SHIP

**PD2102**

Contemporary conical glass dome ceiling suspension, shown with VIN-ST64-60-ES (globe, separate item). Available in black with clear glass only.

**Wiring:** 1x E27 (ES), 60 watt maximum globe holder(s).

**Weight:** 1.9Kg

**Suspension:** 1000mm black PVC



**PD1279**

Contemporary holophane style glass dome ceiling suspension, shown in bright chrome also available in satin nickel.

**Wiring:** 1x E27 (ES), 60 watt maximum globe holder(s).

**Weight:** 3.2Kg **Width:** 365mm **Depth:** 365mm

**Height:** 255mm + **Suspension:** 1000mm oval chain



READY  
TO SHIP

**PD2199-SN**

Industrial ribbed dome ceiling suspension, with frosted glass diffuser. Available in satin nickel and black bronze. Includes three joining rods for adjustable total height plus a swivel for angled ceilings.

**Wiring:** 1x E27 (ES), 60 watt maximum globe holder(s).

**Weight:** 2.2Kg **Width:** 350mm **Depth:** 350mm

**Height:** 320mm + **Suspension:** 1150 max



**PD2199-BZ**

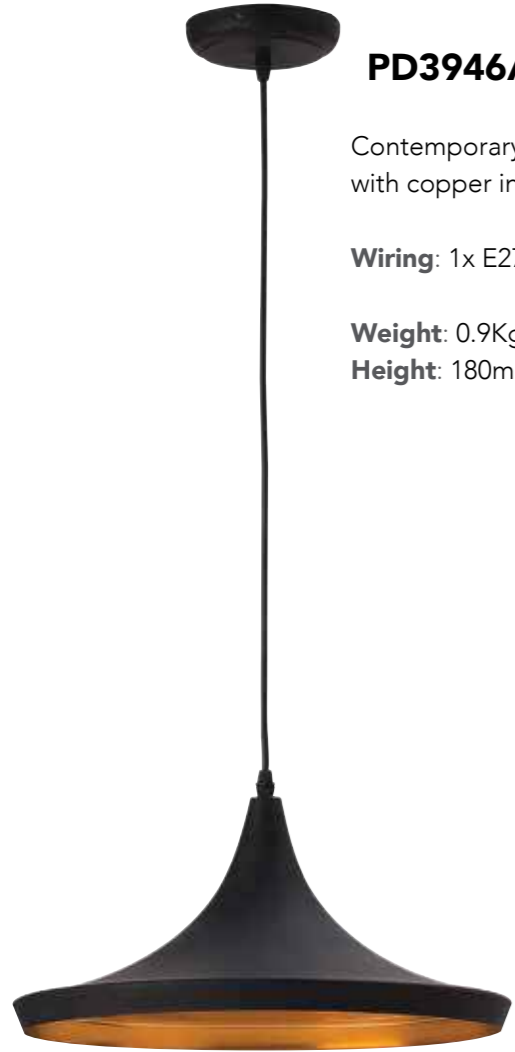

**PD3946A**

Contemporary wide matt black Tom Dixon replica ceiling suspension, with copper inside, English design inspired by indian cookware.

**Wiring:** 1x E27 (ES), 60 watt maximum globe holder(s).

**Weight:** 0.9Kg **Width:** 365mm **Depth:** 365mm  
**Height:** 180mm + **Suspension:** 1000mm Black PVC.



**PD3946C**

Contemporary skinny matt black Tom Dixon replica ceiling suspension, with copper inside, English design inspired by indian cookware.

**Wiring:** 1x E27 (ES), 60 watt maximum globe holder(s).

**Weight:** 0.6Kg **Width:** 185mm **Depth:** 185mm  
**Height:** 380mm + **Suspension:** 1000mm Black PVC.



**PD3946B**

Contemporary fat matt black Tom Dixon replica ceiling suspension, with copper inside, English design inspired by indian cookware.

**Wiring:** 1x E27 (ES), 60 watt maximum globe holder(s).

**Weight:** 0.8Kg **Width:** 240mm **Depth:** 240mm  
**Height:** 300mm + **Suspension:** 1000mm Black PVC.



**PD2140**

Contemporary black bronze soldered pipe star ceiling suspension, shown with **VIN-T9-60-E27** (globe, separate item).

**Wiring:** 1x E27 (ES), 60 watt maximum globe holder(s).

**Weight:** 3.1Kg **Width:** 400mm **Depth:** 400mm  
**Height:** 425mm + **Suspension:** 1000mm oval chain



**PD6119**

Contemporary black bronze square tube round cage ceiling suspension.

**Wiring:** 3x B15 (SBC), 60 watt maximum globe holder(s).

**Weight:** 3.6Kg **Width:** 415mm **Depth:** 415mm  
**Height:** 425mm + **Suspension:** 1000mm oval chain





### PD0187P-6A

Inspirational contemporary Matt Black orb shaped ceiling suspension.

**Wiring:** 6x E14 (SES), 60 watt maximum globe holder(s).

**Weight:** 5.3Kg **Width:** 500mm **Depth:** 500mm  
**Height:** 500mm + **Suspension:** 1000mm chain



### PD038P

Large industrial contemporary Matt Black dome suspension with golden interior.

**Wiring:** 1x E27 (ES), 60 watt maximum globe holder(s).

**Weight:** 4.3Kg **Width:** 540mm **Depth:** 540mm  
**Height:** 230mm + **Suspension:** 1000mm suspension wire.

# Ceiling - Float Lights

The right kind of lighting is often the best way to really spruce up a section of your interior. For areas needing a subtle, dim ambience to highlight your décor, a float light may be a perfect fit. Float lights deliver a soft, delicate illumination which provides an even, subdued light; a great way to provide a gentle yet noticeable elevation in ambience.

At Robert Kitto, our premium collection of float lights are constructed with extreme care and designed to perfection. These lights can highlight the best from your interiors, with our range encapsulating a variety of requirements.

Similar to our pendant lighting, float lamps are now progressively entering the modern market. Our new Côte d'Azur style glass lamps displays this contemporary style, finished in bright chrome, the metal ware is made to precisely fit the stylish ribbed glass completing an amazing modern float lamp.

In addition to contemporary styles, we still have our range of traditional brass float lamps, hand assembled here in Australia. The brass metal ware can be customised with our range of beautiful finishes including; old brass, antique bronze and antique nickel.

Robert Kitto Lighting is proud to offer a wide selection of glass patterns and sizes, with five glass sizes between 180 millimetres and 400 millimetres wide in plain glass or with decorative diamond or grape patterns also available.

With our hand assembled float lamps made here in Australia, a high range of customisation is available in a timely manner, allowing your Robert Kitto float light to grace your ceilings in a short period of time.

The PD series of lamps offers yet another lighting experience. Our PD models are great for a stylish and rustic ambience, with their optical effects from their glass exteriors perfect for heightening and enhancing features and elements of your space. In addition, the suspensions and chains used, are made from high quality material, which means these lights are not only attractive and practical, but also durable allowing years of use without the need for repairs or replacement.

At Robert Kitto Lighting, we can provide the right lighting solutions for all your lighting requirements.

The Crafters Hotel, South Australia.  
5 Float Lamps of varying glass patterns and sizes clustered together and hanging on chain.



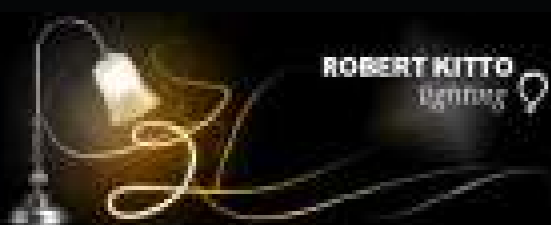

### FL-PD1057

Tall decorative framed rustic bronze ceiling float lamp, with plain clear glass.

**Wiring:** 3x B15 (SBC), 60 watt maximum globe holder(s).

**Weight:** 6.5Kg **Width:** 290mm **Depth:** 290mm

**Height:** 875mm + **Suspension:** 1000mm oval chain



### FL-PD1065-3C

Traditional rustic bronze ceiling float lamp, with diamond cut glass.

**Wiring:** 3x B15 (SBC), 60 watt maximum globe holder(s).

**Weight:** 4.9Kg **Width:** 255mm **Depth:** 255mm  
**Height:** 390mm + **Suspension:** 1000mm oval chain.

Larger size also available (**PD1065-3CL**).

**Weight:** 6.3Kg **Width:** 330mm

**Depth:** 330mm

**Height:** 440mm + **Suspension:** 1000mm oval chain.



### FL-PD1068S

Large French provincial styled rustic bronze ceiling float lamp. With seeded clear glass. Available with plain clear glass (FL PD1068P).

**Wiring:** 4x B15 (SBC), 60 watt maximum globe holder(s).

**Weight:** 6.5Kg **Width:** 475mm **Depth:** 475mm

**Height:** 760mm + **Suspension:** 1000mm oval chain



### FL-PD137

Côte d'Azur style medium bright chrome ceiling float lamp. With chrome finial, band and chain cap and wide ribbed clear glass.

**Wiring:** 4x E14 (SES), 60 watt maximum globe holder(s).

**Weight:** 6.0Kg **Width:** 300mm **Depth:** 300mm

**Height:** 600mm + **Suspension:** 1000mm oval chain



### FL-PD137XL

Côte d'Azur style X-Large bright chrome ceiling float lamp. With chrome finial, band and chain cap and wide ribbed clear glass.

**Wiring:** 4x E14 (SES), 60 watt maximum globe holder(s).

**Weight:** 10.0Kg **Width:** 400mm **Depth:** 400mm

**Height:** 900mm + **Suspension:** 1000mm oval chain

## FL1-G

One light hundi ceiling float lamp shown in polished brass with grape glass.  
Hand finished in either polished brass (-PB), old brass (-OB), black bronze (-BB), antique bronze (-AB), antique nickel (-AN), bright chrome (-BC), or powder coated (-PC).  
Available with plain glass (FL1-P) and fern glass (FL1-F).

**Wiring:** 1x B22 (BC), 60 watt maximum globe holder(s).

**Weight:** 4.9Kg **Width:** 200mm **Depth:** 200mm  
**Height:** 390mm + **Suspension:** 12.700 x 750mm



## FL3M-G

Medium hundi ceiling float lamp shown in polished brass with grape glass.  
Hand finished in either polished brass (-PB), old brass (-OB), black bronze (-BB), antique bronze (-AB), antique nickel (-AN), bright chrome (-BC), or powder coated (-PC).  
Available with plain glass (FL3M-P) or diamond cut glass (FL3M-D).

**Wiring:** 3x B15 (SBC), 60 watt maximum globe holder(s).

**Weight:** 7.6Kg **Width:** 305mm **Depth:** 305mm  
**Height:** 570mm + **Suspension:** 12.700 x 750mm



## FL3S-D

Small hundi ceiling float lamp shown in antique bronze with diamond cut glass.  
Hand finished in either polished brass (-PB), old brass (-OB), black bronze (-BB), antique bronze (-AB), antique nickel (-AN), bright chrome (-BC), or powder coated (-PC).  
Available with plain glass (FL3S-P) or grape glass (FL3S-G).

**Wiring:** 3x B15 (SBC), 60 watt maximum globe holder(s).

**Weight:** 6.5Kg **Width:** 255mm **Depth:** 255mm  
**Height:** 470mm + **Suspension:** 12.700 x 750mm

## FL3L-P

Large hundi ceiling float lamp shown in antique nickel with plain glass.  
Hand finished in either polished brass (-PB), black bronze (-BB), antique nickel (-AN), or bright chrome (-BC).  
Available with grape glass (FL3L-G).

**Wiring:** 3x B15 (SBC), 60 watt maximum globe holder(s).

**Weight:** 9.7Kg **Width:** 400mm **Depth:** 400mm  
**Height:** 875mm + **Suspension:** 15.875 x 750mm





## Ceiling - Lanterns

At Robert Kitto, we are aware of the popularity that lanterns have gathered over time, and our range of specially made lanterns, with innovative designs are sure to satisfy.

Ranging from more traditional Georgian period brass lanterns to modern chrome, black or bronze tapered lanterns, our range created with durable materials, provides a unique mix of old school classic style and modern chic. This allows for unique finishings whilst providing optimal illumination and visibility for a room or space.

Featured from our old classic designs are the inimitable square and hexagonal Charles and Elizabeth Lanterns with your choice of etched, cut or beveled glass exterior. All held within our unique durable double edged cut frame, these designs are proven, and built to last.

For a unique rounded lantern look, our Bevington or St George range could be perfect for your space.

All of our Traditional lanterns come in a variety of finishes including brass, bronze and nickel to suit any type of area. Many of our classic models also come with

three or five-light fitting capabilities for additional visibility to brighten larger rooms.

For something more innovative and modern, our Frustum style collection of lanterns come with trapezoidal glass, with a noticeable taper from bottom to top displaying a more modern approach to this traditional style of fixture.

Robert Kitto Lighting strives to provide you with an extensive quality and customisable range of lanterns.

Modified Charles Large Hexagonal Lantern, photographed in Adelaide's Chinatown, Property of Adelaide City Council,



#### HL-PD0074P-4

Stunning Bright Chrome diamond shaped ceiling lantern with glass door for access to change the four globes.

**Wiring:** 4x E14 (SES), 60 watt maximum globe holder(s).

**Weight:** 7.3Kg  
**Width:** 380mm **Depth:** 380mm  
**Height:** 800mm + **Suspension:** 1000mm chain

#### HL-PD0112P-4

Traditional Georgian style ceiling lantern in black with glass door to change the four globes.

**Wiring:** 4x E14 (SES), 60 watt maximum globe holder(s).

**Weight:** 7.3Kg **Width:** 380mm **Depth:** 380mm  
**Height:** 800mm + **Suspension:** 1000mm chain





### HL-PD0113P-3

French provincial style black round ceiling lantern.

**Wiring:** 3x E14 (SES), 60 watt maximum globe holder(s).

**Weight:** 4.3Kg

**Width:** 350mm

**Depth:** 350mm

**Height:** 620mm + **Suspension:** 1000mm chain



### HL-PD0115P-4M

Brilliant spherical shaped ceiling lantern in antique brass with glass door to change the four globes.

**Wiring:** 4x E14 (SES), 60 watt maximum globe holder(s).

**Weight:** 7.3Kg

**Width:** 430mm

**Depth:** 430mm

**Height:** 630mm + **Suspension:** 1000mm chain

### HL-PD0118P-4

Brilliant egg shaped ceiling lantern in antique brass with glass door for globe access.

**Wiring:** 4x E14 (SES), 60 watt maximum globe holder(s).

**Weight:** 7.3Kg

**Width:** 360mm

**Depth:** 360mm

**Height:** 800mm + **Suspension:** 1000mm chain



### HL-PD6037-3-BC

Stylish spherical ceiling lantern in bright chrome with three arms and opal glass cylinders inside.

**Wiring:** 3x E27 (ES), 60 watt maximum globe holder(s).

**Weight:** 7.3Kg

**Width:** 495mm **Depth:** 495mm

**Height:** 540mm +

**Suspension:** 1000mm oval chain



Also available in a four light larger sized frame (HL-PD6037-4-BC).

**Wiring:** 4x E27 (ES), 60 watt maximum globe holder(s).

**Weight:** 11.1Kg

**Width:** 795mm **Depth:** 795mm

**Height:** 800mm + **Suspension:** 1000mm oval chain



### HL-115

Tapered bright nickel ceiling lantern with four pieces of clear glass and a traditional styled hinged door for globe access.

**Wiring:** 3x E14 (SES), 60 watt maximum globe holder(s).

**Width:** 290mm **Depth:** 290mm

**Height:** 640mm + **Suspension:** 1000mm C9 chain



### HL-118

Square ceiling lantern with four pieces of plain clear glass and a traditional styled hinged door for globe access. Shown in antique silver (-AS), also available in polished brass (-PB) and antique brass (-AB).

**Wiring:** 3x E14 (SES), 60 watt maximum globe holder(s).

**Width:** 290mm **Depth:** 290mm

**Height:** 640mm + **Suspension:** 1000mm C9 chain



### HL-119

Square ceiling lantern with four pieces of plain clear glass and a traditional styled hinged door for globe access. Shown in antique silver (-AS), also available in polished brass (-PB) and antique brass (-AB).

**Wiring:** 1x B22 (BC), 60 watt maximum globe holder(s).

**Width:** 260mm **Depth:** 260mm

**Height:** 450mm + **Suspension:** 1000mm C9 chain



### HL-120

Aintree round antique silver ceiling lantern with four pieces of curved clear glass and a traditional styled hinged door for globe access.

**Wiring:** 4x E14 (SES), 60 watt maximum globe holder(s).

**Width:** 290mm **Depth:** 290mm

**Height:** 630mm + **Suspension:** 1000mm C9 chain



**HL-123**

Narrow pointed six sided bronze ceiling lantern with twelve pieces of curved clear glass with door for globe access.

**Wiring:** 1x B22 (BC), 60 watt maximum globe holder(s).

**Weight:** 6.0Kg **Width:** 300mm **Depth:** 300mm  
**Height:** 700mm + **Suspension:** 1000mm C9 chain

**HL-125**

Arlington spherical bronze ceiling lantern with ten pieces of curved clear glass with door for globe access.

**Wiring:** 4x E14 (SES), 60 watt maximum globe holder(s).

**Width:** 410mm **Depth:** 410mm  
**Height:** 700mm + **Suspension:** 1000mm C8 chain



**HL-1136-4M**

Decorative square bronze ceiling lantern with clear glass.

**Wiring:** 4x B15 (SBC), 60 watt maximum globe holder(s).

**Weight:** 4.8Kg **Width:** 300mm **Depth:** 300mm  
**Height:** 700mm + **Suspension:** 1000mm oval chain

Available in a smaller size (HL-1136-4S).

**Weight:** 3.9Kg **Width:** 230mm **Depth:** 230mm  
**Height:** 590mm + **Suspension:** 1000mm oval chain

Available in a larger size (HL-1136-4L).

**Weight:** 6.3Kg **Width:** 325mm **Depth:** 325mm  
**Height:** 860mm + **Suspension:** 1000mm oval chain



**HL-191-BC**

Grosvenor ceiling lantern shown in blackened copper with clear glass with door for globe access. Also available in bright nickel (HL-191-BN).

**Wiring:** 3x E14 (SES), 60 watt maximum globe holder(s).

**Weight:** 4.8Kg **Width:** 300mm **Depth:** 300mm  
**Height:** 830mm + **Suspension:** 750mm C8 chain



### HL-873-BZ

Decorative round black bronze ceiling lantern with clear glass.

**Wiring:** 4x B15 (SBC), 60 watt maximum globe holder(s).

**Weight:** 4.8Kg **Width:** 280mm **Depth:** 280mm  
**Height:** 560mm + **Suspension:** 1000mm oval chain



### HL-PD1074-3-BZ

Small round bronze ceiling lantern with plain clear glass.

**Wiring:** 3x B15 (SBC), 60 watt maximum globe holder(s).

**Weight:** 3.5Kg **Width:** 200mm **Depth:** 200mm  
**Height:** 380mm + **Suspension:** 750mm oval chain

Also available with diamond cut glass (HL-PD1074-3A-BZ).

### HL-PD3302P-BC

Modern round bright chrome ceiling lantern with plain clear glass. Also available with diamond cut glass (HL-PD3302D-BC).

**Wiring:** 3x E14 (SES), 60 watt maximum globe holder(s).

**Weight:** 3.5Kg **Width:** 200mm **Depth:** 200mm  
**Height:** 380mm + **Suspension:** 1000mm oval chain



### HL-PD3305P-BC

Modern round bright chrome ceiling lantern with plain clear glass.

**Wiring:** 4x B15 (SBC), 60 watt maximum globe holder(s).

**Weight:** 6.4Kg **Width:** 320mm **Depth:** 320mm  
**Height:** 600mm + **Suspension:** 1000mm oval chain



### HL-PD3304P-BC

Modern round ceiling lantern shown in bright chrome with plain clear glass and 4x **VIN-LED-C35T-E14** (globes, separate items). Also available with fluted glass (HL-PD3304F), or diamond cut glass (HL-PD3304D). Hand finished in bright chrome (-BC), or bronze (-BZ).

**Wiring:** 4x E14 (SES), 60 watt maximum globe holder(s).

**Weight:** 4.2Kg **Width:** 280mm **Depth:** 280mm  
**Height:** 430mm + **Suspension:** 1000mm oval chain



### HL-PD3304P-BZ

Modern round ceiling lantern shown in bronze with plain clear glass and 4x **VIN-LED-C35T-E14** (globes, separate items). Also available with fluted glass (HL-PD3304F), or diamond cut glass (HL-PD3304D). Hand finished in bright chrome (-BC), or bronze (-BZ).

**Wiring:** 4x E14 (SES), 60 watt maximum globe holder(s).

**Weight:** 4.2Kg **Width:** 280mm **Depth:** 280mm  
**Height:** 430mm + **Suspension:** 1000mm oval chain



### HL-PD3304F-BC

Modern round ceiling lantern shown in bright chrome with fluted glass. Also available with plain clear glass (HL-PD3304P) or diamond cut glass (HL-PD3304D). Hand finished in bright chrome (-BC), or bronze (-BZ).

**Wiring:** 4x E14 (SES), 60 watt maximum globe holder(s).

**Weight:** 4.2Kg **Width:** 280mm **Depth:** 280mm  
**Height:** 430mm + **Suspension:** 1000mm oval chain



### HL-PD3306P-BC

Modern round bright chrome ceiling lantern with plain clear glass. Also available in fluted glass (HL-PD3306F-BC).

**Wiring:** 4x E14 (SES), 60 watt maximum globe holder(s).

**Weight:** 8.5Kg **Width:** 440mm **Depth:** 440mm  
**Height:** 690mm + **Suspension:** 1000mm oval chain







### HL-PD9003-SN

Modern square satin nickel ceiling lantern with bevelled glass.

**Wiring:** 3x E14 (SES), 60 watt maximum globe holder(s).

**Weight:** 3.3Kg **Width:** 270mm **Depth:** 270mm  
**Height:** 475mm + **Suspension:** 1000mm oval chain



### HL-PD9003-BZ

Modern square black bronze ceiling lantern with bevelled glass.

**Wiring:** 3x E14 (SES), 60 watt maximum globe holder(s).

**Weight:** 3.3Kg **Width:** 270mm **Depth:** 270mm  
**Height:** 475mm + **Suspension:** 1000mm oval chain



### HL-PD9015-3-BC

Stylish bright chrome ceiling lantern with eight pieces of bevelled trapezoidal clear glass. Shown with 3x **VIN-LED-C35-E14** (globes, separate item).

**Wiring:** 3x E14 (SES), 60 watt maximum globe holder(s).

**Weight:** 3.9Kg **Width:** 290mm **Depth:** 290mm  
**Height:** 530mm + **Suspension:** 1000mm oval chain



### HL-PD9015-3-BZ

Stylish black bronze ceiling lantern with eight pieces of bevelled trapezoidal clear glass. Shown with 3x **VIN-LED-C35-E14** (globes, separate item).

**Wiring:** 3x E14 (SES), 60 watt maximum globe holder(s).

**Weight:** 3.9Kg **Width:** 290mm **Depth:** 290mm  
**Height:** 530mm + **Suspension:** 1000mm oval chain





### HL-PD9015-4-BZ

Stylish black bronze ceiling lantern with eight pieces of bevelled trapezoidal clear glass. Shown with 4x **VIN-LED-C35-E14** (globes, separate item).

**Wiring:** 4x E14 (SES), 60 watt maximum globe holder(s).

**Weight:** 6.5Kg **Width:** 430mm **Depth:** 430mm  
**Height:** 595mm + **Suspension:** 1000mm oval chain



### HL-PD9015-4-BC

Stylish bright chrome ceiling lantern with eight pieces of bevelled trapezoidal clear glass. Shown with 4x **VIN-LED-C35-E14** (globes, separate item).

**Wiring:** 4x E14 (SES), 60 watt maximum globe holder(s).

**Weight:** 6.5Kg **Width:** 430mm **Depth:** 430mm  
**Height:** 595mm + **Suspension:** 1000mm oval chain



### HL-F10-SN

Contemporary square frustum satin nickel ceiling lantern with bevelled glass. Shown with 1x VIN-T45-40-ES (globe, separate item).

**Wiring:** 1x E27 (ES), 60 watt maximum globe holder(s).

**Weight:** 3.9Kg **Width:** 275mm **Depth:** 275mm  
**Height:** 280mm + **Suspension:** 1000mm oval chain



### HL-F11-SN

Contemporary square frustum satin nickel ceiling lantern with clear glass. Shown with 1x VIN-ST64-60-ES (globe, separate item).

**Wiring:** 1x E27 (ES), 60 watt maximum globe holder(s).

**Weight:** 5.7Kg **Width:** 400mm **Depth:** 400mm  
**Height:** 400mm + **Suspension:** 1000mm oval chain



### HL-F11-BZ

Contemporary square frustum black bronze ceiling lantern with clear glass. Shown with 1x VIN-ST64-60-ES (globe, separate item).

**Wiring:** 1x E27 (ES), 60 watt maximum globe holder(s).

**Weight:** 5.7Kg **Width:** 400mm **Depth:** 400mm  
**Height:** 400mm + **Suspension:** 1000mm oval chain



### HL-F10-BZ

Contemporary square frustum black bronze ceiling lantern with bevelled glass. Shown with 1x VIN-T45-40-ES (globe, separate item).

**Wiring:** 1x E27 (ES), 60 watt maximum globe holder(s).

**Weight:** 3.9Kg **Width:** 275mm **Depth:** 275mm  
**Height:** 280mm + **Suspension:** 1000mm oval chain



### HL-F28-SN

Contemporary round frustum satin nickel ceiling lantern with clear glass.  
Shown with 1x VIN-ST64-60-ES (globe, separate item)

**Wiring:** 1x E27 (ES), 60 watt maximum globe holder(s).

**Weight:** 3.9Kg **Width:** 280mm **Depth:** 280mm  
**Height:** 280mm + **Suspension:** 1000mm oval chain



### HL-F28-BZ

Contemporary round frustum black bronze ceiling lantern with clear glass.  
Shown with 1x VIN-ST64-60-ES (globe, separate item).

**Wiring:** 1x E27 (ES), 60 watt maximum globe holder(s).

**Weight:** 3.9Kg **Width:** 280mm **Depth:** 280mm  
**Height:** 280mm + **Suspension:** 1000mm oval chain



### HL-F40-SN

Contemporary round frustum satin nickel ceiling lantern with clear glass. Shown with 3x VIN-ST64-60-ES (globes, separate item).

**Wiring:** 3x E27 (ES), 60 watt maximum globe holder(s).

**Weight:** 5.7Kg **Width:** 400mm **Depth:** 400mm  
**Height:** 400mm + **Suspension:** 1000mm oval chain



### HL-F40-BZ

Contemporary round frustum black bronze ceiling lantern with clear glass.  
Shown with 3x VIN-ST64-60-ES (globes, separate item).

**Wiring:** 3x E27 (ES), 60 watt maximum globe holder(s).

**Weight:** 5.7Kg **Width:** 400mm **Depth:** 400mm  
**Height:** 400mm + **Suspension:** 1000mm oval chain



### HL-F40-AB

Contemporary round frustum antique brass ceiling lantern with clear glass. Shown with 3x VIN-ST64-60-ES (globes, separate item).

**Wiring:** 3x E27 (ES), 60 watt maximum globe holder(s).

**Weight:** 5.7Kg **Width:** 400mm **Depth:** 400mm  
**Height:** 400mm + **Suspension:** 1000mm oval chain



### HL-PD1150

Matt black hexagonal ceiling lantern with bevelled glass.

**Wiring:** 3x B15 (SBC), 60 watt maximum globe holder(s).

**Weight:** 3.9Kg **Width:** 330mm **Depth:** 330mm  
**Height:** 800mm + **Suspension:** 1000mm oval chain

Also shown with bottom arms removed for a more minimal appearance.

**Height:** 590mm



### HL-F28-AB

Contemporary round frustum antique brass ceiling lantern with clear glass. Shown with 1x VIN-ST64-60-ES (globe, separate item).

**Wiring:** 1x E27 (ES), 60 watt maximum globe holder(s).

**Weight:** 3.9Kg **Width:** 280mm **Depth:** 280mm  
**Height:** 280mm + **Suspension:** 1000mm oval chain



### HLXS-GB

Charles small hexagonal ceiling lantern shown in polished brass with bevelled glass and cream candle covers. Hand finished in either polished brass (-PB), old brass (-OB), black bronze (-BB), antique bronze (-AB), antique nickel (-AN), bright chrome (-BC) or powder coated (-PC).

**Wiring:** 3x E14 (SES), 60 watt maximum globe holder(s) .

**Weight:** 9.0Kg **Width:** 315mm **Depth:** 315mm  
**Height:** 540mm + **Suspension:** 12.700 x 750mm

-AN, -BC and -PC finishes come with cream candle covers.



### HLXM-GB

Charles medium hexagonal ceiling lantern shown in antique nickel with bevelled glass and white candle covers. Hand finished in either polished brass (-PB), old brass (-OB), black bronze (-BB), antique bronze (-AB), antique nickel (-AN), bright chrome (-BC) or powder coated (-PC)

**Wiring:** 3x E14 (SES), 60 watt maximum globe holder(s).

**Weight:** 14.5Kg **Width:** 420mm **Depth:** 420mm  
**Height:** 620mm + **Suspension:** 15.875 x 750mm

-PB, -OB, -BB and -AB finishes come with cream candle covers.

### HLXL-GB

Charles large hexagonal ceiling lantern shown in antique bronze with bevelled glass and cream candle covers. Hand finished in either polished brass (-PB), old brass (-OB), black bronze (-BB), antique bronze (-AB), antique nickel (-AN), bright chrome (-BC) or powder coated (-PC).

**Wiring:** 3x E14 (SES), 60 watt maximum globe holder(s).

**Weight:** 19.5Kg **Width:** 480mm **Depth:** 480mm  
**Height:** 760mm + **Suspension:** 19.050 x 750mm  
-AN, -BC and -PC finishes come with white candle covers.



### HL-GE

Charles square ceiling lantern shown in polished brass with etched glass. Hand finished in either polished brass (-PB), old brass (-OB), black bronze (-BB), antique bronze (-AB), antique nickel (-AN), bright chrome (-BC), or powder coated (-PC).

**Wiring:** 1x B22 (BC), 60 watt maximum globe holder(s).

**Weight:** 6.1Kg **Width:** 210mm **Depth:** 210mm  
**Height:** 405mm + **Suspension:** 12.700 x 750mm

Also available with cut glass (HL-GC) or with beveled glass (HL-GB).

-AN, -BC and -PC finishes come with white candle covers



### HL3-GB

Charles three light square ceiling lantern shown in polished brass with bevelled glass. Hand finished in either polished brass (-PB), old brass (-OB), black bronze (-BB), antique bronze (-AB), antique nickel (-AN), bright chrome (-BC), or powder coated (-PC).

**Wiring:** 3x E14 (SES), 60 watt maximum globe holder(s).

**Weight:** 6.7Kg  
**Width:** 210mm  
**Depth:** 210mm  
**Height:** 405mm +  
**Suspension:** 12.700 x 750mm

Also available with cut glass (HL3-GC) or with etched glass (HL3-GE).

-AN, -BC and -PC finishes come with white candle covers



### HLB-GB

Charles tall square ceiling lantern shown in polished brass with bevelled glass. Hand finished in either polished brass (-PB), old brass (-OB), black bronze (-BB), antique bronze (-AB), antique nickel (-AN), bright chrome (-BC), or powder coated (-PC).

**Wiring:** 3x E14 (SES), 60 watt maximum globe holder(s).

-AN, -BC and -PC finishes come with white candle covers.

### HLL-GB

Charles square ceiling lantern shown in polished brass with bevelled glass. Hand finished in either polished brass (-PB), old brass (-OB), black bronze (-BB), antique bronze (-AB), antique nickel (-AN), bright chrome (-BC), or powder coated (-PC).

**Wiring:** 3x E14 (SES), 60 watt maximum globe holder(s).

**Weight:** 9.4Kg **Width:** 300mm **Depth:** 300mm  
**Height:** 630mm +  
**Suspension:** 19.050 x 750mm

-AN, -BC and -PC finishes come with white candle covers.



### HLS82

Small Washington pentagonal ceiling lantern with tapered clear glass shown in polished brass. Hand finished in either polished brass (-PB), black bronze (-BB), or bright chrome (-BC).

**Wiring:** 1x B22 (BC), 60 watt maximum globe holder(s).

**Weight:** 4.8Kg **Width:** 220mm **Depth:** 220mm  
**Height:** 330mm + **Suspension:** 1000mm C8 chain



### HLLC-GB

Alfred square ceiling lantern shown in antique bronze with bevelled glass. Hand finished in either polished brass (-PB), black bronze (-BB), antique bronze (-AB), antique nickel (-AN), or bright chrome (-BC).

**Wiring:** 3x E14 (SES), 60 watt maximum globe holder(s).

**Weight:** 8.8Kg **Width:** 300mm **Depth:** 300mm  
**Height:** 630mm + **Suspension:** 1000mm C8 chain

Also available in a larger model (HLLLC-GB).

**Weight:** 11.9Kg **Width:** 400mm **Depth:** 400mm  
**Height:** 750mm

-AN and -BC finishes come with white candle covers.





### HL-F300-MB

Powder coated (matt black) aluminium square ceiling lantern, complete with bevelled glass.

**Wiring:** 1x B22 (BC), 60 watt maximum globe holder(s).

**Weight:** 6.3Kg **Width:** 300mm **Depth:** 300mm  
**Height:** 380mm + **Suspension:** 1000mm C8 Chain



### HL-F300-PA

Polished aluminium square ceiling lantern, complete with bevelled glass.

**Wiring:** 1x B22 (BC), 60 watt maximum globe holder(s).

**Weight:** 6.3Kg **Width:** 300mm **Depth:** 300mm  
**Height:** 380mm + **Suspension:** 1000mm C8 Chain



### HL460

Large Bevington round ceiling lantern shown in antique bronze. Hand finished in either polished brass (-PB), old brass (-OB), black bronze (-BB), antique bronze (-AB), antique nickel (-AN), bright chrome (-BC), or powder coated (-PC).

**Wiring:** 3x E14 (SES), 60 watt maximum globe holder(s).

**Weight:** 15.0Kg **Width:** 460mm **Depth:** 460mm  
**Height:** 800mm + **Suspension:** 15.875 x 750mm

### HL260

Small Bevington round ceiling lantern shown in polished brass. Hand finished in either polished brass (-PB), old brass (-OB), black bronze (-BB), antique bronze (-AB), antique nickel (-AN), bright chrome (-BC), or powder coated (-PC).

**Wiring:** 3x E14 (SES), 60 watt maximum globe holder(s).

**Weight:** 9.0Kg **Width:** 260mm **Depth:** 260mm  
**Height:** 530mm + **Suspension:** 15.875 x 750mm





### HLS1004

Small St George round ceiling lantern shown in old brass. Hand finished in either polished brass (-PB), old brass (-OB), black bronze (-BB), antique bronze (-AB), antique nickel (-AN), bright chrome (-BC), bright nickel (-BN), or powder coated (-PC).

**Wiring:** 3x B15 (SBC), 60 watt maximum globe holder(s).

**Weight:** 7.6Kg **Width:** 190mm **Depth:** 190mm  
**Height:** 400mm + **Suspension:** 12.700 x 750mm



### HLS1008

Large St George round ceiling lantern shown in bright chrome with white candle covers. Hand finished in either polished brass (-PB), old brass (-OB), black bronze (-BB), antique bronze (-AB), antique nickel (-AN), bright chrome (-BC), bright nickel (-BN), or powder coated (-PC).

**Wiring:** 6x E14 (SES), 60 watt maximum globe holder(s).

**Weight:** 24.2Kg **Width:** 625mm **Depth:** 625mm  
**Height:** 1195mm + **Suspension:** 500mm C8

-PB, -OB, BB and -AB finishes have cream candle covers.



### HLS1005

Medium St George round hanging lantern shown in old brass with cream candle covers.

Hand finished in either polished brass (-PB), old brass (-OB), black bronze (-BB), antique bronze (-AB), antique nickel (-AN), bright chrome (-BC), bright nickel (-BN), or powder coated (-PC).

**Wiring:** 3x E14 (SES), 60 watt maximum globe holder(s).

**Weight:** 14.1Kg **Width:** 340mm **Depth:** 340mm  
**Height:** 530mm + **Suspension:** 500mm C8

-AN, -BN, BC and -PC finishes have white candle covers.



# Ceiling - Pendants

Pendant lights give elegant and sophisticated illumination, which can be perfect for providing style and finesse to your rooms. As a popular option for both small and large rooms, pendant lights come in a range of forms and sizes, and can add a depth of character to your room. Robert Kitto have an extensive selection of hanging pendant lights that give you the freedom to experiment and get creative in your space. From smaller two or three-light hanging models, to sophisticated and elaborate chandeliers, our extensive range of pendant lights provide a comprehensive assortment of lighting options, sure to fit with any desired requirements or appearance.

Beyond form, our pendant fixtures can be finished in a number of effects, from a traditional style with polished brass or an old brass finish to add a refined, aged effect. For a more modern appearance, a bronze or chrome finish may fit best with your décor. For something timeless and minimal, see our tried and tested Gloucester or Magill series of pendant lights. These two or three-light pendant models are both basic old school designs, often completed with simple glass or metal shades. In contrast, the P10 Ascot, Albert and Flemington lights are regal, classy designs, perfect to match these styles of décor.

For larger areas, and a more opulent look, browse our range of chandeliers. Able to house a large number of lights, our chandeliers are built to last, featuring old, traditional and basket-style designs to lavishly brighten your home.

The latest in pendant lights from Robert Kitto are the Brooklyn and Staten range, featuring contemporary and intriguing designs. These lights are available in polished brass or bright chrome finishes or, for a more reserved feel, they can be finished in old brass or powder coated in matt black.

For more simple singular light fittings see our ceiling suspensions which provide good lighting and appeal, whilst occupying less space than other, more elaborate, pendant lights in our range. In addition to your choice of colour, the fitting and shade are separate, and often independent of each other, allowing increased freedom to pick the metal or glass shade to perfectly match your fitting.

No matter your pendant light preference, the extensive range and customisation from Robert Kitto is sure to have the perfect fittings for you and your home.



Four Light Staten Pendant, photographed at The Parkside Hotel, in Adelaide, South Australia.



Twin Wall Light also available, see page 81.



READY TO SHIP

**PD2978-3**

Three light plumbing pendant, available only in galvanized bronze. Shown with 3x VIN-ST64-E27 vintage globes.

**Wiring:** 3x E27 (ES), 60 watt maximum globe holder(s).

**Weight:** 2.0Kg **Width:** 600mm **Depth:** 55mm  
**Height:** 150mm + **Suspension:** Variable (4x extension rods) max 1150mm

*Globes not included but readily available*

**PD2978-5**

Five light plumbing pendant, available only in galvanized bronze. Shown with 5x VIN-ST64-E27 vintage globes.

**Wiring:** 3x E27 (ES), 60 watt maximum globe holder(s).

**Weight:** 2.0Kg **Width:** 840mm **Depth:** 55mm  
**Height:** 150mm + **Suspension:** 2x 1M lengths of chain



READY TO SHIP

*Globes not included but readily available*

Single Wall Light also available, see page 81.





### CH-O240

240mm Egyptian lead crystal basket chandelier pendant shown in nickel. Select your finish from brass (-BRASS), bronze (-BRONZE) or nickel (-NICKEL).

**Wiring:** 1x B22 (BC), 60 watt maximum globe holder(s).

**Width:** 240mm **Depth:** 240mm

**Height:** 700mm + **Suspension:** 1000mm C9 oval link chain.



### CH-O400

400mm Egyptian lead crystal basket chandelier pendant shown in bronze. Select your finish from brass (-BRASS), bronze (-BRONZE) or nickel (-NICKEL).

**Wiring:** 4x B22 (BC), 60 watt maximum globe holder(s).

Optional (Shown): 6x B22 (BC), 60 watt maximum globe holder(s).

**Width:** 400mm **Depth:** 400mm

**Height:** 700mm + **Suspension:** 1000mm C8 heavy link chain.



### CH-O600

600mm Egyptian lead crystal basket chandelier pendant shown in nickel. Select your finish from brass (-BRASS), bronze (-BRONZE) or nickel (-NICKEL).

**Wiring:** 6x B22 (BC), 60 watt maximum globe holder(s).

**Width:** 600mm **Depth:** 600mm

**Height:** 1050mm + **Suspension:** 1000mm C8 heavy link chain.



### CH-599181C

500mm K9 lead crystal stepped basket chome chandelier pendant.

**Wiring:** 12x E14 (SES), 60 watt maximum globe holder(s).

**Width:** 500mm **Depth:** 500mm  
**Height:** 750mm + **Suspension:** 1000mm C8 heavy link chain.



### CH-SS1118

500mm K9 lead crystal French style antique brass chandelier pendant.

**Wiring:** 12x E14 (SES), 60 watt maximum globe holder(s).

**Width:** 800mm **Depth:** 800mm  
**Height:** 1000mm + **Suspension:** 1000mm C8 heavy link chain.

In South Australia this product is exclusively available from Mitcham Antique Gallery



### CH-1018-6

Rustic Bronze chandelier frame decorated with Egyptian lead crystals.

**Wiring:** 6x B15 (SBC), 40 watt maximum globe holder(s).

**Weight:** 6.0Kg **Width:** 650mm **Depth:** 650mm  
**Height:** 850mm + **Suspension:** 1000mm



### P7H132-5

Five arm Netherby pendant shown in old brass with cream candle covers. Hand finished in either polished brass (-PB), old brass (-OB), black bronze (-BB), antique bronze (-AB), antique nickel (-AN), bright chrome (-BC), or powder coated (-PC).

**Wiring:** 5x E14 (SES), 60 watt maximum globe holder(s).

**Width:** 380mm **Depth:** 380mm  
**Height:** 130mm + **Suspension:** 12.7mm x 500mm

-AN, -BC and -PC finishes are made with white candle covers.

### P12U68-5

Five arm Northgate pendant shown in antique nickel with white candle covers and 5x **S901P** glass shades. Hand finished in either polished brass (-PB), black bronze (-BB), antique nickel (-AN), bright chrome (-BC).

**Wiring:** 5x E14 (SES), 40 watt maximum globe holder(s).

**Width:** 850mm **Depth:** 850mm  
**Height:** 610mm + **Suspension:** 1000mm C7-04 chain

-PB and -BB finishes are made with cream candle covers.



### P6FL-5

Five arm Edward pendant shown in polished brass with cream candle covers. Hand finished in either polished brass (-PB), old brass (-OB), black bronze (-BB), antique bronze (-AB), antique nickel (-AN), bright chrome (-BC).

**Wiring:** 5x E14 (SES), 40 watt maximum globe holder(s).

**Weight:** 6.2Kg **Width:** 500mm **Depth:** 500mm  
**Height:** 300mm + **Suspension:** 1000mm C3 decorative chain

-AN and -BC finishes are made with white candle covers.



### P10FL-7

Seven arm William pendant shown in polished brass with cream candle covers. Hand finished in either polished brass (-PB), old brass (-OB), black bronze (-BB), antique bronze (-AB), antique nickel (-AN), bright chrome (-BC), or powder coated (-PC).

**Wiring:** 7x E14 (SES), 40 watt maximum globe holder(s).

**Width:** 800mm **Depth:** 800mm  
**Height:** 370mm + **Suspension:** 1000mm  
C3 decorative chain

-AN, -BC and -PC finishes are made with white candle covers.



### P1FL-3CRS

Three arm Dover pendant shown in old brass with cream candle covers, complete with Egyptian lead crystal cups and drops. Hand finished in either polished brass (-PB), old brass (-OB), black bronze (-BB), antique bronze (-AB), antique nickel (-AN), bright nickel (-BN), bright chrome (-BC), or powder coated (-PC).

**Wiring:** 3x E14 (SES), 40 watt maximum globe holder(s).

**Weight:** 5.3Kg **Width:** 500mm **Depth:** 500mm  
**Height:** 300mm + **Suspension:** 1000mm C7-04 oval link chain

-AN, -BN, -BC and -PC finishes are made with white candle covers.



### P10FL-9

Nine arm William pendant shown in polished brass with cream candle covers.

Hand finished in either polished brass (-PB), old brass (-OB), black bronze (-BB), antique bronze (-AB), antique nickel (-AN), bright chrome (-BC) or powder coated (-PC).

**Wiring:** 9x E14 (SES), 40 watt maximum globe holder(s).

**Width:** 800mm **Depth:** 800mm  
**Height:** 520mm + **Suspension:** 1000mm  
C3 decorative chain

-AN, -BC and -PC finishes are made with white candle covers.





### P7T2-2

Two arm Chatham pendant shown in satin nickel with two **S1020-OG** glass shades. Hand finished in either polished brass (-PB), old brass (-OB), black bronze (-BB), antique bronze (-AB), antique nickel (-AN), satin nickel (-SN), bright chrome (-BC) or powder coated (-PC).

**Wiring:** 2x B22 (BC), 60 watt maximum globe holder(s).

**Width:** 465mm **Depth:** 465mm

**Height:** 100mm + **Suspension:** 12.7mm x 750mm

### P7T2-3G4GS

Three arm Clarendon pendant with 3x integrated **G4GS** galleries, shown in antique nickel with three **S605** glass shades. Hand finished in either polished brass (-PB), old brass (-OB), black bronze (-BB), antique bronze (-AB), antique nickel (-AN), bright chrome (-BC) or powder coated (-PC).

**Wiring:** 3x B22 (BC), 60 watt maximum globe holder(s).

**Width:** 465mm **Depth:** 465mm

**Height:** 120mm + **Suspension:** 12.7mm x 750mm



### P7T2-3DDC

Three arm Clarendon pendant with integrated decorative cups, shown in polished brass with three **S4745** glass shades. Hand finished in either polished brass (-PB), old brass (-OB), black bronze (-BB), antique bronze (-AB), antique nickel (-AN), bright chrome (-BC), or powder coated (-PC).

**Wiring:** 3x B22 (BC), 60 watt maximum globe holder(s).

**Width:** 465mm

**Depth:** 465mm

**Height:** 100mm +

**Suspension:** 12.7mm x 750mm



### P-BROOKLYN-10L

Brooklyn ten light long arm pendant shown in old brass with 10x **VIN-LED-G125-B22** globes. Hand finished in either polished brass (-PB), old brass (-OB), black bronze (-BB), antique bronze (-AB), antique nickel (-AN), bright chrome (-BC) or powder coated (-PC).

**Wiring:** 10x B22 (BC), 60 watt maximum globe holder(s).

**Width:** 1150mm **Depth:** 1150mm

**Height:** 575mm + **Suspension:** 12.7mm x 750mm

Also available as a Staten ten light, with integrated G3DS galleries (**P-STATEN-10L**).



### P-STATEN-6L

Staten six light long arm pendant with 6x integrated **G3DS** galleries shown in bright chrome with 6x **SPH150-OG** glass shades. Hand finished in either polished brass (-PB), old brass (-OB), black bronze (-BB), antique bronze (-AB), antique nickel (-AN), bright chrome (-BC) or powder coated (-PC).

**Wiring:** 6x B22 (BC), 60 watt maximum globe holder(s).

**Width:** 1150mm **Depth:** 1150mm

**Height:** 575mm + **Suspension:** 12.7mm x 750mm

Also available as a Brooklyn six light, (**P-BROOKLYN-6L**).



### P6R3-4L

Murray four long arm pendant shown in antique nickel with 4x **S152-BL** black linen shades. Hand finished in either polished brass (-PB), old brass (-OB), black bronze (-BB), antique bronze (-AB), antique nickel (-AN), bright chrome (-BC), or powder coated (-PC).

**Wiring:** 4x B22 (BC), 60 watt maximum globe holder(s).

**Weight:** 3.1Kg  
**Width:** 520mm  
**Depth:** 520mm  
**Suspension:** 12.700mm x 750mm

Also available as a three arm pendant (P6R3-3L), and as a five arm pendant (P6R3-5L).



### P-BROOKLYN-4

Brooklyn four light pendant shown in powder coated matt black with 4x **VIN-T9-60-B22** globes. Hand finished in either polished brass (-PB), old brass (-OB), black bronze (-BB), antique bronze (-AB), antique nickel (-AN), bright chrome (-BC) or powder coated (-PC).

**Wiring:** 4x B22 (BC), 60 watt maximum globe holder(s).

**Width:** 1150mm **Depth:** 1150mm  
**Height:** 575mm + **Suspension:** 12.7mm x 750mm

Also available as a Staten four light, with integrated G3DS galleries (**P-STATEN-4**).



### P-STATEN-3

Staten three light pendant with 3x integrated **G3DS** galleries shown in powder coated matt black with 3x **SPH150-OG** glass shades. Hand finished in either polished brass (-PB), old brass (-OB), black bronze (-BB), antique bronze (-AB), antique nickel (-AN), bright chrome (-BC) or powder coated (-PC).

**Wiring:** 6x B22 (BC), 60 watt maximum globe holder(s).

**Width:** 1150mm  
**Depth:** 1150mm  
**Height:** 575mm + **Suspension:** 12.7mm x 750mm

Also available as a Brooklyn three light, (**P-BROOKLYN-3**).

### P-BROOKLYN-2

Brooklyn two light pendant shown in antique bronze with 2x **VIN-LED-ST64-B22** globes. Hand finished in either polished brass (-PB), old brass (-OB), black bronze (-BB), antique bronze (-AB), antique nickel (-AN), bright chrome (-BC) or powder coated (-PC).

**Wiring:** 2x B22 (BC), 60 watt maximum globe holder(s).

**Width:** 1150mm **Depth:** 1150mm  
**Height:** 575mm + **Suspension:** 12.7mm x 750mm

Also available as a Staten two light, with integrated G3DS galleries, (**P-STATEN-2**).



### P-VER4

Four light Verandah cross pendant shown in antique nickel with four **S152-WL** linen shades. Hand finished in either antique bronze (-AB) or antique nickel (-AN).

**Wiring:** 4x B22 (BC), 60 watt maximum globe holder(s).

**Width:** 1060mm **Depth:** 1060mm  
**Height:** 820mm + **Suspension:** 12.7mm x 500mm

(In NSW, this product is available exclusively from Magins Classical Lighting).



### P-VER5

Five light Verandah straight pendant shown in antique bronze with four **S152-WL** linen shades. Hand finished in either antique bronze (-AB) or antique nickel (-AN).

**Wiring:** 5x B22 (BC), 60 watt maximum globe holder(s).

**Width:** 1570mm **Depth:** 515mm  
**Height:** 860mm + **Suspension:** 12.7mm x 500mm

(In NSW, this product is available exclusively from Magins Classical Lighting).



### P-VER6

Six light Verandah round pendant shown in antique bronze with four **S152-WL** linen shades. Hand finished in either antique bronze (-AB) or antique nickel (-AN).

**Wiring:** 6x B22 (BC), 60 watt maximum globe holder(s).

**Width:** 800mm **Depth:** 800mm  
**Height:** 820mm + **Suspension:** 12.7mm x 500mm

Also available as an eight light pendant, hand finished in antique nickel (**P-VER8-AN**).

**Wiring:** 8x B22 (BC), 60 watt maximum globe holder(s).

**Suspension:** 12.7mm x 500mm

(In NSW, this product is available exclusively from Magins Classical Lighting).



### P-TWICK3R-3SPY-AB

Three light Twickenham round pendant with 3x integrated 3 way spiders, shown with three **S6752T** glass shades. Hand finished in antique bronze (-AB).

**Wiring:** 3x B22 (BC), 60 watt maximum globe holder(s).

**Width:** 515mm **Depth:** 515mm

**Height:** 820mm + **Suspension:** 12.7mm x 500mm



### P-TWICK8-G2GS

Eight light Twickenham round pendant with 8x integrated **G2GS** galleries, shown in antique nickel with eight **S1801C** glass shades. Hand finished in either antique bronze (-AB) or antique nickel (-AN).

**Wiring:** 8x B22 (BC), 60 watt maximum globe holder(s).

**Width:** 1150mm **Depth:** 1150mm

**Height:** 820mm + **Suspension:** 12.7mm x 500mm



### P-TWICK6-G2GS

Six light Twickenham round pendant with 6x integrated **G2GS** galleries shown in antique bronze with six **S1017C** glass shades. Hand finished in either antique bronze (-AB) or antique nickel (-AN).

**Wiring:** 6x B22 (BC), 60 watt maximum globe holder(s).

**Width:** 800mm **Depth:** 800mm

**Height:** 820mm + **Suspension:** 12.7mm x 500mm



### P-TWICK3S-G2GS

Three light Twickenham straight pendant with 2x integrated **G2GS** galleries shown in antique nickel with three **S1017C** glass shades and finished in either antique bronze (-AB) or antique nickel (-AN).

**Wiring:** 3x B22 (BC), 60 watt maximum globe holder(s).

**Width:** 800mm **Depth:** 800mm

**Height:** 100mm + **Suspension:** 2x 12.7mm x 750mm



### P-TWICK2-G2GS

Two light Twickenham straight pendant with 2x integrated **G2GS** galleries, shown in antique bronze with two **S1017C** glass shades. Hand finished in either antique bronze (-AB) or antique nickel (-AN).

**Wiring:** 2x B22 (BC), 60 watt maximum globe holder(s).

**Width:** 800mm **Depth:** 800mm

**Height:** 100mm + **Suspension:** 12.7mm x 750mm



### P-GLO-3G4DS

Gloucester three light pendant with 3x integrated **G4DS** galleries shown in antique nickel with 3x **S1550** ribbed glass shades. Hand finished in either polished brass (-PB), old brass (-OB), black bronze (-BB), antique bronze (-AB), antique nickel (-AN), bright chrome (-BC), or powder coated (-PC).

**Wiring:** 3x B22 (BC), 60 watt maximum globe holder(s).

**Width:** 1200mm **Depth:** 100mm

**Height:** 145mm + **Suspension:** 2x 19.050mm x 750mm (spaced 500mm apart)



### P-GLO-3

Gloucester three light pendant shown in old brass with 3x **SML10** old brass shades. Hand finished in either old brass (-OB), antique bronze (-AB), satin nickel (-SN), or powder coated (-PC).

**Wiring:** 3x B22 (BC), 60 watt maximum globe holder(s).

**Width:** 1200mm **Depth:** 100mm

**Height:** 85mm + **Suspension:** 2x 19.050mm x 750mm (spaced 500mm apart).



### P-BRO-3G4DS

Brockworth three light pendant with 3x integrated **G4DS** galleries shown in antique nickel with 3x **S1550** glass shades. Hand finished in either polished brass (-PB), old brass (-OB), black bronze (-BB), antique bronze (-AB), antique nickel (-AN), bright chrome (-BC), or powder coated (-PC).

**Wiring:** 2x B22 (BC), 60 watt maximum globe holder(s).

**Suspension:** 15.875mm x 750mm



### P35-3

Magill three light pendant shown in old brass with 3x **SML14** old brass shades. Hand finished in either old brass (-OB), antique bronze (-AB), satin nickel (-SN), or powder coated (-PC).

**Wiring:** 3x B22 (BC), 60 watt maximum globe holder(s).

**Width:** 1380mm **Depth:** 50mm

**Height:** 225mm + **Suspension:** 15.875mm x 750mm



### P35H44-3

Highgate three light pendant shown in satin nickel with 3x **SML14-SN** shades. Hand finished in either old brass (-OB), antique bronze (-AB), satin nickel (-SN) or powder coated (-PC).

**Wiring:** 2x B22 (BC), 60 watt maximum globe holder(s).

**Suspension:** 15.875mm x 750mm

Available as a two arm pendant (P35H44-2).



### P35-2

Magill two light pendant shown in antique bronze with 2x **SML10** antique bronze shades. Hand finished in either old brass (-OB), antique bronze (-AB), satin nickel (-SN), or powder coated (-PC).

**Wiring:** 2x B22 (BC), 60 watt maximum globe holder(s).

**Width:** 900mm **Depth:** 50mm

**Height:** 225mm + **Suspension:** 15.875mm x 750mm



### P10T5T-3G2DS

Albert three light pendant with 3x integrated **G2DS** galleries shown in polished brass with 3x **SGC12-OG** glass shades. Hand finished in either polished brass (-PB) old brass (-OB), black bronze (-BB), antique bronze (-AB), antique nickel (-AN), bright chrome (-BC), or powder coated (-PC).

**Wiring:** 3x B22 (BC), 60 watt maximum globe holder(s).

**Width:** 1220mm **Depth:** 100mm

**Height:** 550mm + **Suspension:** 19.050mm x 500mm

Also available as a two light pendant, (P10T3T-2G2DS).



### P12T3-2G2DS

Hyde two light pendant with 2x integrated **G2DS** galleries, shown in polished brass with 2x **SGC12-C** glass shades. Hand finished in either polished brass (-PB) old brass (-OB), black bronze (-BB), antique bronze (-AB), antique nickel (-AN), bright chrome (-BC), or powder coated (-PC).

**Wiring:** 2x B22 (BC), 60 watt maximum globe holder(s).

**Width:** 835mm **Depth:** 120mm

**Height:** 620mm + **Suspension:** 19.050mm x 500mm



### P7T3-2G2DS

Whitmore two light pendant with 2x integrated **G2DS** galleries shown in polished brass with 2x **SGC12-G** glass shades. Hand finished in either polished brass (-PB) old brass (-OB), black bronze (-BB), antique bronze (-AB), antique nickel (-AN), bright chrome (-BC) or powder coated (-PC).

**Wiring:** 2x B22 (BC), 60 watt maximum globe holder(s).

**Width:** 760mm **Depth:** 70mm

**Height:** 445mm +

**Suspension:** 12.700mm x 500mm

Also available as a three light pendant (P7T5-3G2DS)

**Width:** 1200mm



### P1200-3G2DS

Belair three light satin nickel pendant shown with 3x **SMC12-PC** gloss black shades.

**Wiring:** 3x B22 (BC), 60 watt maximum globe holder(s).

**Width:** 1200mm **Depth:** 100mm

**Height:** 70mm + **Suspension:** 2x SS wires x 1000mm + clear cable



### P7T3D-2G2DS

Stirling two light pendant with 2x integrated **G2DS** galleries shown in antique bronze with 2x **SGC12-OG** glass shades. Hand finished in either polished brass (-PB) old brass (-OB), black bronze (-BB), antique bronze (-AB), antique nickel (-AN), bright chrome (-BC) or powder coated (-PC).

**Wiring:** 2x B22 (BC), 60 watt maximum globe holder(s).

**Width:** 750mm **Depth:** 70mm  
**Height:** 370mm + **Suspension:** 15.875mm x 500mm



### P7T5D-3G2DS

Stirling three light pendant with 3x integrated **G2DS** galleries shown in antique bronze with 3x **SGC12-OG** glass shades. Hand finished in either polished brass (-PB) old brass (-OB), black bronze (-BB), antique bronze (-AB), antique nickel (-AN), bright chrome (-BC), or powder coated (-PC).

**Wiring:** 3x B22 (BC), 60 watt maximum globe holder(s).

**Width:** 1200mm **Depth:** 70mm  
**Height:** 370mm + **Suspension:** 15.875mm x 500mm



### P5R73-3

Fulham three arm pendant shown in satin nickel with 3x **S310** glass shades. Hand finished in either polished brass (-PB), old brass (-OB), black bronze (-BB), antique bronze (-AB), antique nickel (-AN), satin nickel (-SN), or bright chrome (-BC).

**Wiring:** 3x B22 (BC), 60 watt maximum globe holder(s).

**Width:** 500mm **Depth:** 500mm  
**Height:** 120mm + **Suspension:** 12.700mm x 500mm



### P8SN-3

McLaren three arm pendant shown in antique bronze with 3x **S310** glass shades. Hand finished in either polished brass (-PB), old brass (-OB), black bronze (-BB), antique bronze (-AB), antique nickel (-AN), satin nickel (-SN), or bright chrome (-BC).

**Wiring:** 3x B22 (BC), 60 watt maximum globe holder(s).

**Width:** 500mm **Depth:** 500mm  
**Height:** 160mm +  
**Suspension:** 12.700mm x 500mm



### P8SN-5

McLaren five arm pendant shown in black bronze with 5x **G2** black bronze galleries and 5x **S2170** glass shades. Hand finished in either polished brass (-PB), old brass (-OB), black bronze (-BB), antique bronze (-AB), antique nickel (-AN), satin nickel (-SN), or bright chrome (-BC).

**Wiring:** 5x B22 (BC), 60 watt maximum globe holder(s).

**Width:** 500mm **Depth:** 500mm  
**Height:** 160mm +  
**Suspension:** 12.700mm x 500mm



### P8F2-2G2GS

Lindfield two arm pendant with 2x integrated **G2GS** galleries, shown in antique nickel with 2x **S8044-9** ribbed glass shades. Hand finished in either polished brass (-PB), old brass (-OB), black bronze (-BB), antique bronze (-AB), antique nickel (-AN), bright chrome (-BC), or powder coated (-PC).

**Wiring:** 2x B22 (BC), 60 watt maximum globe holder(s).

**Width:** 510mm **Depth:** 80mm

**Height:** 150mm + **Suspension:** 19.050mm x 750mm (fluted).

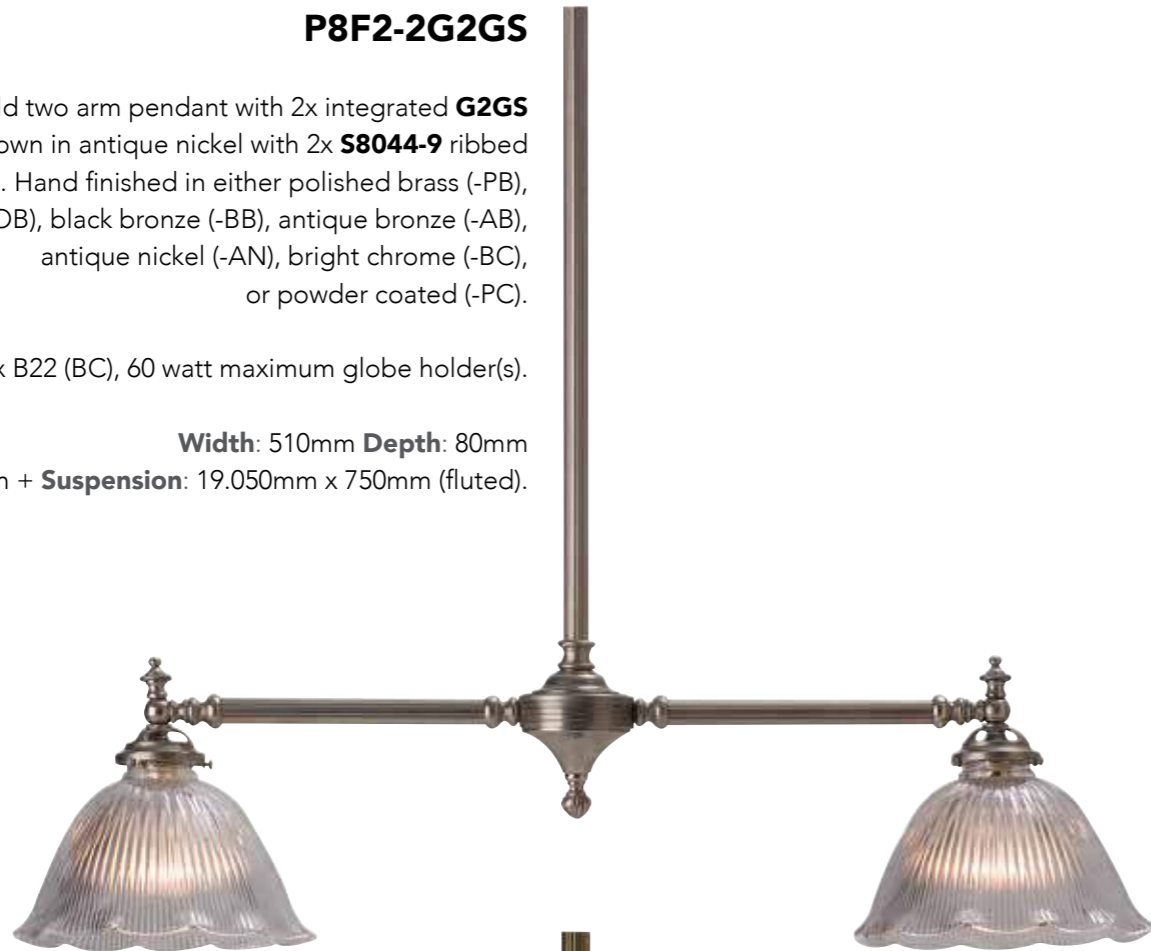

### P8F2-3G2GS

Lindfield three arm pendant with 3x integrated **G2GS** galleries, shown in old brass with 3x **S8044-6** ribbed glass shades. Hand finished in either polished brass (-PB), old brass (-OB), black bronze (-BB), antique bronze (-AB), antique nickel (-AN), bright chrome (-BC), or powder coated (-PC).

**Wiring:** 3x B22 (BC), 60 watt maximum globe holder(s).

**Width:** 510mm **Depth:** 510mm

**Height:** 150mm + **Suspension:** 19.050mm x 750mm (fluted).



### P8P2-4G2GS

Killara four arm pendant with 4x integrated **G2GS** galleries, shown in old brass with 4x **S8044-6** ribbed glass shades. Hand finished in either polished brass (-PB), old brass (-OB), black bronze (-BB), antique bronze (-AB), antique nickel (-AN), bright chrome (-BC), or powder coated (-PC).

**Wiring:** 4x B22 (BC), 60 watt maximum globe holder(s).

**Width:** 510mm **Depth:** 510mm

**Height:** 150mm + **Suspension:** 19.050mm x 750mm (patterned).



### P8H2-3

Paddington three arm pendant shown in antique bronze with 3x **G2** antique bronze galleries and 3x **S2515** ribbed glass shades. Hand finished in either polished brass (-PB), old brass (-OB), black bronze (-BB), antique bronze (-AB), antique nickel (-AN), bright chrome (-BC), or powder coated (-PC).

**Wiring:** 3x B22 (BC), 60 watt maximum globe holder(s).

**Width:** 465mm **Depth:** 465mm

**Height:** 150mm + **Suspension:** 19.050mm x 750mm





### P7S-3D

Gilles three arm pendant shown in polished brass with 3x **S1702** glass shades. Hand finished in either polished brass (-PB), old brass (-OB), black bronze (-BB), antique bronze (-AB), antique nickel (-AN), bright chrome (-BC) or powder coated (-PC).

**Wiring:** 3x B22 (BC), 60 watt maximum globe holder(s).

**Width:** 560mm **Depth:** 560mm

**Height:** 170mm + **Suspension:** 12.700mm x 750mm

Also available as a two arm (P7S-2D) and as a five arm (P7S-5D).



### P10H377-3

Leabrook three arm pendant shown in polished brass with 3x **G2F** polished brass galleries and 3x **S93254** glass shades. Hand finished in either polished brass (-PB), old brass (-OB), black bronze (-BB), antique bronze (-AB), antique nickel (-AN), bright chrome (-BC), or powder coated (-PC).

**Wiring:** 3x B22 (BC), 60 watt maximum globe holder(s).

**Width:** 560mm **Depth:** 560mm

**Height:** 230mm +

**Suspension:** 12.700mm x 750mm

Also available as a five arm (P10H337-5).



### P7S-3

Gilbert three arm pendant shown in polished brass with 3x **S1700** glass shades. Hand finished in either polished brass (-PB), old brass (-OB), black bronze (-BB), antique bronze (-AB), antique nickel (-AN), bright chrome (-BC), or powder coated (-PC).

**Wiring:** 3x B22 (BC), 60 watt maximum globe holder(s).

**Width:** 560mm **Depth:** 560mm

**Height:** 170mm + **Suspension:** 12.700mm x 750mm Also available as a two arm (P7S-2) and as a five arm (P7S-5).



### P7F-3

Fisher three arm pendant shown in polished brass with 3x **S92137** glass shades. Hand finished in either polished brass (-PB), old brass (-OB), black bronze (-BB), antique bronze (-AB), antique nickel (-AN), bright chrome (-BC) or powder coated (-PC).

**Wiring:** 2x B22 (BC), 60 watt maximum globe holder(s).

**Width:** 400mm **Depth:** 400mm

**Height:** 130mm + **Suspension:**

12.700mm x 750mm

Also available as a two arm (P7F-2) and as a five arm (P7F-5).



### P8MD-5

Grange five arm pendant shown in polished brass with 5x **S92720** glass shades. Hand finished in either polished brass (-PB), old brass (-OB), black bronze (-BB), antique bronze (-AB), antique nickel (-AN), bright chrome (-BC) or powder coated (-PC).

**Wiring:** 5x B22 (BC), 60 watt maximum globe holder(s).

**Width:** 590mm **Depth:** 590mm

**Height:** 240mm + **Suspension:** 12.700mm x 750mm,

Also available as a three arm (P8MD-3) and as a two arm (P8MD-2).

### P5D67-2

Liverpool two arm pendant shown in polished brass with 2x **G2F** polished brass galleries and 2x **S2758** glass shades. Hand finished in either polished brass (-PB), old brass (-OB), black bronze (-BB), antique bronze (-AB), antique nickel (-AN), or bright chrome (-BC).

**Wiring:** 2x B22 (BC), 60 watt maximum globe holder(s).

**Width:** 500mm **Depth:** 500mm

**Height:** 280mm + **Suspension:** 12.700mm x 750mm,

Available as a three arm (P5D67-3) and as a five arm (P5D67-5).



### P8UGS-5

Frome five arm pendant shown in polished brass with 5x **G2F** polished brass galleries and 5x **S2758** glass shades. Hand finished in either polished brass (-PB), old brass (-OB), black bronze (-BB), antique bronze (-AB), antique nickel (-AN), or bright chrome (-BC).

**Wiring:** 5x B22 (BC), 60 watt maximum globe holder(s).

**Width:** 640mm **Depth:** 640mm

**Height:** 175mm + **Suspension:** 12.700mm x 750mm,  
Also available as a three arm (P8UGS-3).



### P7G-3D

Currie three arm pendant shown in polished brass with 3x **S1701** glass shades. Hand finished in either polished brass (-PB), old brass (-OB), black bronze (-BB), antique bronze (-AB), antique nickel (-AN), bright chrome (-BC).

**Wiring:** 3x B22 (BC), 60 watt maximum globe holder(s).

**Width:** 435mm **Depth:** 435mm

**Height:** 290mm +  
**Suspension:** 12.700mm x 750mm,

Also available as a two arm (P7G-2D)  
and as a five arm (P7G-5D).



### P7G-3DS

Hindley three arm pendant shown in polished brass with 3x **G2** polished brass galleries and 3x **S93039** glass shades. Hand finished in either polished brass (-PB), old brass (-OB), black bronze (-BB), antique bronze (-AB), antique nickel (-AN), bright chrome (-BC).

**Wiring:** 3x B22 (BC), 60 watt maximum globe holder(s).

**Width:** 435mm **Depth:** 435mm

**Height:** 290mm + **Suspension:** 12.700mm x 750mm

Also available as a two arm (P7G-2DS) and as a five arm (P7G-5DS).



### P7G-3DST

Kingston three arm pendant shown in polished brass with 3x **G2F** polished brass galleries and 3x **S2740** glass shades. Hand finished in either polished brass (-PB), old brass (-OB), black bronze (-BB), antique bronze (-AB), antique nickel (-AN), bright chrome (-BC), or powder coated (-PC).

**Wiring:** 3x B22 (BC), 60 watt maximum globe holder(s).

**Width:** 435mm **Depth:** 435mm

**Height:** 290mm + **Suspension:** 12.700mm x 750mm

Also available as a two arm (P7G-2DST) and as a five arm (P7G-5DST).



### P7G-3

Waymouth three arm pendant shown in polished brass with 3x **G2F** polished brass galleries and 3x **S7598** glass shades. Hand finished in either polished brass (-PB), old brass (-OB), black bronze (-BB), antique bronze (-AB), antique nickel (-AN), bright chrome (-BC), or powder coated (-PC).

**Wiring:** 3x B22 (BC), 60 watt maximum globe holder(s).

**Width:** 435mm **Depth:** 435mm

**Height:** 290mm + **Suspension:** 12.700mm x 750mm,

Also available as a two arm (P7G-2)  
and as a five arm (P7G-5).





### P12U12-9

Angas nine arm pendant shown in polished brass with 9x **G4** polished brass galleries and 9x **SPH250-AE** glass shades. Hand finished in either polished brass (-PB), old brass (-OB), black bronze (-BB), antique bronze (-AB), antique nickel (-AN), bright chrome (-BC), or powder coated (-PC).

**Wiring:** 9x B22 (BC), 60 watt maximum globe holder(s).

**Width:** 760mm **Depth:** 760mm

**Height:** 540mm + **Suspension:** 19.050mm x 1000mm

Also available as a one tier pendant with 3, 5 or 7 arms, (see page 282).



### P12U34-7

Grenfell seven arm pendant shown in polished brass with 7x **G4** polished brass galleries and 7x **SPH250-AE** glass shades. Hand finished in either polished brass (-PB), old brass (-OB), black bronze (-BB), antique bronze (-AB), antique nickel (-AN), bright chrome (-BC), or powder coated (-PC).

**Wiring:** 7x B22 (BC), 60 watt maximum globe holder(s).

**Width:** 760mm **Depth:** 760mm

**Height:** 325mm +

**Suspension:** 19.050mm x 1000mm

Also available with 3 arms or 5 arms or as a two tier 9 arm, P12U34-3, P12U34-5 and P12U34-9 respectively.

### P12U34-5DG4GS

Keswick five arm pendant with 5x integrated **G4GS** galleries shown in polished brass with 5x **SPH250-AE** glass shades. Hand finished in either polished brass (-PB), old brass (-OB), black bronze (-BB), antique bronze (-AB), antique nickel (-AN), or bright chrome (-BC).

**Wiring:** 5x B22 (BC), 60 watt maximum globe holder(s).

**Width:** 760mm **Depth:** 760mm

**Height:** 630mm + **Suspension:** 19.050mm x 750mm.





**P10U8-3**

Wakefield three arm pendant shown in polished brass with 3x **G4** polished brass galleries and 3x **SPH200-OG** glass shades. Hand finished in either polished brass (-PB), old brass (-OB), black bronze (-BB), antique bronze (-AB), antique nickel (-AN), bright chrome (-BC), or powder coated (-PC).

**Wiring:** 3x B22 (BC), 60 watt maximum globe holder(s).

**Width:** 560mm **Depth:** 560mm  
**Height:** 275mm +  
**Suspension:** 19.050mm x 1000mm,  
Available as a 2 arm (P10U8-2)  
or as a 5 arm (P10U8-5).



**P8U8-3D**

Flinders three arm pendant shown in polished brass with 3x **G4** polished brass galleries and 3x **SPH200-AE** glass shades. Hand finished in either polished brass (-PB), old brass (-OB), black bronze (-BB), antique bronze (-AB), antique nickel (-AN), or bright chrome (-BC).

**Wiring:** 3x B22 (BC), 60 watt maximum globe holder(s).

**Width:** 560mm **Depth:** 560mm  
**Height:** 275mm + **Suspension:** 19.050mm x 1000mm,

Also available as a 2 arm (P8U8-2D)  
or as a 5 arm (P8U8-5D).



**P10U8S-3**

Devonshire three arm pendant shown in polished brass with 3x **S4745** glass shades. Hand finished in either polished brass (-PB), old brass (-OB), black bronze (-BB), antique bronze (-AB), antique nickel (-AN), or bright chrome (-BC).

**Wiring:** 3x B22 (BC), 60 watt maximum globe holder(s).

**Width:** 560mm **Depth:** 560mm  
**Height:** 275mm +  
**Suspension:** 19.050mm x 1000mm  
Also available as a 2 arm (P10U8S-2)  
or as a 5 arm (P10U8S-5).



**P7U6-3D**

Halifax three arm pendant shown in polished brass with 3x **G3** polished brass galleries and 3x **SPH150-AE** glass shades. Hand finished in either polished brass (-PB), old brass (-OB), black bronze (-BB), antique bronze (-AB), antique nickel (-AN), or bright chrome (-BC).

**Wiring:** 3x B22 (BC), 60 watt maximum globe holder(s).

**Width:** 425mm **Depth:** 425mm  
**Height:** 185mm + **Suspension:** 12.700mm x 750mm,

Available as a 2 arm (P7U6-2D)  
or as a 5 arm (P7U6-5D).

**P7U4-3**

Morphett three arm pendant shown in polished brass with 3x **G2** polished brass galleries and 3x **S3004** glass shades. Hand finished in either polished brass (-PB), old brass (-OB), black bronze (-BB), antique bronze (-AB), antique nickel (-AN), bright chrome (-BC), or powder coated (-PC).

**Wiring:** 3x B22 (BC), 60 watt maximum globe holder(s).

**Width:** 370mm  
**Depth:** 370mm  
**Height:** 170mm +  
**Suspension:** 12.700mm x 750mm,  
Also available as a 5 arm (P7U4-5).



**P8U384-3**

Leigh three arm pendant shown in polished brass with 3x **S92426** glass shades. Hand finished in either polished brass (-PB), old brass (-OB), black bronze (-BB), antique bronze (-AB), antique nickel (-AN), bright chrome (-BC), or powder coated (-PC).

**Wiring:** 3x B22 (BC), 60 watt maximum globe holder(s).

**Width:** 370mm **Depth:** 370mm  
**Height:** 170mm + **Suspension:** 12.700mm x 750mm.

**P7U6-3**

Carrington three arm pendant shown in polished brass with 3x **G3** polished brass galleries and 3x **SPH150-OG** shades. Hand finished in either polished brass (-PB), old brass (-OB), black bronze (-BB), antique bronze (-AB), antique nickel (-AN), bright chrome (-BC), or powder coated (-PC).

**Wiring:** 3x B22 (BC), 60 watt maximum globe holder(s).

**Width:** 425mm **Depth:** 425mm  
**Height:** 185mm + **Suspension:** 12.700mm x 750mm.



### P12U12-5

Angas five arm pendant shown in polished brass with 5x **G4** polished brass galleries and 5x **SPH250-OG** glass shades. Hand finished in either polished brass (-PB), old brass (-OB), black bronze (-BB), antique bronze (-AB), antique nickel (-AN), bright chrome (-BC), or powder coated (-PC).

**Wiring:** 5x B22 (BC), 60 watt maximum globe holder(s).

**Width:** 760mm  
**Depth:** 760mm  
**Height:** 320mm +  
**Suspension:** 19.050mm x 1000mm,  
Also available as a 3 arm (P12U12-3)  
or as a 7 arm (P12U12-7) and as a nine arm  
two tier pendant (P12U12-9, see page 278).



### P12U348-5

Chesser five arm pendant shown in polished brass with 5x **G4** polished brass galleries and 5x **SPH200-OG** glass shades. Hand finished in either polished brass (-PB), old brass (-OB), black bronze (-BB), antique bronze (-AB), antique nickel (-AN), bright chrome (-BC), or powder coated (-PC).

**Wiring:** 5x B22 (BC), 60 watt maximum globe holder(s).

**Width:** 620mm  
**Depth:** 620mm  
**Height:** 300mm +  
**Suspension:** 19.050mm x 750mm,  
Also available as a 3 arm (P12U348-3)  
or as a 7 arm (P12U348-7).

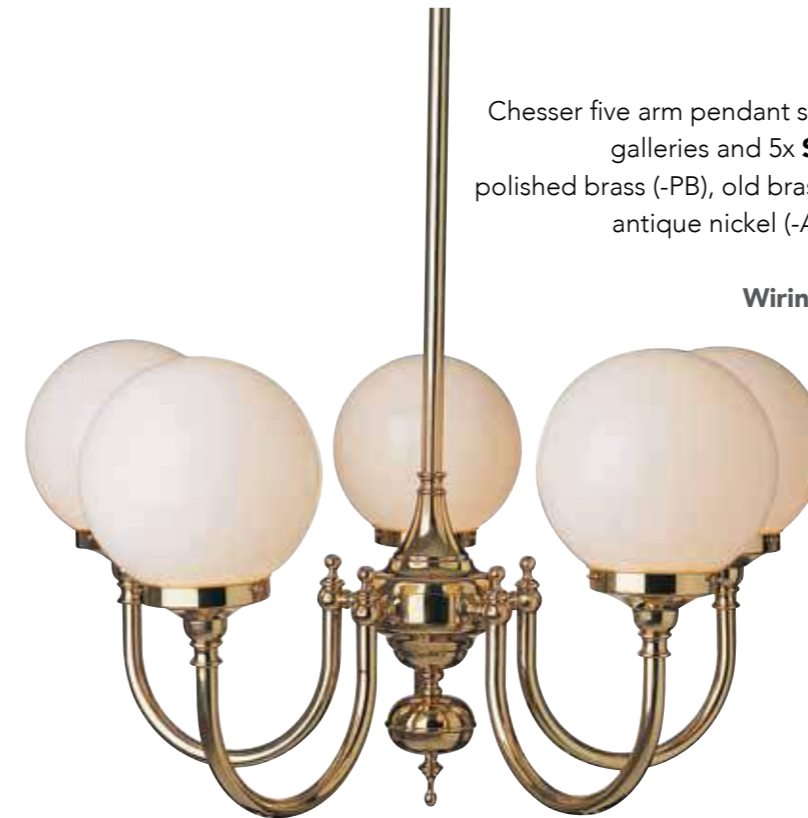

### P14U16-5G4GS

Richmond five arm pendant with 5x integrated **G4GS** galleries shown in polished brass with 5x **SPH250-AE** glass shades. Hand finished in either polished brass (-PB), old brass (-OB), black bronze (-BB), antique bronze (-AB), antique nickel (-AN), or bright chrome (-BC).

**Wiring:** 5x B22 (BC), 60 watt maximum globe holder(s).

**Width:** 940mm **Depth:** 940mm  
**Height:** 320mm +  
**Suspension:** 19.050mm x 1000mm.

Also available as a 3 arm (P14U14-3) or as a 7 arm (P14U14-7) and available as a nine arm two tier pendant (P14U14-9) and a twelve arm two tier pendant (P14U14-12).



### P10U8-5DSC

Nelson five arm pendant shown in polished brass with 5x **G4** polished brass galleries and 5x **SPH200-AE** glass shades. Hand finished in either polished brass (-PB), old brass (-OB), black bronze (-BB), antique bronze (-AB), antique nickel (-AN), or bright chrome (-BC).

**Wiring:** 5x B22 (BC), 60 watt maximum globe holder(s).

**Width:** 600mm  
**Depth:** 600mm  
**Height:** 265mm +  
**Suspension:** 19.050mm x 1000mm

Also available as a 3 arm (P10U8-3).



### P8A52-3G2GS

Cleveland three arm pendant with 3x integrated **G2GS** galleries shown in polished brass with 3x **S2170** glass shades. Hand finished in either polished brass (-PB), old brass (-OB), black bronze (-BB), antique bronze (-AB), antique nickel (-AN), or bright chrome (-BC).

**Wiring:** 3x B22 (BC), 60 watt maximum globe holder(s).

**Width:** 710mm **Depth:** 710mm  
**Height:** 330mm + **Suspension:** 12.700mm x 750mm,  
Also available as a two arm (P8A52-2), a four arm (P8A52-4) and as a five arm (P8A52-5).



### P10CW-3G4GS

Clifton three arm pendant with 3x integrated **G4GS** galleries, shown in polished brass with 3x **S605** glass shades. Hand finished in either polished brass (-PB), old brass (-OB), black bronze (-BB), antique bronze (-AB), antique nickel (-AN), or bright chrome (-BC).

**Wiring:** 3x B22 (BC), 60 watt maximum globe holder(s).

**Weight:** 4.XKg **Width:** 680mm **Depth:** 680mm  
**Height:** 470mm + **Suspension:** 12.700mm x 300mm,  
Also available as a two arm (P10CW-2) and as a four arm (P10CW-4).



### P12H351-5G4GS

Tusmore five arm pendant with 5x integrated **G4GS** galleries shown in polished brass with 5x **SPH200-AE** glass shades. Hand finished in either polished brass (-PB), old brass (-OB), black bronze (-BB), antique bronze (-AB), antique nickel (-AN), or bright chrome (-BC).

**Wiring:** 5x B22 (BC), 60 watt maximum globe holder(s),

**Width:** 680mm **Depth:** 680mm  
**Height:** 480mm + **Suspension:** 19.050mm x 750mm,  
Also available as a three arm (P12H351-3).



### P10A51CW-5G2GS

Malvern five arm pendant with 5x integrated **G2GS** galleries, shown in polished brass with 5x **S3133** glass shades. Hand finished in either polished brass (-PB), old brass (-OB), black bronze (-BB), antique bronze (-AB), antique nickel (-AN), or bright chrome (-BC).

**Wiring:** 5x B22 (BC), 60 watt maximum globe holder(s).

**Weight:** 6.5Kg **Width:** 700mm **Depth:** 700mm  
**Height:** 680mm + **Suspension:** 12.700mm x 300mm,  
Also available as a two arm (P10A51CW-2) and as a three arm (P10A51CW-3).



### P12H246-5

Hayborough five arm pendant shown in old brass with 5x **G4G** old brass galleries and 5x **S604** glass shades. Hand finished in either polished brass (-PB), old brass (-OB), black bronze (-BB), antique bronze (-AB), antique nickel (-AN), or bright chrome (-BC).

**Wiring:** 5x B22 (BC), 60 watt maximum globe holder(s).

**Weight:** 9.0Kg **Width:** 760mm **Depth:** 760mm  
**Height:** 350mm + **Suspension:** 19.050mm x 750mm,  
Also available as a three arm (P12H246-3).



### P10H221-5

Kensington five arm pendant shown in polished brass with 5x **G4G** polished brass galleries and 5x **S603** glass shades. Hand finished in either polished brass (-PB), old brass (-OB), black bronze (-BB), antique bronze (-AB), antique nickel (-AN), or bright chrome (-BC).

**Wiring:** 5x B22 (BC), 60 watt maximum globe holder(s).

**Weight:** 8.5Kg **Width:** 640mm **Depth:** 640mm  
**Height:** 380mm + **Suspension:** 19.050mm x 750mm,  
Also available as a three arm (P10H221-3).



### P14H245-5G4GS

Trinity five arm pendant with 5x integrated **G4GS** galleries, shown in old brass with 5x **S602** glass shades. Hand finished in either polished brass (-PB), old brass (-OB), black bronze (-BB), antique bronze (-AB), antique nickel (-AN), or bright chrome (-BC).

**Wiring:** 5x B22 (BC), 60 watt maximum globe holder(s).

**Weight:** 11.5Kg **Width:** 630mm **Depth:** 630mm  
**Height:** 400mm + **Suspension:** 19.050mm x 750mm,  
Also available as a three arm (P14H245-3).

### P10FH190-3

Burnside three arm pendant shown in polished brass with 3x **G2F** polished brass galleries and 3x **S96930** glass shades. Hand finished in either polished brass (-PB), old brass (-OB), black bronze (-BB), antique bronze (-AB), antique nickel (-AN), or bright chrome (-BC).

**Wiring:** 3x B22 (BC), 60 watt maximum globe holder(s).

**Weight:** 4.0Kg **Width:** 470mm **Depth:** 470mm  
**Height:** 400mm + **Suspension:** 12.700mm x 750mm,  
Also available as a five arm (P10FH190-5).



### P8FH191-3

Norwood three arm pendant shown in polished brass with 3x **S163** glass shades. Hand finished in either polished brass (-PB), old brass (-OB), black bronze (-BB), antique bronze (-AB), antique nickel (-AN), or bright chrome (-BC).

**Wiring:** 3x B22 (BC), 60 watt maximum globe holder(s).

**Weight:** 3.5Kg **Width:** 470mm **Depth:** 470mm  
**Height:** 370mm +  
**Suspension:** 12.700mm x 750mm,  
Also available as a five arm (P8FH191-5).



### P35A50-2G2FS

Hawthorn two arm pendant with 2x integrated **G2FS** galleries, shown in polished brass with 2x **S930** glass shades. Hand finished in either polished brass (-PB), old brass (-OB), black bronze (-BB), antique bronze (-AB), antique nickel (-AN), or bright chrome (-BC).

**Wiring:** 2x B22 (BC), 60 watt maximum globe holder(s).

**Weight:** 2.5Kg **Width:** 640mm **Depth:** 65mm  
**Height:** 190mm + **Suspension:** 12.700mm x 750mm,  
Also available as a three, four or five arm pendant. (P35A50-3 P35A50-4, P35A50-5 respectively).



### P35A53-3G4GS

Aldgate three arm pendant with 3x integrated **G4GS** galleries, shown in polished brass with 3x **S601** glass shades. Hand finished in either polished brass (-PB), old brass (-OB), black bronze (-BB), antique bronze (-AB), antique nickel (-AN), or bright chrome (-BC).

**Wiring:** 3x B22 (BC), 60 watt maximum globe holder(s).

**Weight:** 3.0Kg **Width:** 500mm **Depth:** 500mm  
**Height:** 380mm +  
**Suspension:** 12.700mm x 750mm,  
Also available as a two, four or five arm pendant (P35A53-2, P35A53-4, P35A53-5 respectively).



### P35A49-3G2FS

Conway three arm pendant with 3x integrated **G2FS** galleries, shown in polished brass with 3x **S93036** glass shades. Hand finished in either polished brass (-PB), old brass (-OB), black bronze (-BB), antique bronze (-AB), antique nickel (-AN), or bright chrome (-BC).

**Wiring:** 3x B22 (BC), 60 watt maximum globe holder(s).

**Weight:** 5.5Kg **Width:** 500mm **Depth:** 500mm  
**Height:** 380mm + **Suspension:** 12.700mm x 750mm  
Also available as a two, four or five arm pendant (P35A49-2 P35A49-4, P35A49-5 respectively).





### P10FH288-3

Glenelg three arm pendant shown in polished brass with 3x **G2F** polished brass galleries and 3x **S93039** glass shades. Hand finished in either polished brass (-PB), old brass (-OB), black bronze (-BB), antique bronze (-AB), antique nickel (-AN), or bright chrome (-BC).

**Wiring:** 3x B22 (BC), 60 watt maximum globe holder(s).

**Weight:** 6.0Kg **Width:** 580mm **Depth:** 580mm  
**Height:** 240mm + **Suspension:** 19.050mm x 1000mm  
Also available as a five arm pendant (P10FH288-5).



### P8FH228-3

Brighton three arm pendant shown in polished brass with 3x **S505** glass shades. Hand finished in either polished brass (-PB), old brass (-OB), black bronze (-BB), antique bronze (-AB), antique nickel (-AN), or bright chrome (-BC).

**Wiring:** 3x B22 (BC), 60 watt maximum globe holder(s).

**Weight:** 5.0Kg **Width:** 580mm **Depth:** 580mm  
**Height:** 240mm +  
**Suspension:** 12.700mm x 750mm  
Also available as a five arm pendant (P8FH228-5).



### P10H299-3

Ascot three arm pendant shown in old brass with 3x **G2F** old brass galleries and 3x **S1509** glass shades. Hand finished in either polished brass (-PB), old brass (-OB), black bronze (-BB), antique bronze (-AB), antique nickel (-AN), or bright chrome (-BC).

**Wiring:** 3x B22 (BC), 60 watt maximum globe holder(s).

**Weight:** 4.0Kg **Width:** 520mm **Depth:** 520mm  
**Height:** 250mm + **Suspension:** 19.050mm x 750mm  
Also available as a five arm pendant (P10FH299-5).



### P10H300-5

Flemington five arm pendant shown in antique bronze with 5x **G4G** antique bronze galleries and 5x **S706** glass shades. Hand finished in either polished brass (-PB), old brass (-OB), black bronze (-BB), antique bronze (-AB), antique nickel (-AN), or bright chrome (-BC).

**Wiring:** 5x B22 (BC), 60 watt maximum globe holder(s).

**Weight:** 7.5Kg **Width:** 720mm **Depth:** 720mm  
**Height:** 290mm + **Suspension:** 19.050mm x 750mm



### P35H183-3

Walkerville three arm pendant shown in old brass with 3x **G3** old brass galleries and 3x **S1060** glass shades. Hand finished in either polished brass (-PB), old brass (-OB), black bronze (-BB), antique bronze (-AB), antique nickel (-AN), or bright chrome (-BC).

**Wiring:** 3x B22 (BC), 60 watt maximum globe holder(s).

**Weight:** 4.5Kg **Width:** 295mm **Depth:** 295mm  
**Height:** 110mm + **Suspension:** 12.700mm x 750mm



### P8H551-3G3GS

Veneto three arm Italian die cast pendant with 3x integrated **G3GS** galleries, shown in old brass with 3x **S1060** glass shades. Hand finished in either polished brass (-PB), old brass (-OB), black bronze (-BB), antique bronze (-AB), antique nickel (-AN), or bright chrome (-BC).

**Wiring:** 3x B22 (BC),  
60 watt maximum globe holder(s).

**Weight:** 6.0Kg **Width:** 360mm **Depth:** 360mm  
**Height:** 240mm +  
**Suspension:** 19.050mm x 750mm (patterned),

Available with candle globe holders instead of gas galleries as the Rosaline model, (P8H551-3CB22), suits shade, and as the Juliet model, with E14 globe holders, (P8H551-3CNDL).



### P8H553-5G4GS

Verona five arm Italian die cast pendant with 5x integrated **G4GS** galleries, shown in old brass with 5x **SVL1** glass shades. Hand finished in either polished brass (-PB), old brass (-OB), black bronze (-BB), antique bronze (-AB), antique nickel (-AN), or bright chrome (-BC).

**Wiring:** 5x B22 (BC), 60 watt maximum globe holder(s).

**Weight:** 11.0Kg **Width:** 680mm **Depth:** 680mm  
**Height:** 320mm + **Suspension:** 19.050mm x  
750mm (patterned),

Available with candle globe holders instead of gas galleries as the Mercurio model, (P8H553-5CB22), suits shade and with B15 globe holders as the Romeo model, (P8H553-5CNDL).



### P14H27-3G3GS

Winged Siren three light pendant with 3x integrated **G3GS** galleries, shown in bright nickel with 3x **S1060** glass shades. Hand finished in either polished brass (-PB), or bright nickel (-BN). Other finishes available.

**Wiring:** 3x B22 (BC), 60 watt maximum globe holder(s).

**Weight:** 11.0Kg **Width:** 680mm **Depth:** 680mm

**Height:** 320mm + **Suspension:** 19.050 x 1000mm (patterned).



### P14H463-3G3S

Millswood three light pendant with 3x integrated **G3GS** galleries shown in black bronze with 3x **S94029** glass shades. Hand finished in either polished brass (-PB), old brass (-OB), black bronze (-BB), antique bronze (-AB), antique nickel (-AN), or bright chrome (-BC)

**Wiring:** 3x B22 (BC), 60 watt maximum globe holder(s).

**Weight:** 7.1Kg **Width:** 480mm **Depth:** 480mm  
**Height:** 340mm + **Suspension:** 19.050 x 750mm



### P300H27-6G3GS

Winged Siren six light pendant with 6x integrated **G3GS** galleries, shown in polished brass with 6x **S1060** glass shades. Hand finished in either polished brass (-PB), or bright nickel (-BN). Other finishes available.

**Wiring:** 6x B22 (BC), 60 watt maximum globe holder(s).

**Weight:** 25.0Kg **Width:** 840mm **Depth:** 840mm

**Height:** 1150mm + **Suspension:** 500mm x C5 chain.



# Glossary

## **Back plate**

A metal piece which fixes to a wall or ceiling and is joined to the arm(s) of a wall light or suspension of a ceiling light. Unlike a canopy this piece is not adjustable along a tube, making a rod suspension mounted by a back plate fixed in length.

## **Canopy**

The decorative cover piece which grips to the suspension rod or top stem above chain or cord. The purpose is to hide the terminating wires and suspension hook, at the top of the fitting.

## **Centre**

The round metal piece which is used to terminate the wires and hold the arms of pendant lights. Often this piece is larger for fittings with more or larger arms. The piece often is covered with a decorative cup, a finial below and a column above it.

## **Column**

A metal decorative piece above the centre of a fitting but below the suspension. Can range from tall, elaborate and ornate castings to small pressed pieces, if anything at all, in a pendant fitting.

## **Arm**

The metalware piece of a multiple light pendant where the light sources are projected from a centre. Similarly an arm can be from the back plate of a wall bracket.

## **Gallery**

A round metal piece attached to the arms of the fitting. Either in built before the globe holder or held by the shade ring, the round metal piece comes in various sizes and serves the purpose of holding and displaying with the aid of gallery screws a glass shade.

## **Shade**

An attachment to a fitting covering illuminating sources to reduce, diffuse or reflect light from the source. Shades are made from glass, metal or fabric and come in various shapes and sizes sometimes with ornate patterns or decorations.

## **Shade Ring**

A ring which tightens a gallery down, or a shade in the case of a fitting without a gallery.

## **Suspension**

The top of a pendant fitting which drops the centre and arms to the desired height. Suspensions can be in the form of a rod, chain or simply restrained electrical cable. Suspensions can often be shortened upon installation to allow a fitting to correctly hang at the desired height.

## **Lumen**

A standard unit for measuring the total quantity of visible light emitted by a source. Fittings with higher lumen outputs, are brighter than those with lower lumen outputs.

## **Watt**

A standard unit of power or the rate of energy consumed. Fittings with lower wattages use less power for the same amount of use as a fitting with higher wattages. However watts should not be confused with lumens, watts being only a unit of power.

## **Kelvin**

A standard measure of thermodynamic temperature. Used to measure light sources appearances. Lower temperatures (2000-4000) are warmer and yellower in colour, used mostly for intimate and decorative lighting, whereas higher kelvin temperatures appear whiter or bluer and are used more so in commercial settings for focus and task oriented lighting.

## **Die Cast**

A manufacturing process where molten metal is poured in to a precisely engineered steel mould, resulting in solid and accurate metal pieces which can be extremely detailed and ornate.

## **Sand Cast**

A manufacturing process where molten metal is poured into a mould made of sand. Compared to a die cast this allows for cheaper costs, however pieces can be slightly less precise.

## **Pressed**

A stamping process where sheet metal is put under great force between two moulding pieces. Pressed metal is stronger thinner and lighter, however it may be more prone to denting or bending.

## **Spun**

A cost effective metal forming process which gives metal similar properties to pressed metal. Spinning lines, however, often have a noticeable pattern in the metalware, unlike pressed metal.

## **IP rating**

An International Protection (IP) marking is a two digit code given to a product upon testing its ability to protect against liquid ingress and solid particles from entering the casing or frame of an object. Solids protection is rated from 0-6, where 0 is no protection and 6 is completely dust tight (no openings at all). Liquid ingress is rated from 0-8 where 0 is no protection and 8 is continuously immersible in water at least 1m deep.

## **Globe Holder**

The base of the fitting which is wired to allow a light source to attach. On pendants there is more than one globe holder, usually fitted to the end of each arm. Ceiling lanterns and float lamps may have clusters of three four or more globe holders, close to each other.

## **B22 (BC)**

A Bayonet Cap globe holder with a 22mm diameter. It is the most commonly used globe holder and globe base for fittings produced in Commonwealth nations including Australia.

## **B15 (SBC)**

A Small bayonet cap globe holder with only a 15mm base diameter. It is less common than the B22 (BC) and usually used in clusters for lanterns and float lamps to allow smaller globes to be closer together.

## **E27 (ES)**

An Edison Screw globe holder with a 27mm diameter, The standard European style globe holder, more common in our range of imported fittings.

## **E14 (SES)**

A smaller size edison screw globe holder (14mm diameter). Like the small bayonet globe holder, the SES is often used in clusters, and more commonly from imported fittings.

## **LED**

Light Emitting Diode, an energy efficient illuminating source, producing low amounts of heat, allowing for longer life spans and lower watts used per lumens output.

## **Incandescent**

A more traditional style of globe which is low in cost. A filament is burned to produce light, which is less efficient yet can be easily dimmed to suit intimate situations and at full strength, bright enough for task oriented situations like reading.



## **Electroplated**

A complex multi-stage process where a metal is bonded to the outside of another, typically brass in light fittings.

## **Powder Coated**

A durable, consistent dry painting process where metal is covered in a coloured powder and then heated to set the colour.

## **Chemically Treated**

A treatment process to brass which darkens the finish. Old brass, black bronze and antique bronze are finishes which we offer by preparing raw brass, then chemically treating it.

## **Size (Height)**

The total height of the fitting which is the sum of the suspension height, the fitting height and possibly the height of any shades if they extrude these dimensions. This calculation can be required to determine where back plates are used instead of a sliding canopy

## **Finish**

The final appearance of the metalware in a fitting, resulting from hand skilled processes to the metalware's surface. The majority of our fittings are made of brass, which can be processed in various finishes. The finish includes colour and reflectiveness and can greatly affect the aesthetics of the metalware. Our standard finishes are displayed and described throughout the catalogue.

Region	Order Amount (AUD)	Cost (AUD)	Shipping Method & Time (business days)
Adelaide.	\$ 500+	Free In Store	Same Day Local Delivery
SA, VIC, Sydney and Melbourne.	\$ 500+	Free In Store	Startrack Road Express 1-2 business days <sup>2</sup>
Brisbane, Perth and NSW.	\$ 500 - \$ 999 \$ 1000 +	\$ POA Free In Store	Startrack Road Express 3-5 business days <sup>2</sup>
WA, QLD, TAS and Hobart.	\$ 500 +	\$ POA	Startrack Road Express 5-10 business days <sup>2</sup>
Nation Wide	\$ 100 +	\$ 30 + GST	Startrack Air Premium 1 business day <sup>2</sup> Items under 5 Kg & Boxed no larger than 29cm <sup>3</sup>

Please allow for Assembly and Processing time. Built to order goods lead time varies by demand.

Pre-Assembled goods may take up to 2 days. All Items will be shipped together, no split deliveries will be made.



We only freight to commercial addresses, please ensure there will be someone available to receive your goods at your place of business,

We provide Startrack Express Pty Limited an Authority to Leave (ATL) for all consignments, so it is your responsibility to make sure someone from your organisation is able to receive goods between the hours of 09:00 - 17:00 local time, otherwise Startrack may leave goods in what they deem a safe and secure location on your premises.

\*This is an expected delivery time frame provided by Startrack, Actual Times may vary.

### 1. Definitions

In these terms “Company” means Robert Kitto Pty Ltd (ABN 58 008 210 526) and the “Customer” means the entity or person receiving goods and/or services from the Company.

### 2. Application of Terms

These terms govern the supply of goods and services by the Company to the Customer. They supersede all prior representations and agreements unless otherwise agreed in writing by the Company.

### 3. Delivery and Transportation

The Company will use its best efforts to supply goods or services by the date/s identified in accepted orders but does not represent or warrant that it will do so. The Company will arrange transportation of goods to the Customer at the Customers cost, unless agreed otherwise.

### 4. Return and Credits

No return of goods will be accepted unless the Company has previously agreed in writing. If the Company agrees to the return of goods, they must be delivered at the cost of the Customer to the Company’s premises.

### 5. Dispatch Errors, Shortages and Breakage

The Company will not be liable for dispatch errors, shortages and breakages unless they are reported to the Company by the Customer in writing within 48 hours of goods being delivered to the address nominated by the Customer.

### 6. Orders

Orders must be confirmed in writing by the Customer by either by fax or e-mail. The Company will not be liable for dispatch errors for orders placed by the Customer verbally.

### 7. Payment

The Customer must pay the amount invoiced including any Australian Goods and Services Tax (“GST”), without setoff, within 14 days from the end of the month in which the invoice is sent to the Customer. The Customer will pay interest on overdue amounts compounding daily, at an annual rate being the ATO GIC (Australian Taxation Office General Interest Charge rate for overdue payments) from the due date until the date of payment. In addition to interest a late payment fee of \$15+GST applies to cover the Company’s administrative costs. This fee will be charged once for each and every month that a Customer does not pay an invoiced amount in full. The Customer will be responsible for all costs incurred to recover the payment from the Customer on an indemnity basis.

### 8. Title

Title in goods passes to the Customer on payment in full for the goods. Until full payment is made, the Customer holds the goods as bailee for the Company. At any time before full payment is received, the Company may enter the premises of the Customer and take possession of the goods. If the Customer has sold goods for which the Company has not been paid in full, the Customer holds those proceeds on trust for the Company and will pay to the Company the proceeds of that sale.

### 9. Warranty and Liability

No warrant is given in respect of the supply or state, quality, condition or purpose of the use of any goods. The Company shall have no liability (including liability in negligence) to any person or entity for failure to supply or loss or damage consequential or otherwise suffered or incurred by any person in relation directly or indirectly to any defect, deficiency, failure or breakdown of any kind of the goods.

### 10. Force Majeure

Where an event or circumstance beyond the control of the Company occurs, which prevents the Company from complying with any of its obligations under these Terms of Trade, including but not limited to:-

- a force of nature;
- labour shortage;
- the temporary disconnection of power, internet and/or phone services; and
- any act or omission on the part of the Customer, its agents or employees.

The Company will not be considered in breach of these Terms of Trade or any contract between the parties to the extent that performance is prevented in these circumstances.

### **11. Customer Default**

In the event that:

a. The Customer fails to pay when due any amount owing to the Company or breaches any other provision of these terms;

b. The Customer ceases to be able to pay its debts as they become due or to carry on business;-

Then the Company may do any or all of the following (in addition to any other rights the Company may have):

i. Require the Customer to pay immediately all amounts invoiced or unpaid or to pay in advance of or on delivery of goods;

ii. Suspend or cease supplying goods and services to the Customer (whether or not the Customer has ordered goods or services that have not yet been supplied); and

iii. Enter the Customers premises and take possession of goods for which payment has not been made.

### **12. Cancellation of Order**

Any order placed with us may only be cancelled by the Customer with the written consent of the Company.

### **13. Export**

The Company has no liability for duties, taxes or other amounts charged or levied by third parties on the sale of goods outside of Australia. The Customer is responsible for ascertaining what duties or taxes may be payable and ensuring that they make payment in full of those duties and taxes.

### **14. Governing Law**

These Terms of Trade will be governed by and interpreted according to the laws of South Australia. Both parties agree to submit to the exclusive jurisdiction of South Australia.

### **15. Severance**

If any provision set out in these Terms of Trade is held to be invalid by a Court of law, the other remaining provisions will remain valid.

### **16. Variation of Terms of Trade**

These Terms of Trade may only be amended or varied by written agreement between the Customer and the Company.

### **17. Non-Assignment**

The Customer may not assign any of its rights or obligations under these Terms of Trade without the Company's prior written consent.

The Company's failure, delay or neglect to enforce a term of these Terms of Trade is not to be taken as a waiver of that term or the Company's rights, or a consent to, a waiver of, or any excuse for any different, continuing, or subsequent breach.

This policy explains how Robert Kitto Pty Ltd collect, store, use and disclose personal information that is provided to us through our operation as a business.

This policy explains our obligations to ensure the privacy of personal information and the steps we take to ensure that the information held by us is kept private.

Please read this policy carefully. Please contact us if you have any questions.

#### Types of personal information collected

Robert Kitto Pty Ltd collect various types of 'personal information' from clients and third parties.

Personal information is information that identifies or is likely to identify an individual. The types of personal information Robert Kitto Pty Ltd collect includes the following:

- Name
- Address
- Telephone number
- Email address
- Date of birth
- Bank account and credit card details

'Sensitive information' is personal information that includes information about racial or ethnic origin, political opinion, religious beliefs, membership to groups, sexual orientation, criminal records etc. If also includes health information or biometric information. Robert Kitto Pty Ltd do not usually collect this type of information in the course of their activity however this information may be collected from time to time inadvertently.

#### Collection and Storage of personal information

Where possible, Robert Kitto Pty Ltd collect personal information from you directly in the course of our business engagement, usually verbally or in writing.

Personal information is obtained indirectly where it is not practicable or possible to obtain the information from you. Information may be collected through documents, research or other people. We may also collect personal information from external professionals, suppliers, contractors or agents.

We only collect, store and disclose sensitive information where it is necessary for us to do so in order to provide our services to you and if you have consented to us doing so or as the law allows us to do so.

#### Data storage

We store all personal information within our office in physical format and electronically as appropriate.

We endeavour to keep all information safe by taking all reasonable steps to ensure the protection of information from misuse, loss, unauthorised access, modification or unauthorised disclosure.

#### Purposes for collecting, storing, using and disclosing personal information

We will only collect, store, use or disclose personal information where it is necessary for us to perform our services for you and in you have consented to the use of the personal information. There may be occasions where we are bound by law to collect and disclose personal information.

We collect, store, use or disclose personal information to:

- Provide our distribution and wholesale services;
- To communicate and contact you;
- To complete orders and deliveries;
- For internal record keeping;
- To provide quotes;
- To obtain the services of third parties;
- Where we are otherwise required or authorise to do so by law; and
- To otherwise run our business.

#### Disclosures

We may disclose personal information in the following circumstances:

- In the course of providing order and delivery information to third parties, such as couriers;
- To insurers;
- Others where you have provided us consent to do so.

We do not routinely disclose personal information overseas. We only disclose personal information overseas when it is specifically appropriate or relevant to providing our services for a particular customer or client.

In the event that we do have to disclose information, where it is lawful and appropriate, we ensure that the recipient is bound by an obligation of confidentiality.

We do not disclose any personal information (including your email address) to any third party for the purpose of allowing them to market their products or services to you (unless you have provided your prior express consent).

#### Client/Customer Rights and Access

You have the right to contact Robert Kitto Pty Ltd to correct and update any personal information we hold for you. If we refused to correct the information, we will provide you with a written notice of our refusal and how you can complain about the refusal.

Individuals have the right to contact Robert Kitto Pty Ltd to request what personal information about the individual is collected and how it is stored by Robert Kitto Pty Ltd.

Individuals have the right to contact Robert Kitto Pty Ltd to permit, consent or request to prohibit the use of personal information.

You can contact Robert Kitto Pty Ltd by writing to:

Robert Kitto Pty Ltd  
50 Richmond Road  
Keswick SA 5035

Or emailing:  
[info@robertkitto.com.au](mailto:info@robertkitto.com.au)

You can also call the office between 10:30 – 16:00 (ACST) on +61 8 8297 4122 Monday to Friday.

Notes:

Notes:



Notes: