

# *Lighting Inspirations*

***DESIGNER COLLECTION***

***- Circa 1965 -***

## *Catalogue 2021/22*



***“Be  
Inspired  
And  
Discover  
The  
Difference”***

***Call - 03 - 9486 4115 Fax - 03 - 9486 4246***

***Email - [lodelighting@bigpond.com](mailto:lodelighting@bigpond.com) Website - [www.lightinginspirations.com.au](http://www.lightinginspirations.com.au)***

***Showroom/Office - 301/317 Rae Street Fitzroy North Vic 3068 - P.O Box- 1198 Fitzroy North Victoria 3068 Australia***

# Carter-Keys & Spacey Range



1000132

**CARTER  
LARGE  
CHROME  
OPAL**  
E27  
FRAME SIZE -  
H - 37cm  
W - 35cm



1000133

**CARTER  
SMALL  
CHROME  
OPAL**  
E27  
FRAME SIZE -  
H - 30cm  
W - 28cm



1001247

**SPACEY  
LARGE  
CHROME  
CLEAR**  
E27  
FRAME SIZE -  
H - 42cm  
W - 35cm



1001248

**SPACEY  
SMALL  
CHROME  
CLEAR**  
E27  
FRAME SIZE -  
H - 36cm  
W - 25cm

*- NOTE -  
-  
Supplied  
With  
LMT  
Chain  
&  
Canopy  
-*



1001245

**KEYS  
LARGE  
CHROME  
CLEAR**  
E27  
FRAME SIZE -  
H - 50cm  
W - 40cm

*- NOTE -  
-  
Supplied  
With  
LMT  
Chain  
&  
Canopy  
-*

## Classic Hampton Style Glassware Pendant



1001246

**KEYS  
SMALL  
CHROME  
CLEAR**  
E27  
FRAME SIZE -  
H - 41cm  
W - 30cm

*Globes  
Not  
Supplied*

*Jefferson  
Bronze  
&  
Chrome  
Range*

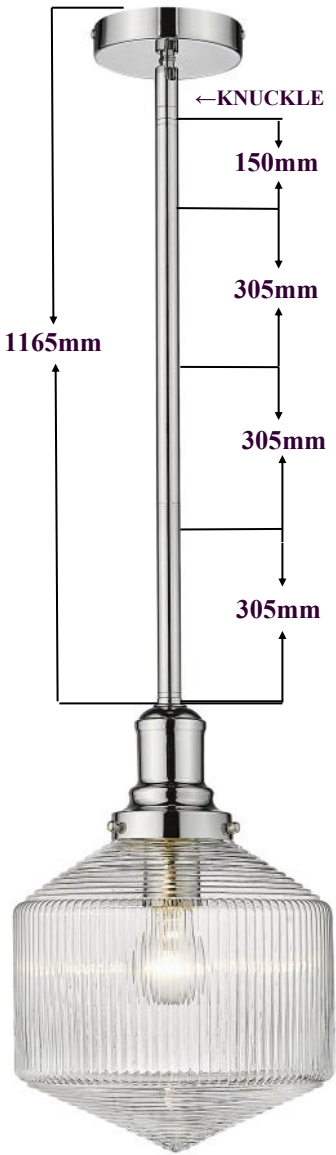

**1001252**  
**JEFFERSON  
 SMALL  
 CHROME  
 CLEAR**  
 E27  
 FRAME SIZE -  
 H - 39cm  
 W - 25cm



**1001250**  
**JEFFERSON  
 SMALL  
 BRONZE  
 OPAL**  
 E27  
 FRAME SIZE -  
 H - 39cm  
 W - 25cm  
 RODS AS PER  
 SMALL



**1001249**  
**JEFFERSON  
 LARGE  
 BRONZE  
 OPAL**  
 E27  
 FRAME SIZE -  
 H - 49cm  
 W - 35cm  
 RODS AS PER  
 SMALL

*Classic  
 Industrial Style  
 Glassware  
 Pendant*

*In Built  
 Angle  
 Canopy*

**1001251**  
**JEFFERSON  
 LARGE  
 CHROME  
 CLEAR**  
 E27  
 FRAME SIZE -  
 H - 49cm  
 W - 35cm  
 RODS AS PER  
 SMALL



*Globes  
 Not  
 Supplied*

**Gatsby  
Bronze  
&  
Chrome  
Range**

**- NOTE -**  
-  
**Supplied  
With  
1MT  
Chain  
&  
Canopy**  
-



**1000220**  
**GATSBY  
PND SMALL  
CHROME**  
**E27**  
**FRAME SIZE -**  
H - 40cm  
W - 27cm



**1000221**  
**GATSBY  
PND SMALL  
BRONZE**  
**E27**  
**FRAME SIZE -**  
H - 40cm  
W - 27cm



**1000218**  
**GATSBY  
PND LARGE  
CHROME**  
**E27**  
**FRAME SIZE -**  
H - 50cm  
W - 42cm



**1000236**  
**GATSBY W/B  
CHROME**  
**B22**  
**FRAME SIZE -**  
H - 20cm W - 14cm  
P - 13cm



**1000235**  
**GATSBY W/B  
BRONZE**  
**B22**  
**FRAME SIZE -**  
H - 20cm W - 14cm  
P - 13cm



**1000219**  
**GATSBY  
PND LARGE  
BRONZE**  
**E27**  
**FRAME SIZE -**  
H - 50cm  
W - 42cm

**Classic  
Industrial Style  
Glassware  
Pendant**

*Globes  
Not  
Supplied*

**Stockton  
Chrome  
Range**

1000474

**STOCKTON  
CHAIN  
MEDIUM 1/LT  
CHROME**  
E27  
FRAME SIZE  
WITHOUT CHAIN  
H - 26cm  
W - 31cm



**Note-**  
For Semi Flush  
Version  
Insert Top Flush  
Plate Here  
For  
All 3 Sizes

1000476

**STOCKTON  
CHAIN  
SMALL 1/LT  
CHROME**  
E27  
FRAME SIZE  
WITHOUT CHAIN  
H - 21cm  
W - 26cm



1000472

**STOCKTON  
CHAIN  
LARGE 1/LT  
CHROME**  
E27  
FRAME SIZE  
WITHOUT CHAIN  
H - 33cm  
W - 43cm



**- NOTE -**

**-  
Supplied  
With  
1 MT  
Chain  
&  
Canopy  
-**

**Globes  
Not  
Supplied**

**Buster  
Bronze  
&  
Chrome  
Range**

1000077

**BUSTER  
STANDARD  
RECESSED  
LAMP  
HOLDER  
CLOTH  
BLACK  
CORD  
SUSP  
BRONZE  
B22**



1000076

**BUSTER  
STANDARD  
RECESSED  
LAMP  
HOLDER  
CLOTH  
BLACK  
CORD  
SUSP  
CHROME  
B22**



1000078

**BUSTER  
1/LT  
RECESSED  
WB  
BRONZE  
B22**

**FRAME SIZE -  
Without globe-  
H - 12cm  
W - 9cm  
P - 7cm**



1000079

**BUSTER  
1/LT  
RECESSED  
WB  
CHROME  
B22**

**FRAME SIZE -  
Without globe-  
H - 12cm  
W - 9cm  
P - 7cm**



**- NOTE -  
-  
Supplied  
With  
1 MT  
Cloth  
Cord  
-**

**Globes  
Not  
Supplied**

# Raze Bronze Range

1001401

**RAZE  
CORD PND 1/LT  
BRONZE**  
E27  
FRAME SIZE  
H - 16cm W - 40cm

*NOTE -  
Supplied  
With A  
1  
Meter  
Cloth Cord  
Drop.*

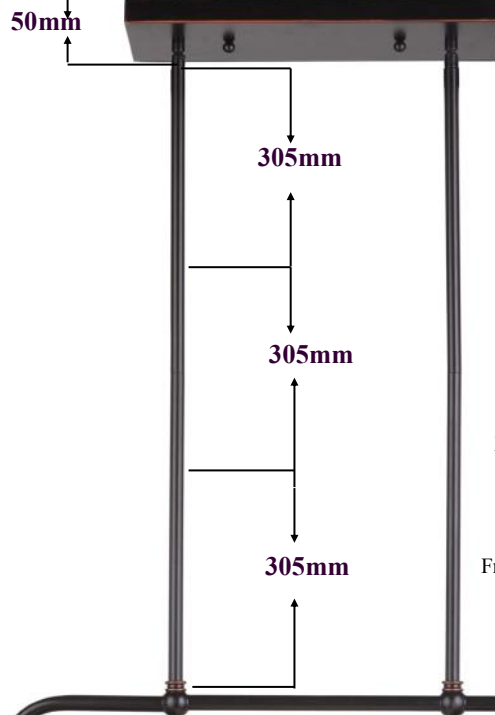

1001404

**RAZE  
2/LT BENCH PND  
BRONZE**  
E27  
FRAME SIZE  
H - 24cm  
From Shade To Rod Joiner  
W - 35cm L - 93cm

1001403

**RAZE  
ROD PND 1/LT  
BRONZE**  
E27  
FRAME SIZE  
H - 16cm  
W - 40cm

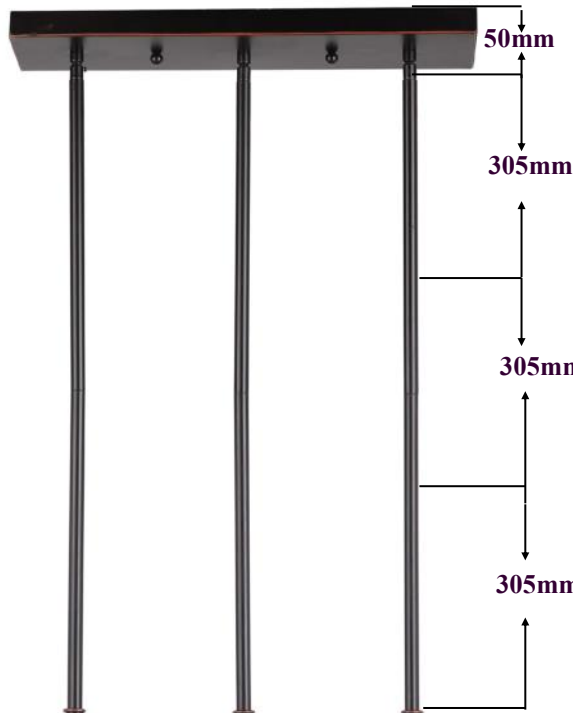
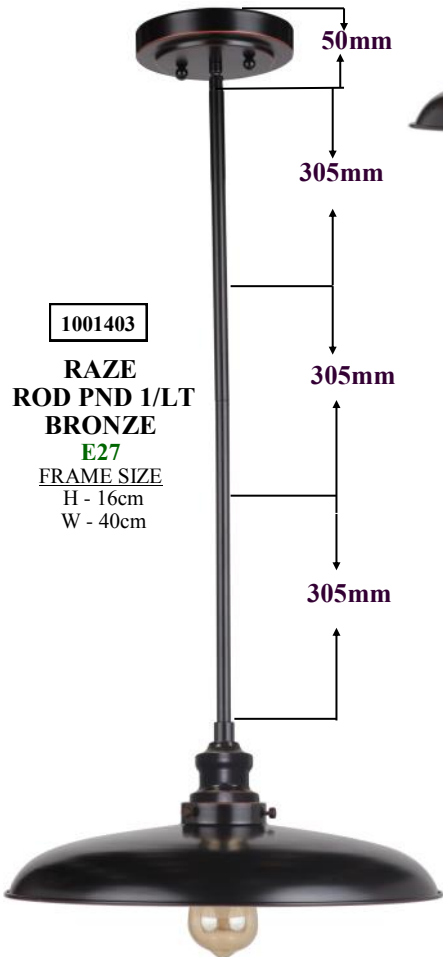

1001406

**RAZE  
3/LT BENCH PND  
BRONZE**  
E27  
FRAME SIZE  
H - 24cm  
From Shade To Rod Joiner  
W - 35cm L - 124cm



***Futura  
Range***



***VANITY  
WALL  
BRACKETS***



1000216

**FUTURA 1/LT W/B CHROME E27**  
FRAME SIZE - H - 23cm W - 17cm P - 15cm



1000217

**FUTURA 2/LT W/B CHROME E27**  
FRAME SIZE - H - 23cm W - 45cm P - 15cm

***VANITY  
WALL  
BRACKETS***

***Dover  
Range***



***Dover  
1/LT W/B  
&  
2/LT W/B  
Can Be  
Installed Either  
Facing Up  
Or  
Facing Down***



1001253

**DOVER 1/LT W/B CHROME E27**  
FRAME SIZE - H - 20cm W - 12cm P - 15cm



1001254

**DOVER 2/LT W/B CHROME E27**  
FRAME SIZE - H - 20cm W - 37cm P - 16cm





**VANITY  
WALL  
BRACKETS**

1001255

**MONROE 1/LT W/B BRONZE E27**  
FRAME SIZE - H - 24cm W - 15cm P - 19cm



**Monroe  
Range**



1001257

**MONROE 2/LT W/B BRONZE E27**  
FRAME SIZE - H - 24cm W - 38cm P - 19cm



**Monroe  
1/LT W/B  
&  
2/LT W/B  
Can Be Installed  
Facing Up  
Or  
Facing Down**

1001256

**MONROE 1/LT W/B CHROME E27**  
FRAME SIZE - H - 24cm W - 15cm P - 19cm



**VANITY  
WALL  
BRACKETS**



1001258

**MONROE 2/LT W/B CHROME E27**  
FRAME SIZE - H - 38cm W - 24cm P - 19cm



**Nova  
Range**

**VANITY  
WALL BRACKETS**



1001372

**NOVA 1/LT W/B  
BRONZE E27**

FRAME SIZE -  
H - 23cm W - 15cm P - 21cm

1001371

**NOVA 3/LT SEMI FLUSH BRONZE E27**

FRAME SIZE - H - 34cm W - 41cm



1001373

**NOVA  
2/LT W/B  
BRONZE  
E27**

FRAME SIZE  
H - 23cm  
W - 42cm  
P - 22cm



**Nova - 1/LT W/B & 2/LT W/B  
Can Be Installed Either  
Facing Up Or Facing Down**

**VANITY  
WALL BRACKETS**



1001375

**NOVA 1/LT W/B  
CHROME E27**

FRAME SIZE -  
H - 23cm W - 15cm P - 21cm

1001374

**NOVA 3/LT SEMI FLUSH CHROME E27**

FRAME SIZE - H - 34cm W - 41cm



1001376

**NOVA  
2/LT W/B  
CHROME  
E27**

FRAME SIZE  
H - 23cm  
W - 42cm  
P - 22cm



**VANITY  
WALL  
BRACKETS**

**Rockford  
Range**



**1001428**

**ROCKFORD  
2/LT W/B  
CHROME  
E14  
FRAME SIZE**  
H - 41cm  
W - 12cm  
P - 11cm



**1001108**

**CHESTER 2/LT W/B CHROME E27**  
**FRAME SIZE -**  
H - 37cm W - 12cm P - 11cm



**1001107**

**CHESTER  
1/LT W/B  
CHROME  
E27  
FRAME SIZE**  
H - 25cm  
W - 12cm  
P - 11cm



**Chester  
Range**

**New**



**1001109**

**CHESTER 2/LT W/B MATT BLACK E27**  
**FRAME SIZE -**  
H - 37cm W - 12cm P - 11cm



**1001106**

**CHESTER  
1/LT W/B  
MATT  
BLACK  
E27  
FRAME SIZE**  
H - 25cm  
W - 12cm  
P - 11cm

**Chester  
Range**

**New**



**Manor  
Chrome  
Range**

**\*Features\*  
Classic  
Hampton  
&  
Provincial  
Style**

**1000411**

**MANOR  
LARGE  
4/LT PND  
CHROME  
E14**

**FRAME SIZE -  
H-57cm W-30cm**

**- NOTE -**

**Supplied  
With  
1 MT  
Chain  
&  
Canopy**

**- NOTE -**

**Supplied  
With  
1 MT  
Chain  
&  
Canopy**

**1000410**

**MANOR  
MEDIUM  
3/LT PND  
CHROME  
E14**

**FRAME SIZE -  
H-48cm W-25cm**



**Curved  
Panel  
Glassware**

**Globes  
Not  
Supplied**



1000583

MANOR  
MEDIUM  
3/LT PND  
BRONZE  
E14  
FRAME SIZE -  
H-48cm W-25cm

- NOTE -

-  
Supplied  
With  
1 MT  
Chain  
&  
Canopy  
-

Globes  
Not  
Supplied

*Curved  
Panel  
Glassware*

*\*Features\*  
Classic  
Hampton  
&  
Provincial  
Style*

*Manor  
Bronze  
Range*



1000585

MANOR  
LARGE  
4/LT PND  
BRONZE  
E14  
FRAME SIZE -  
H-57cm W-30cm

- NOTE -

-  
Supplied  
With  
1 MT  
Chain  
&  
Canopy  
-

**Montana  
Chrome  
Range**

1000333

MONTANA  
LANTERN  
MEDIUM  
4/LT  
CHROME  
E14  
FRAME SIZE  
H - 72cm W - 38cm

*- NOTE -  
-  
Supplied  
With  
1 MT  
Chain  
&  
Canopy  
-*

*Globes  
Not  
Supplied*

*\*Features\*  
Classic  
Hampton  
&  
Provincial  
Style*

1000335

MONTANA  
LANTERN  
SMALL  
3/LT  
CHROME  
E14  
FRAME SIZE  
H - 59cm W - 27cm

*Lanterns  
Feature  
Clear  
Beveled  
Glassware*

**Montana  
Bronze  
Range**

*Globes  
Not  
Supplied*

*\*Features\*  
Classic  
Hampton  
&  
Provincial  
Style*

*- NOTE -  
-  
Supplied  
With  
IMT  
Chain  
&  
Canopy  
-*

1000336

**MONTANA  
LANTERN  
SMALL  
3/LT  
BRONZE  
E14  
FRAME SIZE  
H - 59cm W - 27cm**

1000334

**MONTANA  
LANTERN  
MEDIUM  
4/LT  
BRONZE  
E14  
FRAME SIZE  
H - 72cm W - 38cm**



*Lanterns  
Feature  
Clear  
Beveled  
Glassware*

**Michigan  
Chrome  
Range**

1000327

MICHIGAN  
LANTERN  
MEDIUM  
3/LT  
CHROME  
E14  
FRAME SIZE  
H - 60cm W - 28cm

- NOTE -

Supplied  
With  
1 MT  
Chain  
&  
Canopy

Globes  
Not  
Supplied

1000329

MICHIGAN  
LANTERN  
SMALL  
1/LT  
CHROME  
E27  
FRAME SIZE  
H - 49cm W - 20cm

*\*Features\*  
Classic  
Hampton  
&  
Provincial  
Style*



*Lanterns  
Feature  
Clear  
Beveled  
Glassware*



**Michigan  
Bronze  
Range**

*Globes  
Not  
Supplied*

*- NOTE -  
-  
Supplied  
With  
1 MT  
Chain  
&  
Canopy  
-*

1000330

**MICHIGAN  
LANTERN  
SMALL  
1/LT  
BRONZE**

**E27**

FRAME SIZE  
H - 49cm W - 20cm

1000328

**MICHIGAN  
LANTERN  
MEDIUM  
3/LT  
BRONZE**

**E14**

FRAME SIZE  
H - 60cm W - 28cm

*\*Features\*  
Classic  
Hampton  
&  
Provincial  
Style*



*Lanterns  
Feature  
Clear  
Beveled  
Glassware*



**Tyson  
Range**

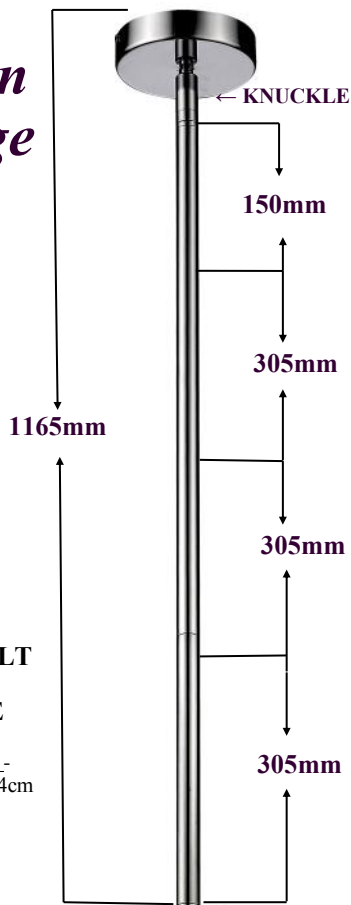

**1001261**  
**TYSON**  
**MEDIUM 4/LT**  
**PND**  
**CHROME**  
**E14**  
 FRAME SIZE -  
 H - 38cm W - 44cm



**1001260**  
**TYSON**  
**MEDIUM 4/LT SEMI FLUSH**  
**CHROME E14**  
 FRAME SIZE -  
 H - 38cm W - 44cm



*Globes  
Not  
Supplied*

**1001262**

**TYSON**  
**SMALL 3/LT PND**  
**CHROME E14**  
 FRAME SIZE -  
 H - 36cm W - 27cm  
 RODS & KNUCKLE  
 AS PER  
 MEDIUM



**1001259**  
**TYSON**  
**SMALL 3/LT**  
**SEMI FLUSH**  
**CHROME E14**  
 FRAME SIZE -  
 H - 36cm W - 27cm



# Oregon Chrome Range

**1000676**  
**OREGON  
 LANTERN  
 MEDIUM  
 1/LT  
 CHROME**  
 E27  
 FRAME SIZE  
 H - 47cm W - 40cm

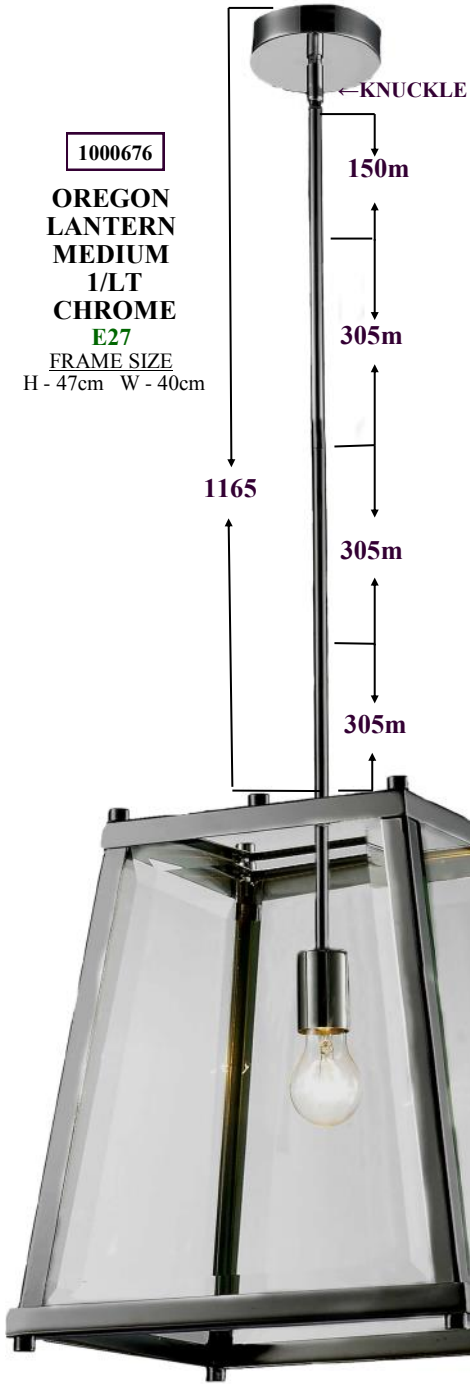

**1000677**  
**OREGON  
 C.T.C SMALL  
 1/LT CHROME**  
 E27  
 FRAME SIZE  
 H - 34cm W - 27cm

*Globes  
 Not  
 Supplied*

**1000678**  
**OREGON  
 LANTERN  
 SMALL  
 1/LT  
 CHROME**  
 E27  
 FRAME SIZE  
 H - 30cm W - 27cm  
 RODS & KNUCKLE  
 AS PER  
 MEDIUM



*Lanterns  
 Feature  
 Clear  
 Beveled  
 Glassware*

**1000679**  
**OREGON  
 BENCH  
 4/LT  
 CHROME**  
 E27  
 FRAME SIZE  
 H - 27cm W - 30cm  
 L - 78cm

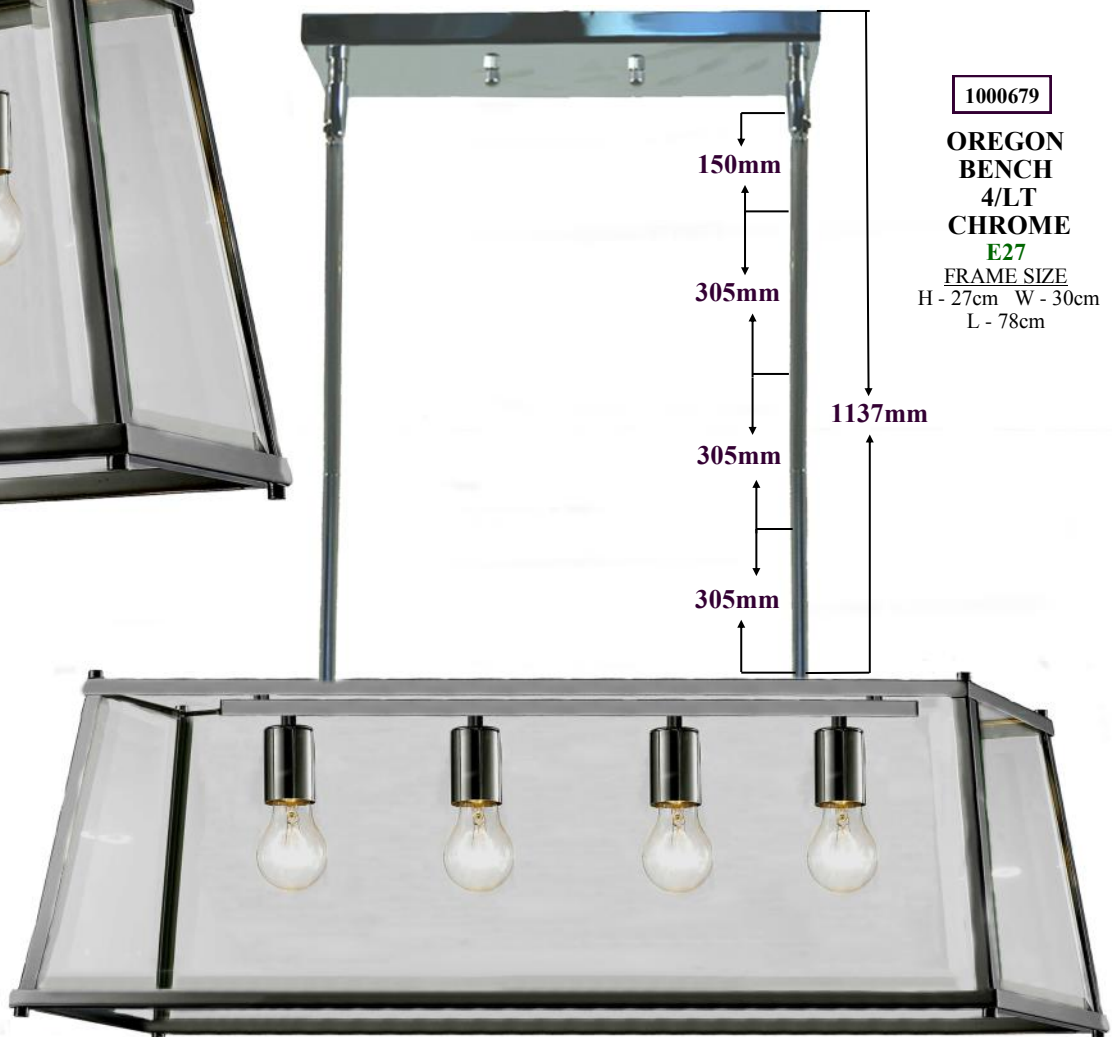

**Rutherford  
Bronze  
Range**

**\*Features\*  
Curved  
Panel  
Glassware**

**\*Features\*  
Classic  
Hampton  
&  
Provincial  
Style**

**1000430**

**RUTHERFORD  
LARGE  
6/LT PND  
BRONZE  
E14  
FRAME SIZE  
H - 65cm W - 40cm  
L - 60cm  
RODS & KNUCKLE  
AS PER  
SMALL**

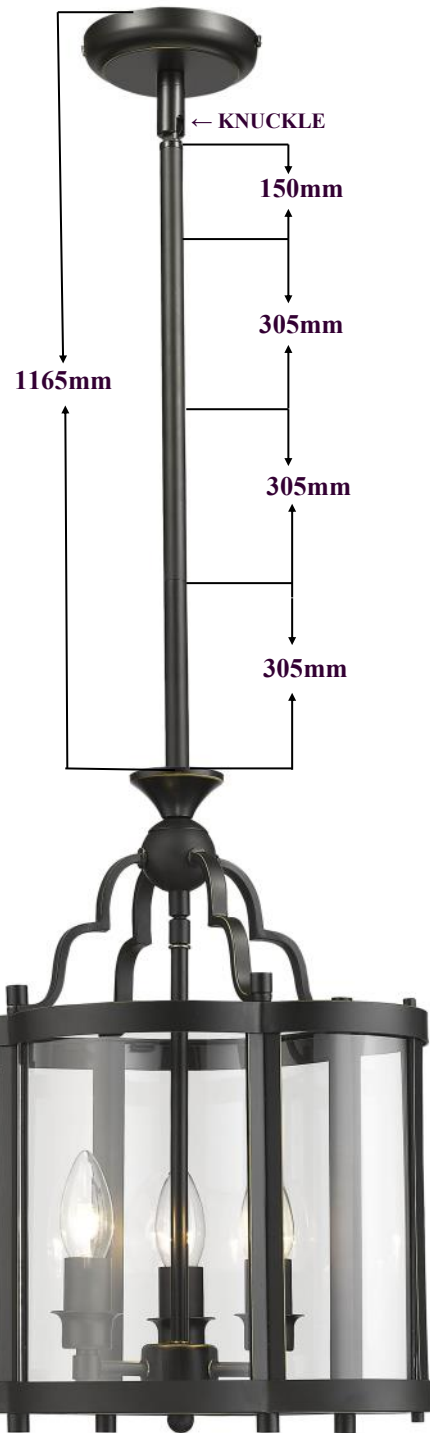

**1000431**

**RUTHERFORD  
SMALL  
3/LT PND  
BRONZE  
E14  
FRAME SIZE  
H - 46cm W - 24cm  
L - 32cm**

**Globes  
Not  
Supplied**

*\*Features\**  
*Clear*  
*Beveled*  
*Glassware*

*Country*  
*Bronze*  
*Range*

1000121

**COUNTRY  
LANTERN  
LARGE  
4/LT  
BRONZE**  
E14  
FRAME SIZE  
H - 80cm  
W - 47cm



1000123

**COUNTRY  
LANTERN  
SMALL  
1/LT  
BRONZE**  
E27  
FRAME SIZE  
H - 55cm  
W - 30cm



1000122

**COUNTRY  
LANTERN  
MEDIUM  
3/LT  
BRONZE**  
E14  
FRAME SIZE  
H - 62cm  
W - 37cm



*- NOTE -*  
*-*  
*Supplied*  
*With*  
*1 MT*  
*Chain*  
*&*  
*Canopy*  
*-*

**Carrington  
Bronze  
Range**

1000092

**CARRINGTON  
MEDIUM  
4/LT PND  
BRONZE  
E14**  
FRAME SIZE  
H - 72cm W - 30cm



1000093

**CARRINGTON  
SMALL  
3/LT PND  
BRONZE  
E14**  
FRAME SIZE  
H - 62cm W - 24cm



1000091

**CARRINGTON  
LARGE  
6/LT PND  
BRONZE  
E14**  
FRAME SIZE  
H - 92cm W - 38cm



**- NOTE -**  
-  
Supplied  
With  
1 MT  
Chain  
&  
Canopy  
-

*Globes  
Not  
Supplied*

***\*Features\****  
***Clear***  
***Water Drop***  
***Effect***  
***Glassware***

# Summit Chrome Range

*New*

*Globes  
Not  
Supplied*



1001480

**SUMMIT  
1/LT W/B CHROME**  
E27  
FRAME SIZE -  
H - 23cm W - 15cm  
P - 19cm



1001484

**SUMMIT  
ROD SET  
CHROME**  
E27  
FRAME  
SIZE  
H - 9cm  
W - 7cm  
**NOTE-**  
ROD  
LENGTHS  
3 x 40cm  
1 x 30cm  
CANOPY  
SIZE  
H - 5cm  
W - 12cm  
**NOTE-**  
TO SUIT  
ANY  
GLASS  
WITH  
HOLE SIZE  
42mm  
TO  
50mm



1001481

**SUMMIT  
2/LT W/B CHROME**  
E27  
FRAME SIZE -  
H - 23cm W - 40cm  
P - 21cm



1001483

**SUMMIT  
5/LT PND  
CHROME**  
E27  
FRAME SIZE  
H - 22cm W - 50cm  
**NOTE-**  
CANOPY SIZE  
H - 5cm  
W - 12cm  
RODS  
AS PER  
3LT PND



1001485

**SUMMIT  
1/LT PND CHROME**  
E27  
FRAME SIZE  
H - 18cm W - 15cm  
**NOTE-**  
CANOPY SIZE  
H - 5cm W - 12cm



1001482

**SUMMIT  
3/LT PND  
CHROME**  
E27  
FRAME SIZE  
H - 22cm  
W - 47cm  
**NOTE-**  
CANOPY SIZE  
H - 5cm  
W - 12cm

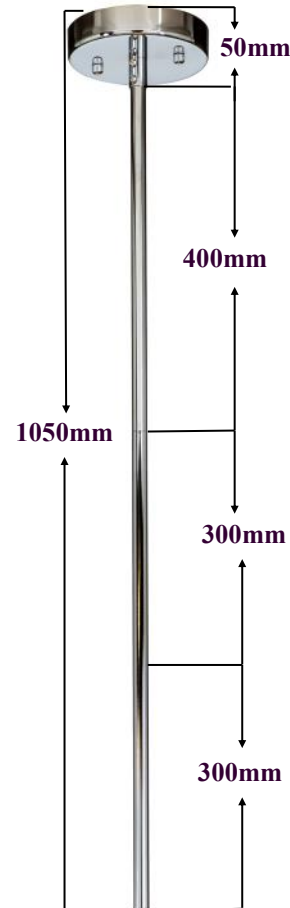

**Lakewood**     *New*  
**Bronze**  
**Range**

1001296

**LAKWOOD**  
**SEMI FLUSH**  
**4/LT PND**  
**BRONZE**

**E14**  
**FRAME SIZE**  
H - 32cm W - 44cm



1001297

**LAKWOOD**  
**SUSPENSION**  
**4/LT PND**  
**BRONZE**

**E14**  
**FRAME SIZE**  
H - 62cm W - 54cm



*- NOTE -*  
 -  
*Supplied*  
*With*  
1MT  
Chain  
 &  
Canopy  
 -

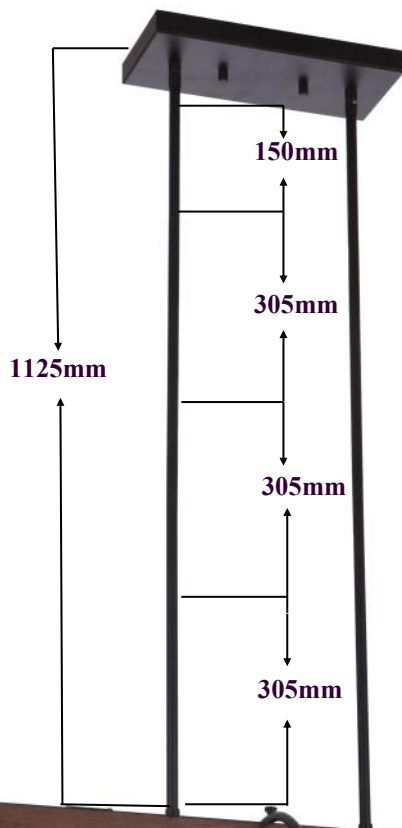

1001293

**LAKWOOD**  
**BENCH**  
**4/LT PND**  
**BRONZE**

**E27**  
**FRAME SIZE**  
H - 27cm W - 31cm  
L - 87cm



*Globes*  
*Not*  
*Supplied*



*New* **Lakewood  
Bronze  
Range**



**1001292**  
**LAKWOOD**  
**3/LT PND**  
**BRONZE**  
**E14**  
 FRAME SIZE  
 H - 56cm W - 54cm

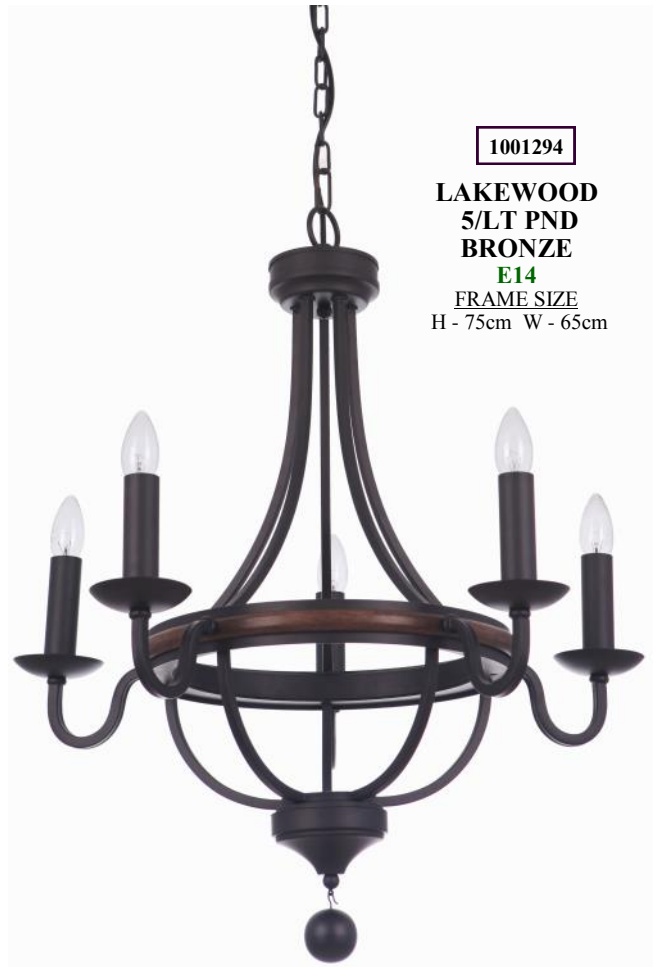

**1001294**  
**LAKWOOD**  
**5/LT PND**  
**BRONZE**  
**E14**  
 FRAME SIZE  
 H - 75cm W - 65cm

**- NOTE -**  
 -  
*Supplied  
 With  
 1 MT  
 Chain  
 &  
 Canopy*  
 -



**1001295**  
**LAKWOOD**  
**8/LT PND**  
**BRONZE**  
**E14**  
 FRAME SIZE  
 H - 97cm W - 80cm

*Globes  
 Not  
 Supplied*



**1001291**  
**LAKWOOD**  
**1/LT W/B**  
**BRONZE**  
**E14**  
 FRAME SIZE  
 H - 19cm W - 13cm  
 P - 16cm

**Dalton  
Range**

**New**

**\*Features\***  
Cognac  
Shape  
Clear  
Glassware

Globes  
Not  
Supplied

**1001144**  
**DALTON  
3/LT PND  
MATT BLACK**  
E27  
FRAME SIZE  
H - 30cm W - 42cm  
RODS & KNUCKLE  
AS PER  
5/LT PENDANT

**1001145**  
**DALTON  
5/LT PND  
MATT BLACK**  
E27  
FRAME SIZE  
H - 41cm W - 60cm

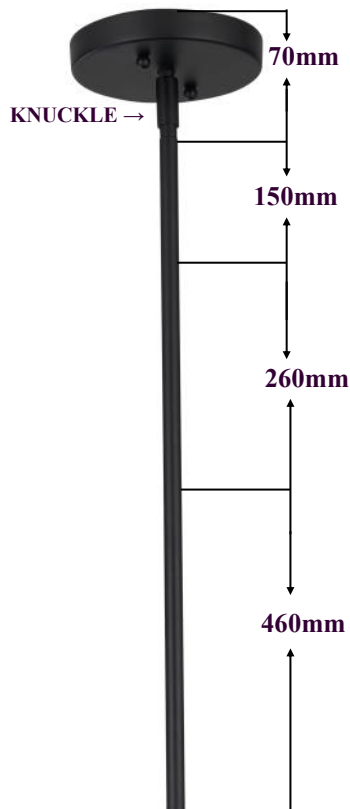

**1001143**  
**DALTON  
1/LT W/B  
MATT BLACK**  
E27  
FRAME SIZE  
H - 32cm W - 13cm  
P - 17cm



*New*

# Aspen Range

*Globes  
Not  
Supplied*

1001065

**ASPEN  
5/LT PND  
MATT BLACK**  
E27  
FRAME SIZE  
H - 28cm W - 70cm  
RODS & KNUCKLE  
AS PER  
3/LT PENDANT

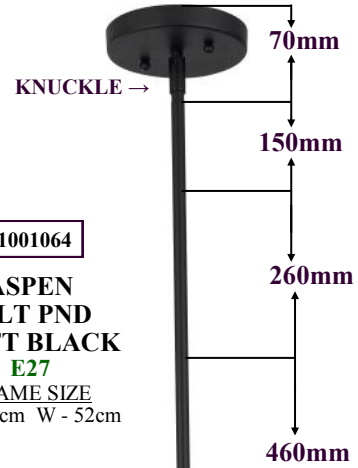

1001064

**ASPEN  
3/LT PND  
MATT BLACK**  
E27  
FRAME SIZE  
H - 28cm W - 52cm



1001062

**ASPEN  
1/LT W/B  
MATT BLACK**  
E27  
FRAME SIZE  
H - 29cm W - 20cm  
P - 23cm



1001063

**ASPEN BENCH  
3/LT PND  
MATT BLACK**  
E27  
FRAME SIZE  
H - 23cm W - 20cm  
L - 84cm  
RODS & KNUCKLE  
AS PER  
3/LT PENDANT



# Hilton Range

*New*



1001224

**HILTON  
1/1T W/B  
CHROME**

**E14**

FRAME SIZE

H - 32cm W - 14cm  
P - 19cm



1001225

**HILTON  
2/1T W/B  
CHROME**

**E14**

FRAME SIZE

H - 32cm W - 33cm  
P - 18cm

- NOTE -

-  
Supplied  
With  
1 MT  
Chain  
&  
Canopy  
-

*\*Features\*  
Classic  
Hampton  
Style*

1001223

**HILTON  
12/1T PND  
CHROME**

**E14**

FRAME SIZE

H - 69cm W - 80cm



# Hilton Range

*New*

1001227

**HILTON  
5/LT PND  
CHROME**

**E14**

FRAME SIZE

H - 50cm W - 64cm



1001226

**HILTON  
3 /LT PND  
CHROME**

**E14**

FRAME SIZE

H - 45cm W - 48cm



- NOTE -

-  
Supplied  
With  
1 MT  
Chain  
&  
Canopy  
-

*\*Features\*  
Classic  
Hampton  
Style*

1001228

**HILTON  
8/LT PND  
CHROME**

**E14**

FRAME SIZE

H - 55cm W - 81cm



**Pittsburgh** *New*  
**Bronze**  
**Range**



1001382

**PITTSBURGH**  
**1/LT PW/B**  
**BRONZE**

**E27**

FRAME SIZE

H - 20cm W - 19cm  
P - 24cm

*\*Features\**  
*White*  
*Alabaster*  
*Glass*

*\*Features\**  
*Classic*  
*Provincial*  
*Style*

*- NOTE -*  
*-*  
*Supplied*  
*With*  
*1 MT*  
*Chain*  
*&*  
*Canopy*  
*-*

*\*Features\**  
*Classic*  
*Hampton*  
*&*  
*Provincial*  
*Style*

1001385

**PITTSBURGH**  
**9/LT PND**  
**BRONZE**

**E27**

FRAME SIZE

H - 79cm W - 90cm

*Globes*  
*Not*  
*Supplied*



*New* **Pittsburgh  
Bronze  
Range**

1001386

**PITTSBURGH  
SUSPENSION  
3/LT PND  
BRONZE**  
E27  
FRAME SIZE  
H - 45cm W - 45cm

*- NOTE -*  
-  
Supplied  
With  
1 MT  
Chain  
&  
Canopy  
-



*Globes  
Not  
Supplied*

1001384

**PITTSBURGH  
5/LT PND  
BRONZE**  
E27  
FRAME SIZE  
H - 56cm W - 65cm



*- NOTE -*  
-  
Supplied  
With  
1 MT  
Chain  
&  
Canopy  
-

*\*Features\**  
*White  
Alabaster  
Glass*

*\*Features\**  
*Classic  
Hampton  
&  
Provincial  
Style*

1001383

**PITTSBURGH  
3/LT PND  
BRONZE**  
E27  
FRAME SIZE  
H - 43cm W - 53cm



**Dallas  
Bronze  
Range**

1000127

**DALLAS BRONZE  
5/LT PND**  
E27  
FRAME SIZE -  
H - 68cm W - 60cm



Canopy  
Supplied

1000125

**DALLAS BRONZE  
3/LT PND**  
E27  
FRAME SIZE -  
H - 61cm W - 45cm



*\*Features\*  
Classic  
Hampton  
&  
Provincial  
Style*

- NOTE -  
-  
Supplied  
With  
1 MT  
Chain  
&  
Canopy  
-



1000129

**DALLAS BRONZE  
6/LT + 3/LT = 9/LT PND**  
E27  
FRAME SIZE -  
H - 79cm W - 75cm



1000141

**DALLAS BRONZE**  
**1/LT W/B**  
**E27**  
FRAME SIZE  
H - 24cm W - 15cm  
P - 21cm



*Dallas  
Bronze  
Range*



1000135

**DALLAS BRONZE**  
**SEMI FLUSH 2/LT E27**  
FRAME SIZE - H - 34cm W - 39cm

*OYSTER  
&  
W/B  
SHOWN  
WITH  
LIGHTS ON*



1000131

**DALLAS BRONZE**  
**3/LT OYSTER E27**  
FRAME SIZE - H - 19cm W - 41cm

**DALLAS BRONZE**  
**SINGLE SUSPENSION**  
**3/LT E27**  
FRAME SIZE -  
H - 63cm W - 40cm



*- NOTE -*  
*-*  
*Supplied*  
*With*  
*1MT*  
*Chain*  
*&*  
*Canopy*  
*-*

**Dallas  
Chrome  
Range**

1000126

DALLAS CHROME  
5/LT PND

E27  
FRAME SIZE -  
H - 68cm W - 60cm



Canopy  
Supplied

1000124

DALLAS CHROME  
3/LT PND

E27  
FRAME SIZE -  
H - 61cm W - 45cm



*\*Features\*  
Classic  
Hampton  
&  
Provincial  
Style*

- NOTE -

-  
Supplied  
With  
1MT  
Chain  
&  
Canopy  
-



1000128

DALLAS CHROME  
6/LT + 3/LT = 9/LT PND

E27  
FRAME SIZE -  
H - 79cm W - 75cm

1000140

**DALLAS CHROME**  
**1/LT W/B**  
**E27**  
FRAME SIZE  
H - 24cm W - 15cm  
P - 21cm



# Dallas Chrome Range



1000134

**OYSTER  
&  
W/B  
SHOWN  
WITH  
LIGHTS ON**

**DALLAS CHROME**  
**SEMI FLUSH 2/LT E27**  
FRAME SIZE - H - 34cm W - 39cm

**- NOTE -**

**-  
Supplied  
With  
IMT  
Chain  
&  
Canopy  
-**



1000130

**DALLAS CHROME**  
**3/LT OYSTER E27**  
FRAME SIZE - H - 19cm W - 41cm



1000138

**DALLAS CHROME**  
**SINGLE SUSPENSION**  
**3/LT E27**  
FRAME SIZE -  
H - 63cm W - 40cm

*Houston  
Bronze  
Range*

1000254

**HOUSTON  
5/LT PND  
BRONZE**

**E27**

**FRAME SIZE -  
H - 59cm W - 58cm**



1000250

**HOUSTON  
3/LT PND  
BRONZE**

**E27**

**FRAME SIZE -  
H - 49cm W - 44cm**



**- NOTE -**

**Supplied  
With  
1 MT  
Chain  
&  
Canopy**

1000255

**HOUSTON  
6+3 = 9/LT PND  
BRONZE**

**E27**

**FRAME SIZE -  
H - 76cm W - 66cm**



*Houston  
Bronze  
Range*



**1000264**  
**HOUSTON  
1/LT W/B  
BRONZE**  
**E27**  
**FRAME SIZE**  
 H - 23cm  
 W - 18cm  
 P - 24cm



**1000258**  
**HOUSTON  
SEMI FLUSH  
2/LT BRONZE**  
**E27**  
**FRAME SIZE -**  
 H - 39cm W - 33cm

*Features  
Opal  
Matt  
Glassware*



**1000262**  
**HOUSTON  
SINGLE  
SUSPENSION  
2/LT  
BRONZE**  
**E27**  
**FRAME SIZE -**  
 H - 57cm W - 33cm

*- NOTE -  
-  
Supplied  
With  
1MT  
Chain  
&  
Canopy  
-*



**1000248**  
**HOUSTON  
3/LT FLUSH  
BRONZE**  
**E27**  
**FRAME SIZE -**  
 H - 49cm W - 44cm



**1000252**  
**HOUSTON  
5/LT FLUSH  
BRONZE**  
**E27**  
**FRAME SIZE -**  
 H - 59cm W - 58cm

**Houston  
Chrome  
Range**

1000253

**HOUSTON  
5/LT PND  
CHROME**

**E27**

FRAME SIZE -  
H - 59cm W - 58cm



1000249

**HOUSTON  
3/LT PND  
CHROME**

**E27**

FRAME SIZE -  
H - 49cm W - 44cm



**- NOTE -**

**-  
Supplied  
With  
1 MT  
Chain  
&  
Canopy  
-**

1000256

**HOUSTON  
6+3 = 9/LT PND  
CHROME**

**E27**

FRAME SIZE -  
H - 76cm W - 66cm



**Houston  
Chrome  
Range**



**1000263**  
**HOUSTON**  
**1/LT W/B**  
**CHROME**  
**E27**  
**FRAME SIZE**  
 H - 23cm  
 W - 18cm  
 P - 24cm



**1000257**  
**HOUSTON**  
**SEMI FLUSH**  
**2/LT CHROME**  
**E27**  
**FRAME SIZE -**  
 H - 39cm W - 33cm

*Features  
Opal  
Matt  
Glassware*



**1000261**  
**HOUSTON**  
**SINGLE**  
**SUSPENSION**  
**2/LT**  
**CHROME**  
**E27**  
**FRAME SIZE -**  
 H - 57cm W - 33cm

**- NOTE -**  
 -  
*Supplied  
With  
1 MT  
Chain  
&  
Canopy*  
 -



**1000247**  
**HOUSTON**  
**3/LT FLUSH**  
**CHROME**  
**E27**  
**FRAME SIZE -**  
 H - 49cm W - 44cm



**1000251**  
**HOUSTON**  
**5/LT FLUSH**  
**CHROME**  
**E27**  
**FRAME SIZE -**  
 H - 59cm W - 58cm

# Benson Bronze Range

1001169

**BENSON UP  
3/LT PND  
BRONZE**  
E27  
FRAME SIZE -  
H - 27cm W - 42cm  
RODS & KNUCKLE  
AS PER  
3LT PND



1001173  
**BENSON DOWN  
3/LT PND  
BRONZE**  
E27  
FRAME SIZE -  
H - 35cm W - 42cm



*Benson  
1/LT W/B  
Can Be  
Installed  
Either  
Facing Up  
Or  
Facing Down*



1001167

**BENSON  
DOWN  
1/LT W/B  
BRONZE**  
E27  
FRAME SIZE  
H - 26cm  
W - 15cm  
P - 22cm



*\*Features\*  
Classic  
Hampton  
&  
Provincial  
Style*

1001171

**BENSON UP  
5/LT PND  
BRONZE**  
E27  
FRAME SIZE -  
H - 30cm W - 60cm



1001175

**BENSON DOWN  
5/LT PND  
BRONZE**  
E27  
FRAME SIZE -  
H - 36cm W - 60cm







*Benson  
1/LT W/B  
Can Be  
Installed  
Either  
Facing Up  
Or  
Facing Down*

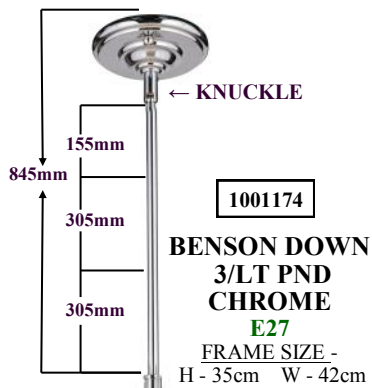

## *Benson Chrome Range*



**1001168**

**BENSON UP  
1/LT W/B  
CHROME**  
E27  
FRAME SIZE  
H - 26cm  
W - 15cm  
P - 22cm



**1001170**

**BENSON UP  
3/LT PND  
CHROME**  
E27  
FRAME SIZE -  
H - 27cm W - 42cm  
RODS & KNUCKLE  
AS PER  
3LT PND

*\*Features\*  
Classic  
Hampton  
&  
Provincial  
Style*



**1001172**

**BENSON UP  
5/LT PND  
CHROME**  
E27  
FRAME SIZE -  
H - 30cm W - 60cm



**1001176**

**BENSON DOWN  
5/LT PND  
CHROME**  
E27  
E-27 L/H  
FRAME SIZE -  
H - 36cm W - 60cm

**Rivoli  
Bronze  
Range**



**1001418**  
**RIVOLI**  
**1/LT W/B**  
**BRONZE**  
**E27**  
**FRAME SIZE**  
 H - 23cm  
 W - 15cm  
 P - 22cm

**1001424**  
**RIVOLI**  
**SEMI FLUSH**  
**3/LT**  
**BRONZE**  
**E27**  
**FRAME SIZE**  
 H - 42cm W - 42cm



**- NOTE -**  
 -  
Supplied  
With  
1MT  
Chain  
&  
Canopy  
 -

**\*Features\***  
**Classic**  
**Hampton**  
**&**  
**Provincial**  
**Style**

**1001422**  
**RIVOLI**  
**5/LT PND**  
**BRONZE**  
**E27**  
**FRAME SIZE**  
 H - 47cm W - 57cm



**1001426**  
**RIVOLI**  
**SINGLE SUSPENSION**  
**3/LT**  
**BRONZE**  
**E27**  
**FRAME SIZE**  
 H - 52cm W - 42cm

**1001420**  
**RIVOLI**  
**3/LT PND**  
**BRONZE**  
**E27**  
**FRAME SIZE**  
 H - 47cm W - 57cm



# Rivoli Satin Nickel Range

1001425

**RIVOLI  
SEMI FLUSH  
3/LT  
SATIN NICKEL**  
E27  
FRAME SIZE  
H - 42cm W - 42cm



1001419

**RIVOLI  
1/LT W/B  
SATIN  
NICKEL**  
E27  
FRAME SIZE  
H - 23cm  
W - 15cm  
P - 22cm



**- NOTE -**

-  
Supplied  
With  
1MT  
Chain  
&  
Canopy  
-

**\*Features\***  
**Classic**  
**Hampton**  
**&**  
**Provincial**  
**Style**

1001421

**RIVOLI  
3/LT PND  
SATIN NICKEL**  
E27  
FRAME SIZE  
H - 47cm W - 57cm



1001423

**RIVOLI  
5/LT PND  
SATIN NICKEL**  
E27  
FRAME SIZE  
H - 47cm W - 57cm



1001427

**RIVOLI  
SINGLE SUSPENSION  
3/LT  
SATIN NICKEL**  
E27  
FRAME SIZE  
H - 52cm W - 42cm



**Salzburg  
Bronze  
Range**



Canopy  
Supplied



1000800

**SALZBURG  
2/LT W/B BRONZE**

**E14**  
FRAME SIZE  
H - 48cm W - 30cm  
P - 18cm

**\*Features\***  
**Classic  
French  
Provincial  
Style**



1000806

**SALZBURG  
24/LT PND  
BRONZE**

**E14**  
FRAME SIZE  
H - 126cm  
W - 103cm

*Globes  
Not  
Supplied*

**Quality  
Glass  
Crystal**

**Bronze  
Finish**



1000803

**SALZBURG**  
**5/LT PND**  
**BRONZE**  
**E14**  
FRAME SIZE  
H - 55cm  
W - 55cm

*NOTE -*  
*Flush Plate Conversion Kit*  
*Available*  
*For*  
*3/LT-5/LT*

# Salzburg Bronze Range



Canopy  
Supplied



1000804

**SALZBURG**  
**8/LT PND BRONZE E14**  
FRAME SIZE - H - 73cm W - 72cm

*- NOTE -*  
*-*  
*Supplied*  
*With*  
*1 MT*  
*Chain*  
*&*  
*Canopy*  
*-*

*Quality*  
*Glass*  
*Crystal*



1000805

**SALZBURG**  
**12/LT PND**  
**BRONZE**  
**E14**  
FRAME SIZE  
H - 106cm  
W - 83cm

*Globes*  
*Not*  
*Supplied*



1000801

**SALZBURG**  
**3/LT PND BRONZE E14**  
FRAME SIZE - H - 45cm W - 50cm

# Louis 15th Bronze Range

1000295

LOUIS 15th  
3/LT PEND  
BRONZE  
E14  
FRAME SIZE  
H - 70cm  
W - 45cm

- NOTE -  
-  
Supplied  
With  
1 MT  
Chain  
&  
Canopy  
-



1000298

LOUIS 15th  
2/LT W/B BRONZE E14  
FRAME SIZE  
H - 43cm W - 34cm  
P - 19cm



1000292

LOUIS 15th  
24/LT = 12/LT + 6/LT + 6/LT  
PND BRONZE E14  
FRAME SIZE - H - 170cm W -

*Globes  
Not  
Supplied*

1000297

LOUIS 15th  
6/LT PEND  
BRONZE E14  
FRAME SIZE -  
H - 93cm W - 72cm



*- NOTE -*  
*-*  
*Supplied*  
*With*  
*1 MT*  
*Chain*  
*&*  
*Canopy*  
*-*

*Flush Plate*  
*Conversion Kit*  
*Available For*  
*3/LT-5/LT*

1000296

LOUIS 15th  
5/LT PEND  
BRONZE  
E14  
FRAME SIZE  
H - 74cm  
W - 63cm



*Quality*  
*Glass*  
*Crystal*

*\*Features\**  
*Classic*  
*French*  
*Provincial*  
*Style*

1000294

LOUIS 15th  
15/LT =  
10/LT + 5/LT PND  
BRONZE  
E14  
FRAME SIZE  
H - 126cm W - 102cm



*Globes*  
*Not*  
*Supplied*

**Odeon  
Bronze  
Range**

1000136

**ODEON  
MEDIUM 3/LT  
BRONZE**  
E14  
FRAME SIZE  
H - 35cm W - 40cm



Canopy  
Supplied

**- NOTE -**

*Supplied  
With  
1 MT  
Chain  
&  
Canopy*

1000137

**ODEON  
LARGE 6/LT  
BRONZE**  
E14  
FRAME SIZE  
H - 50cm W - 51cm



*Globes  
Not  
Supplied*

**Quality  
Glass  
Crystal**

**- NOTE -**

*Supplied  
With  
1 MT  
Chain  
&*

*Flat Ceiling Plate  
Size -  
L - 77cm W - 11cm  
D - 2cm*



1001135

**ODEON  
BENCH 12/LT  
BRONZE**  
E14  
FRAME SIZE  
H - 40cm W - 36cm  
L - 125cm





*Cascade  
Bronze  
Range*



Canopy  
Supplied

1000096

CASCADE  
SMALL 35cm  
BASKET 3/LT  
ARCHAIZE  
BRONZE

E14

FRAME SIZE

H - 47cm  
W - 35cm

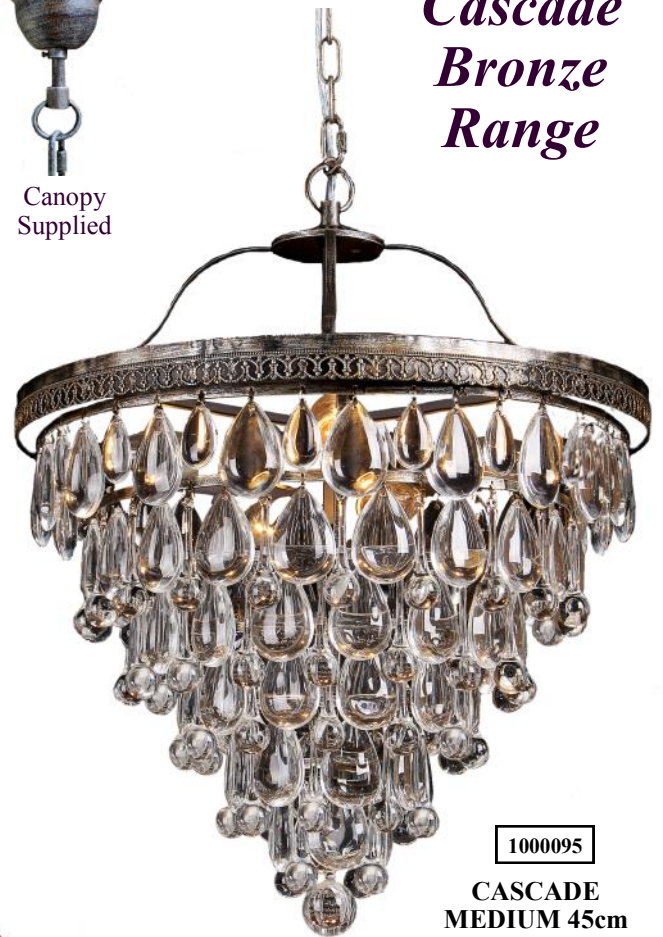

1000095

CASCADE  
MEDIUM 45cm  
BASKET 6/LT  
ARCHAIZE  
BRONZE

E14

FRAME SIZE

H - 57cm  
W - 45cm

- NOTE -

-  
Supplied  
With  
1/2 MT  
Chain  
&  
Canopy  
-

*Globes  
Not  
Supplied*



1000094

CASCADE  
LARGE 55cm  
BASKET 10/LT  
ARCHAIZE  
BRONZE

E14

FRAME SIZE

H - 67cm  
W - 55cm

*High  
Quality  
Glass  
Tear  
Drops*

**Marseilles  
Basket  
Bronze  
Range**



Canopy  
Supplied

1000808

**MARSEILLES  
BASKET  
MEDIUM  
6/LT  
BRONZE  
E14  
FRAME SIZE  
H - 76cm  
W - 44cm**

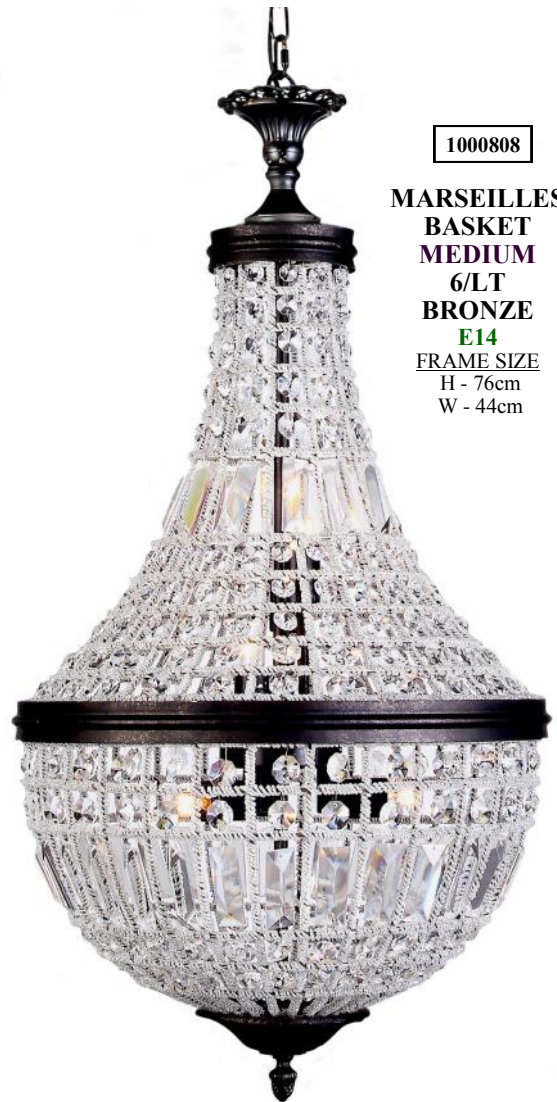

**- NOTE -**

**-  
Supplied  
With  
1 MT  
Chain  
&  
Canopy  
-**

1000807

**MARSEILLES  
BASKET  
LARGE  
8/LT  
BRONZE  
E14  
FRAME SIZE  
H - 90cm  
W - 53cm**



**Quality  
Glass  
Crystal**

1000809

**MARSEILLES  
BASKET  
SMALL  
6/LT  
BRONZE  
E14  
FRAME SIZE  
H - 65cm  
W - 34cm**



**Globes  
Not  
Supplied**

*High  
Quality  
Crystal*



Canopy  
Supplied

*Marseilles  
Ball  
Bronze  
Range*

1000810

**MARSEILLES  
BALL  
LARGE  
3/LT BRONZE**  
E14  
FRAME SIZE  
H - 58cm  
W - 45cm

*Globes  
Not  
Supplied*

*Quality  
Glass  
Crystal*

- NOTE -

-  
Supplied  
With  
1 MT  
Chain  
&  
Canopy  
-

1000811

**MARSEILLES  
BALL  
SMALL 1/LT  
BRONZE**  
E27  
FRAME SIZE  
H - 38cm  
W - 31cm



*Le Pavillon  
Antique  
Brass  
Range*



1000279

LE PAVILLON  
BASKET  
LARGE 40cm  
5/LT  
ANTIQUE  
BRASS

E14  
FRAME SIZE -  
H - 68cm W - 41cm

*Globes  
Not  
Supplied*



1000281

LE PAVILLON  
BASKET  
SMALL 30cm  
3/LT  
ANTIQUE  
BRASS

E14  
FRAME SIZE -  
H - 48cm W - 30cm

*- NOTE -  
-  
Supplied  
With  
1 MT  
Chain  
&  
Canopy  
-*

*Quality  
Glass  
Crystal*

*Le Pavillon  
Antique  
Brass  
Range*

*Quality  
Glass  
Crystal*



1000283

**LE PAVILLON  
FLUSH 40cm  
LARGE 3/LT  
ANTIQU BRASS  
E14  
FRAME SIZE -  
H - 23cm W - 40cm**



1000285

**LE PAVILLON  
FLUSH 25cm  
SMALL 3/LT  
ANTIQU BRASS  
E14  
FRAME SIZE -  
H - 20cm W - 25cm**

*Globes  
Not  
Supplied*



1000287

**LE PAVILLON  
2/LT  
WALL BRACKET  
ANTIQU BRASS  
E14  
FRAME SIZE -  
H - 41cm W - 25cm  
P - 17cm**

**Celestial  
Chrome  
Range**



1001100

**CELESTIAL  
PND 9/LT 6 TIER  
CHROME**

**E14**

FRAME SIZE  
H - 68cm W - 39cm

**- NOTE -**  
-  
**Supplied  
With  
1/2 MT  
Chain  
&  
Canopy**  
-



Canopy  
Supplied



1001101

**CELESTIAL  
W/B 2/LT 2TIER  
CHROME**

**E14**

FRAME SIZE  
H - 24cm W - 24cm  
P - 14cm

*Globes  
Not  
Supplied*

**Quality  
Glass  
Crystal**



1001096

**CELESTIAL  
FLUSH  
6/LT 5 TIER  
CHROME**

**E14**

FRAME SIZE  
H - 40cm W - 40cm



1001097

**CELESTIAL  
PND 10/LT 5 TIER  
CHROME**

**E14**

FRAME SIZE

H - 50cm W - 49cm

*Globes  
Not  
Supplied*



Canopy  
Supplied

## *Celestial Chrome Range*

*Quality  
Glass  
Crystal*

- NOTE -

-  
Supplied  
With  
1/2 MT  
Chain  
&  
Canopy  
-



1001099

**CELESTIAL  
PND 5/LT 4 TIER  
CHROME**

**E14**

FRAME SIZE

H - 43cm W - 39cm

1001098

**CELESTIAL  
PND 4/LT 3 TIER  
CHROME**

**E14**

FRAME SIZE

H - 35cm W - 29cm



# Waterfall Chrome Range

*New*

1001573

**WATERFALL  
PND 12/LT 9 TIER  
CHROME**

**E14**

FRAME SIZE

H - 98cm W - 50cm  
ATT-WEIGHT 32KG

- NOTE -

-  
Supplied  
With  
100 CM  
Chain  
+  
Canopy

*Quality  
Glass  
Crystal*



1001574

**WATERFALL  
W/B 2/LT 3 TIER  
CHROME**

**E14**

FRAME SIZE

H - 31cm W - 26cm  
P - 16cm

*Globes  
Not  
Supplied*





# Waterfall Chrome Range

*New*



1001575

**WATERFALL  
PND 3/LT 3 TIER  
CHROME**

**E14**

**FRAME SIZE  
H - 33cm W - 31cm**

- NOTE -

Supplied  
With  
86 CM  
Chain  
+  
Canopy

1001577

**WATERFALL  
PND 5/LT 4 TIER  
CHROME**

**E14**

**FRAME SIZE  
H - 37cm W - 41cm**

*Globes  
Not  
Supplied*



1001576

**WATERFALL  
FLUSH 5/LT 4 TIER  
CHROME**

**E14**

**FRAME SIZE  
H - 40cm W - 41cm**

*Quality  
Glass  
Crystal*

**Emporia  
Chrome  
Range**

**New**

**Quality  
Glass  
Crystal**

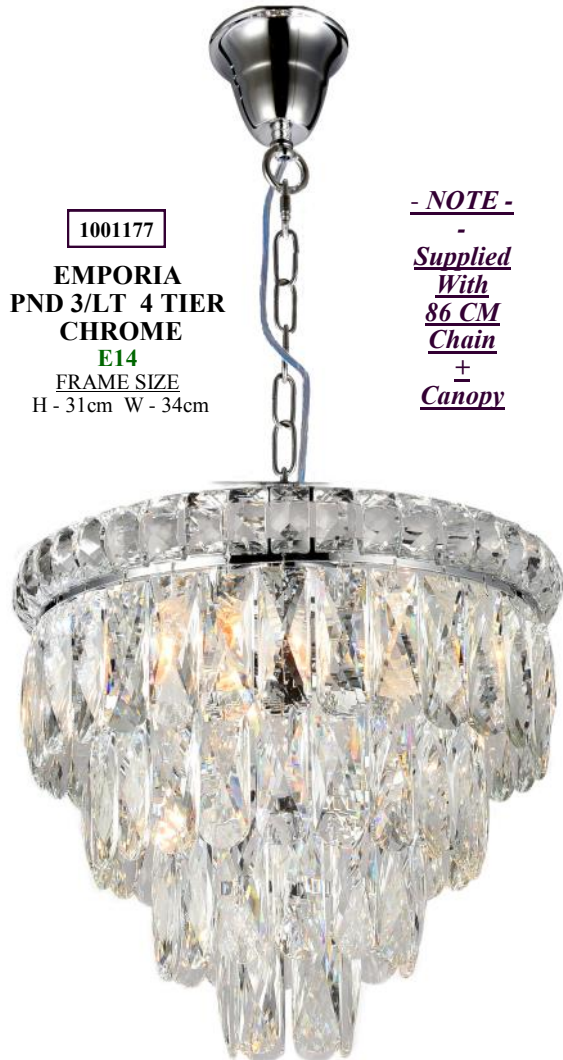

**1001177**

**EMPORIA  
PND 3/LT 4 TIER  
CHROME  
E14  
FRAME SIZE  
H - 31cm W - 34cm**

**- NOTE -  
-  
Supplied  
With  
86 CM  
Chain  
+  
Canopy**



**1001180**

**EMPORIA  
W/B 2/LT 3 TIER CHROME E14  
FRAME SIZE - H - 28cm W - 28cm P - 17cm**



**1001179**

**EMPORIA  
PND 8/LT 5 TIER  
CHROME  
E14  
FRAME SIZE  
H - 36cm W - 45cm**

**Globes  
Not  
Supplied**



**1001178**

**EMPORIA  
FLUSH 5/LT 5 TIER  
CHROME  
E14  
FRAME SIZE  
H - 39cm W - 45cm**

# Hollywood Chrome Range

*New*

1001219

**HOLLYWOOD  
PND 5/LT 2 TIER  
CHROME**

**E14**

**FRAME SIZE  
H - 44cm W - 32cm**



**- NOTE -**

**-  
Supplied  
With  
1/2 MT  
Chain  
&  
Canopy  
-**

1001218

**HOLLYWOOD  
PND 11/LT 3 TIER  
CHROME**

**E14**

**FRAME SIZE  
H - 61cm W - 46cm**



*Globes  
Not  
Supplied*

**Quality  
Glass  
Crystal**

# Rotondo Chrome Range

Globes  
Not  
Supplied

1000428

**ROTONDO  
PENDANT 6/LT  
LARGE 50cm  
CHROME**

**E14**

FRAME SIZE

H - 17cm

W - 50cm

ADD CABLE

SUSPENSION

88cm



1000429

**ROTONDO  
PENDANT 5/LT  
MEDIUM 40cm  
CHROME**

**E14**

FRAME SIZE

H - 17cm

W - 40cm

ADD CABLE

SUSPENSION

88cm



*Quality  
Glass  
Crystal*

*Rotondo  
Chrome  
Range*



1000427

**ROTONDO  
FLUSH 3/LT  
SMALL 30cm  
CHROME**

**E14**

**FRAME SIZE**  
H - 18cm W - 30cm

*High  
Quality  
Crystal*

1000426

**ROTONDO  
FLUSH 5/LT  
MEDIUM 40cm  
CHROME**

**E14**

**FRAME SIZE**  
H - 18cm W - 40cm

*Quality  
Glass  
Crystal*

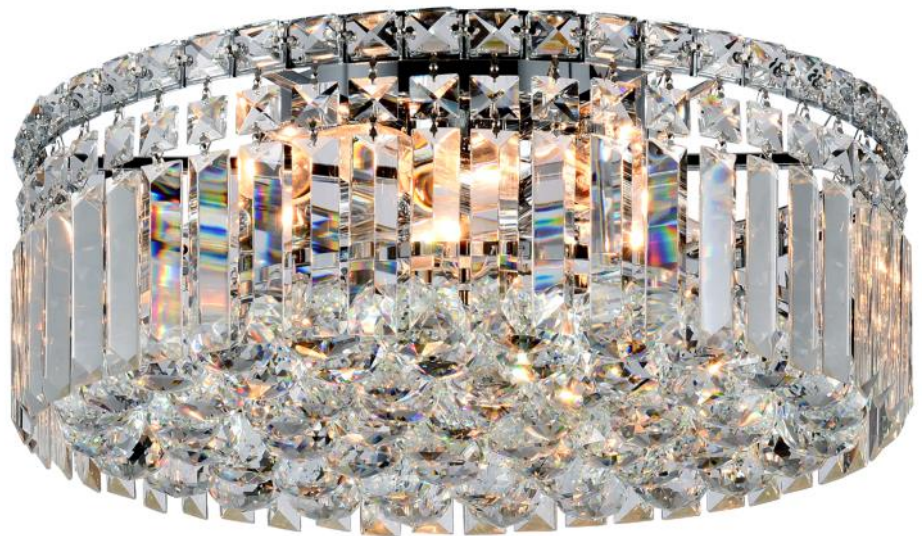

*Globes  
Not  
Supplied*



1000425

**ROTONDO  
FLUSH 6/LT  
LARGE 50cm  
CHROME**

**E14**

**FRAME SIZE -**  
H - 18cm W - 50cm

*Classique  
Chrome  
Range*

*- NOTE -  
-  
Supplied  
With  
LMT  
Chain  
&  
Canopy  
-*

1000113

**CLASSIQUE  
BASKET  
27/LT 100cm  
CHROME**

**E14**

FRAME SIZE

H - 145cm W - 100cm



*Globes  
Not  
Supplied*

*Quality  
Glass  
Crystal*



1000114

**CLASSIQUE  
FLUSH 6/LT  
LARGE 50cm CHROME E14**  
FRAME SIZE - H - 34cm W - 50cm



1000115

**CLASSIQUE  
FLUSH 5/LT  
MEDIUM 40cm CHROME E14**  
FRAME SIZE - H - 30cm W - 40cm



1000116

**CLASSIQUE  
FLUSH 3/LT  
SMALL 30cm CHROME E14**  
FRAME SIZE - H - 28cm W - 30cm

*Classique  
Chrome  
Range*



1000112

**CLASSIQUE  
BASKET  
5/LT 40cm  
CHROME**

**E14**

**FRAME SIZE  
H - 68cm W - 40cm**



Canopy  
Supplied

*Globes  
Not  
Supplied*



1001117

**CLASSIQUE  
BASKET  
18/LT 75cm  
CHROME**

**E14**

**FRAME SIZE  
H - 120cm W - 75cm**

**- NOTE -**

**-  
Supplied  
With  
1/2 MT  
Chain  
&  
Canopy  
-**



1000111

**CLASSIQUE  
BASKET  
6/LT 50cm  
CHROME**

**E14**

**FRAME SIZE  
H - 71cm W - 50cm**

*Quality  
Glass  
Crystal*

# Zurich Chrome Range

- NOTE -  
-  
Supplied  
With  
1/2 MT  
Chain  
&  
Canopy  
-

**\* Attention \***

**RE - Metal arm chandeliers -**  
The arms are malleable and may move in transit, please open box & inspect arms before giving to your customer.  
Report any breakage immediately for replacement of arms or fitting.  
No claim for electrical work will be recognized if inspection is not made.



1000617

**ZURICH 8/LT  
CHANDELIER**  
E14  
FRAME SIZE  
H - 65cm W - 72cm

Globes  
Not  
Supplied



Canopy  
Supplied

1000609

**ZURICH 18/LT  
(12/LT + 6/LT)  
CHANDELIER**  
E14  
FRAME SIZE  
H - 82cm W - 91cm

**\*Features\***  
Classic  
Marie Therese  
Style  
Quality Glass  
Crystal Drops





Canopy  
Supplied

## Zurich Chrome Range

1000606

ZURICH 3/LT  
CHANDELIER

E14

FRAME SIZE  
H - 50cm W - 43cm

*\*Features\**  
*Classic*  
*Marie Therese Style*  
*Quality Glass*  
*Crystal Drops*



1000607

ZURICH 5/LT  
CHANDELIER

E14

FRAME SIZE  
H - 52cm W - 45cm

*Globes*  
*Not*  
*Supplied*

- NOTE -

-

Supplied  
With  
1/2 MT  
Chain  
&  
Canopy

-



1000608

ZURICH 9/LT  
(6/LT + 3/LT)  
CHANDELIER

E14

FRAME SIZE  
H - 65cm W - 55cm



1000610

ZURICH 2/LT  
WALL BRACKET

E14

FRAME SIZE  
H - 27cm W - 38cm  
P - 20cm

# Venice Chrome Range

Globes  
Not  
Supplied

- NOTE -  
-  
Supplied  
With  
1MT  
Chain  
&  
Canopy  
-

**\* Attention \***  
**RE - Crystal arm chandeliers -**  
**Due to the possible breakage of**  
**arms in transit, please open box**  
**& inspect arms before giving**  
**to your customer.**  
**Report any breakage**  
**immediately for replacement**  
**of arms or fitting.**  
**No claim for electrical work**  
**will be recognized if**  
**inspection is not made.**



1000533

VENICE 9/LT  
(6/LT + 3/LT)  
CHANDELIER

E14

FRAME SIZE

H - 65cm W - 66cm

**\*Features\***  
**Quality Glass**  
**Crystal Drops**  
**With**  
**Glass Arms**

1000530

VENICE 3/LT  
CHANDELIER  
E14  
FRAME SIZE  
H - 49cm W - 46cm



*Globes  
Not  
Supplied*

1000531

VENICE 5/LT  
CHANDELIER  
E14  
FRAME SIZE  
H - 49cm W - 46cm



*Venice  
Chrome  
Range*

*- NOTE -  
-  
Supplied  
With  
1 MT  
Chain  
&  
Canopy  
-*

*\* Attention\**

*RE - Crystal arm chandeliers -  
Due to the possible breakage of  
arms in transit, please open box  
& inspect arms before giving  
to your customer.  
Report any breakage  
immediately for replacement  
of arms or fitting.  
No claim for electrical work  
will be recognized if  
inspection is not made.*

1000532

VENICE 8/LT  
CHANDELIER  
E14  
FRAME SIZE  
H - 49cm W - 55cm



1000535

VENICE 1/LT  
WALL BRACKET  
E14  
FRAME SIZE  
H - 23cm W - 12cm  
P - 23cm



**Berlin  
Chrome  
Range**



1000063

**BERLIN 3/LT PND**  
E14  
FRAME SIZE -  
H - 57cm W - 51cm



1000066

**BERLIN**  
**2/LT W/B E14**  
FRAME SIZE -  
H - 31cm W - 40cm  
P - 19cm

1000064

**BERLIN**  
**5/LT PND**  
E14  
FRAME SIZE -  
H - 60cm  
W - 57cm

**- NOTE -**  
-  
**Supplied**  
**With**  
**1 MT**  
**Chain**  
**&**  
**Canopy**  
-



**\*Features\***  
**Quality Glass Crystal Drops**  
**With Glass Arms**



1000065

**BERLIN**  
**8/LT PND**  
E14  
FRAME SIZE -  
H - 65cm W - 70cm

**Globes**  
**Not**  
**Supplied**

**\*Attention\***  
**RE - Crystal arm chandeliers -**  
**Due to the possible breakage of arms in transit,**  
**please open box & inspect arms before giving**  
**to your customer. Report any breakage immediately**  
**for replacement of arms or fitting. No claim for**  
**electrical work will be recognized if inspection is not made.**

- NOTE -  
-  
Supplied  
With  
1/2 MT  
Chain  
&  
Canopy  
-



1000110

**CHOPIN**  
**1/LT**  
**BASKET**  
**CROME**  
**E27**  
FRAME  
SIZE  
H - 44cm  
W - 24cm

*Quality  
Glass  
Crystal*

*Globes  
Not  
Supplied*



Canopy  
Supplied

- NOTE -  
-  
Supplied  
With  
1/2 MT  
Chain  
&  
Canopy  
-

































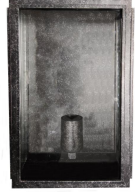





1000341

**MOZART**  
**1/LT**  
**BASKET**  
**CHROME**  
**E27**  
FRAME SIZE  
H - 54cm  
W - 28cm

*Chopin  
&  
Mozart  
Chrome  
Range*

# - Exterior Range Quick Reference Index -

	<b>NAVIGATOR</b> BRASS E27 - IP - 56 P - 70		<b>WELLINGTON</b> ANTIQUEBLACK E27 - IP - 44 1- LARGE 2- MEDIUM 3- SMALL P - 79 / 80		<b>STATION</b> ANTIQUE BLACK E27 - IP - 03 P - 92		<b>PARKWAY</b> ANTIQUE BRONZE E27 - IP - 44 P - 99
	<b>ADMIRAL</b> BRASS E27 - IP - 56 P - 70		<b>ALBANY</b> ANTIQUE BRONZE E27 - IP - 44 1- MEDIUM 2- SMALL 3- MINI P - 81 / 82		<b>URBAN</b> ANTIQUE BRONZE E27 - IP - 03 P - 93		<b>CAUSEWAY</b> ANTIQUE BRONZE E27 - IP - 44 P - 100
	<b>MARINA</b> BRASS E27 - IP - 56 P - 70		<b>STRAND</b> ANTIQUE BRONZE E27 - IP - 44 1- MEDIUM 2- SMALL P - 83 / 84		<b>TERMINAL</b> ANTIQUE BRONZE E27 - IP - 03 P - 94		<b>RIVERSIDE</b> ANTIQUE BLACK E27 - IP - 03 P - 101
	<b>MARITIME</b> BRASS E27 - IP - 56 P - 70		<b>TILBURN</b> ANTIQUE BRONZE E27 - IP - 44 1- LARGE 2- MEDIUM P - 85 / 86		<b>PORT</b> ANTIQUE BRONZE E27 - IP - 44 P - 95		<b>RIVERSIDE</b> ANTIQUE BRONZE E27 - IP - 03 P - 101
	<b>HARBOUR</b> BRASS E27 - IP - 56 P - 70		<b>JUNCTION</b> ANTIQUE BRONZE E27 - IP - 44 1- MEDIUM 2- SMALL P - 71 / 72		<b>DOCKYARD</b> ANTIQUE BRONZE E27 - IP - 55 P - 96		<b>SOUTHBY</b> ANTIQUE BRONZE E27 - IP - 44 P - 102
	<b>REGATTA</b> BRASS E27 - IP - 56 P - 70		<b>MAYFAIR</b> ANTIQUE BRONZE E27 - IP - 44 P - 87 / 88		<b>DECKHOUSE</b> ANTIQUE BRONZE E27 - IP - 55 P - 97		<b>FRONTAGE</b> ANTIQUE BLACK E27 - IP - 44 1- LARGE 2- MEDIUM 3- SMALL P - 103
	<b>FLINDERS</b> ANTIQUE BRONZE E27 - IP - 12 1- LARGE 2- MEDIUM 3- SMALL P - 73 / 74		<b>TRANSIT</b> ANTIQUE BRONZE E27 - IP - 22 P - 89		<b>PIER</b> ANTIQUE BRONZE E27 - IP - 55 P - 98		<b>MONTROSE</b> ANTIQUE BRONZE E27 - IP - 44 1- LARGE 2- SMALL P - 104
	<b>FLINDERS</b> ANTIQUE BLACK E27 - IP - 12 1- LARGE 2- MEDIUM 3- SMALL P - 75 / 76		<b>PROMENADE</b> ANTIQUE BRONZE E27 - IP - 03 1- MEDIUM 2- SMALL P - 90		<b>WHARF</b> ANTIQUE BRONZE E27 - IP - 55 P - 98		<b>LOFT</b> ANTIQUE BRONZE E27 - IP - 44 P - 104
	<b>WATERFORD</b> ANTIQUE BLACK E27 - IP - 44 1- LARGE 2- MEDIUM 3- SMALL P - 77 / 78		<b>ARGYLE</b> ANTIQUE BLACK E27 - IP - 03 P - 91		<b>GATEWAY</b> ANTIQUE BRONZE E27 - IP - 44 P - 98		<b>WICKHAM</b> ANTIQUE BLACK E27 - IP - 44 P - 105
							<b>WICKHAM</b> ANTIQUE BRONZE E27 - IP - 44 P - 105

## - Warranty Conditions -

Any claim must be made within 12 Months from the date of purchase.  
To make a claim, take the product with a Receipt of proof of purchase to retailer.

## - Warranty Exclusions -

1 - Fading due to weather exposure. 2 - Installation within 2km of salt water spray.  
3 - Damage to product through accident, misuse or negligence.

# Solid Brass Exterior Range

New

- \* Attention \***
- These products are designed to age in a patina finish.
  - The integrity of the product will not alter.
  - Solid high grade cast brass material used.
  - Robust yet hand crafted ensuring long life.
  - Can withstand ocean side locations but will age/patina with time.
  - Hand polishing required to keep brass look.
  - These products are not lacquered purposely to age/patina finish.
- \* Suggested additional care for the Purchaser to undertake\***  
Lacquer spray unit without glass to maintain finish for longer period if patina finish not preferred.



1001202

**HARBOUR SOLID BRASS**  
E27 - 60W/LED 10W - WEIGHT 1.2KG  
FRAME SIZE  
H - 260mm W - 109mm P - 130mm



1001206

**REGATTA SOLID BRASS**  
E27 - 60W/LED 10W / WEIGHT 1KG  
FRAME SIZE  
H - 209mm W - 109mm

Globes  
Not  
Supplied



1001205

**NAVIGATOR SOLID BRASS**  
E27 - 60W/LED 10W - WEIGHT 1KG  
FRAME SIZE  
H - 109mm W - 209mm P - 120mm



1001201

**ADMIRAL SOLID BRASS**  
E27 - 60W/LED 10W - WEIGHT 1KG  
FRAME SIZE  
H - 109mm W - 209mm P - 120mm

QUALITY  
SOLID  
CAST  
BRASS



1001203

**MARINA SOLID BRASS**  
E27 - 60W/LED 10W - WEIGHT 1KG  
FRAME SIZE - H - 180mm W - 180mm P - 87mm



1001204

**MARITIME SOLID BRASS**  
E27 - 60W/LED 10W - WEIGHT 1KG  
FRAME SIZE - H - 180mm W - 180mm P - 87mm

IP - 56  
Rated

**- Warranty Conditions -**  
Any claim must be made within 12 Months from the date of purchase.  
To make a claim, take the product with a Receipt of proof of purchase to retailer.

70

**- Warranty Exclusions -**  
1 - Fading due to weather exposure. 2 - Installation within 2km of salt water spray.  
3 - Damage to product through accident, misuse or negligence.

# Junction Exterior Range

**Antique  
Black**



**1001235**

**JUNCTION  
MEDIUM  
SINGLE  
POST  
ON A  
STANDARD  
3 PIECE  
POST**

**E27**

**FRAME SIZE**

H - 233cm  
W - 29cm

**\* NOTE \***  
*Single  
Post  
Is  
Supplied  
With  
A  
Total  
3  
Pieces  
+  
Post Top  
-*



**- NOTE -  
Chain  
Pendant  
Is For  
Interior  
Use  
Only**

**-  
Supplied  
With A  
1 MT  
Chain**

**1001236**

**JUNCTION  
MEDIUM  
CHAIN PND**

**E27**

**FRAME SIZE -**

H - 48cm  
W - 29cm

*Globes  
Not  
Supplied*

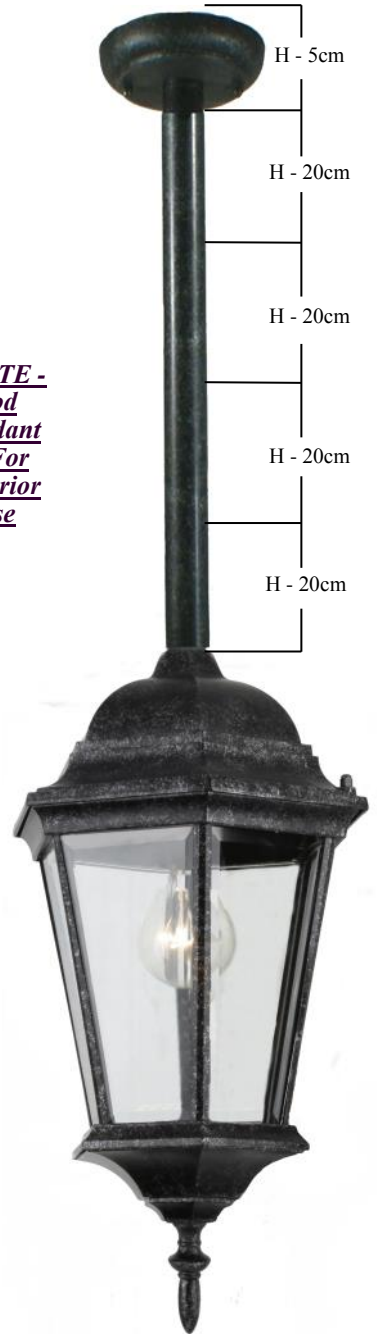

**- NOTE -  
Rod  
Pendant  
Is For  
Exterior  
Use**

H - 5cm

H - 20cm

H - 20cm

H - 20cm

H - 20cm

**1001237**

**JUNCTION  
MEDIUM  
ROD PND**

**E27**

**FRAME SIZE**

H - 48cm

W - 29cm

+ 4 x 20cm RODS

+ 1 x 5cm CAP

**IP - 44  
Rated**

**- Warranty Conditions -**

Any claim must be made within 12 Months from the date of purchase.  
To make a claim, take the product with a Receipt of proof of purchase to retailer.

**- Warranty Exclusions -**

1 - Fading due to weather exposure. 2 - Installation within 2km of salt water spray.  
3 - Damage to product through accident, misuse or negligence.



Globes  
Not  
Supplied

*Antique  
Black*



*IP - 44  
Rated*



**1001243**  
**JUNCTION  
MEDIUM W/B**  
E27  
FRAME SIZE  
H - 60cm W - 29cm  
P - 25cm

**1001244**  
**JUNCTION  
SMALL W/B**  
E27  
FRAME SIZE  
H - 50cm W - 20cm  
P - 24cm



**1001242**  
**JUNCTION  
SMALL  
UNDER EAVE**  
E27  
FRAME SIZE -  
H - 40cm W - 20cm



**1001241**  
**JUNCTION  
MEDIUM  
UNDER EAVE**  
E27  
FRAME SIZE -  
H - 48cm W - 29cm



**1001238**  
**JUNCTION  
MEDIUM  
PILLAR MOUNT**  
E27  
FRAME SIZE -  
H - 69cm W - 29cm



**1001239**  
**JUNCTION  
SMALL  
PILLAR MOUNT**  
E27  
FRAME SIZE -  
H - 59cm W - 20cm

*- Warranty Conditions -*

Any claim must be made within 12 Months from the date of purchase.  
To make a claim, take the product with a Receipt of proof of purchase to retailer.

*- Warranty Exclusions -*

1 - Fading due to weather exposure. 2 - Installation within 2km of salt water spray.  
3 - Damage to product through accident, misuse or negligence.

# Flinders Antique Bronze Exterior Range



**1000196**  
**FLINDERS  
 LARGE  
 SINGLE  
 POST  
 ON A  
 STANDARD  
 3 PIECE  
 POST  
 E27**  
**FRAME SIZE**  
 H - 242cm  
 W - 30cm

**\* NOTE \***  
 Single  
 Post  
 Is  
 Supplied  
 With  
 A  
 Total  
 3  
 Pieces  
 +  
 Post Top  
 -



**1000188**  
**FLINDERS  
 LARGE  
 CHAIN PND  
 E27**  
**FRAME SIZE -**  
 H - 65cm W - 30cm

**- NOTE -**  
Chain  
Is For  
Interior  
Use  
Only  
 -  
Supplied  
With A  
1MT  
Chain

## Antique Bronze



**1000190**  
**FLINDERS  
 LARGE  
 ROD PND  
 E27**  
**FRAME SIZE**  
 H - 68cm W - 30cm  
 + 4 x 20cm RODS  
 + 1 x 5cm CAP

**- NOTE -**  
Rod  
Pendant  
Is For  
Exterior  
Use

**1000153**  
**FLINDERS  
 LARGE  
 ON  
 DOMAIN  
 POST  
 E27**  
**FRAME SIZE**  
 H - 278cm  
 W - 30cm

**\* NOTE \***  
If A  
Higher  
Post  
Height  
Is  
Required  
Please  
Use  
This  
Domain  
Post.  
Heavy  
Duty Thick  
Casting  
With  
4 Hole  
Floor  
Mounting

**IP - 12  
 Rated**

**- Warranty Conditions -**

Any claim must be made within 12 Months from the date of purchase.  
 To make a claim, take the product with a Receipt of proof of purchase to retailer.

**- Warranty Exclusions -**

1 - Fading due to weather exposure. 2 - Installation within 2km of salt water spray.  
 3 - Damage to product through accident, misuse or negligence.



1000204

**FLINDERS  
LARGE W/B**

**E27**  
FRAME SIZE  
H - 78cm W - 30cm  
P - 41cm



1000206

**FLINDERS  
MEDIUM W/B**

**E27**  
FRAME SIZE  
H - 58cm W - 20cm  
P - 30cm



1000212

**FLINDERS  
SMALL W/B**

**E27**  
FRAME SIZE  
H - 52cm W - 16cm  
P - 26cm

*IP - 12  
Rated*

*Antique  
Bronze*



1000200

**FLINDERS  
SMALL  
UNDER EAVE**

**E27**  
FRAME SIZE -  
H - 44cm W - 16cm



1000198

**FLINDERS  
MEDIUM  
UNDER EAVE**

**E27**  
FRAME SIZE -  
H - 50cm W - 20cm



1000192

**FLINDERS  
LARGE  
PILLAR MOUNT**

**E27**  
FRAME SIZE -  
H - 79cm W - 30cm



1000194

**FLINDERS  
MEDIUM  
PILLAR MOUNT**

**E27**  
FRAME SIZE -  
H - 64cm W - 20cm

*- Warranty Conditions -*  
Any claim must be made within 12 Months from the date of purchase.  
To make a claim, take the product with a Receipt of proof of purchase to retailer.

*- Warranty Exclusions -*  
1 - Fading due to weather exposure. 2 - Installation within 2km of salt water spray.  
3 - Damage to product through accident, misuse or negligence.

# Flinders Antique Black Exterior Range

## Antique Black



1000195

**FLINDERS  
LARGE  
SINGLE  
POST  
ON A  
STANDARD  
3 PIECE  
POST  
E27**  
FRAME SIZE  
H - 242cm  
W - 30cm

**\* NOTE \***  
Single  
Post  
Is  
Supplied  
With  
A  
Total  
3  
Pieces  
+  
Post Top  
-



**- NOTE -**  
Chain  
Pendant  
Is For  
Interior  
Use  
Only  
-  
Supplied  
With A  
1 MT  
Chain

1000187

**FLINDERS  
LARGE  
CHAIN PND  
E27**  
FRAME SIZE -  
H - 65cm W - 30cm

**IP - 12  
Rated**

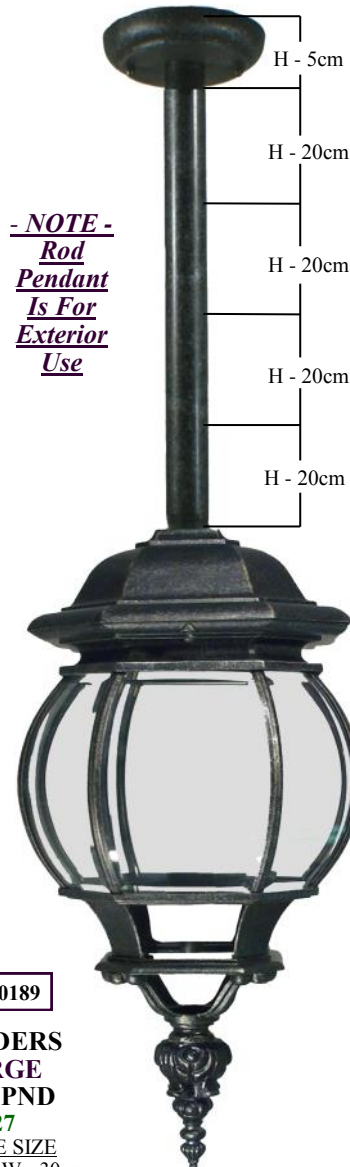

**- NOTE -**  
Rod  
Pendant  
Is For  
Exterior  
Use

1000189

**FLINDERS  
LARGE  
ROD PND  
E27**  
FRAME SIZE  
H - 68cm W - 30cm  
+ 4 x 20cm RODS  
+ 1 x 5cm CAP



1000154

**FLINDERS  
LARGE  
ON  
DOMAIN  
POST  
E27**  
FRAME SIZE  
H - 278cm  
W - 30cm

**\* NOTE \***  
If A  
Higher  
Post  
Height  
Is  
Required  
Please  
Use  
This  
Domain  
Post.  
Heavy  
Duty Thick  
Casting  
With  
4 Hole  
Floor  
Mounting

H - 5cm  
H - 20cm  
H - 20cm  
H - 20cm  
H - 20cm

**- Warranty Conditions -**

Any claim must be made within 12 Months from the date of purchase.  
To make a claim, take the product with a Receipt of proof of purchase to retailer.

**- Warranty Exclusions -**

1 - Fading due to weather exposure. 2 - Installation within 2km of salt water spray.  
3 - Damage to product through accident, misuse or negligence.



1000203

**FLINDERS  
LARGE W/B**

**E27**  
FRAME SIZE  
H - 78cm W - 30cm  
P - 41cm



1000205

**FLINDERS  
MEDIUM W/B**

**E27**  
FRAME SIZE  
H - 58cm W - 20cm  
P - 30cm



1000211

**FLINDERS  
SMALL W/B**

**E27**  
FRAME SIZE  
H - 52cm W - 16cm  
P - 26cm

*Antique  
Black*

*IP - 12  
Rated*



1000199

**FLINDERS  
SMALL  
UNDER EAVE**

**E27**  
FRAME SIZE -  
H - 44cm W - 16cm



1000197

**FLINDERS  
MEDIUM  
UNDER EAVE**

**E27**  
FRAME SIZE -  
H - 50cm W - 20cm



1000191

**FLINDERS  
LARGE  
PILLAR MOUNT**

**E27**  
FRAME SIZE -  
H - 79cm W - 30cm



1000193

**FLINDERS  
MEDIUM  
PILLAR MOUNT**

**E27**  
FRAME SIZE -  
H - 64cm W - 20cm

*- Warranty Conditions -*  
Any claim must be made within 12 Months from the date of purchase.  
To make a claim, take the product with a Receipt of proof of purchase to retailer.

*- Warranty Exclusions -*  
1 - Fading due to weather exposure. 2 - Installation within 2km of salt water spray.  
3 - Damage to product through accident, misuse or negligence.

# Waterford Exterior Range



1000565

**WATERFORD  
LARGE  
SINGLE POST  
ON A  
STANDARD  
3 PIECE POST**  
E27  
FRAME SIZE  
H - 236cm  
W - 38cm

*\* NOTE \**  
Single Post Is Supplied With A Total 3 Pieces + Post Top -



*- NOTE -*  
Chain Pendant Is For Interior Use Only - Supplied With A 1 MT Chain

1000561

**WATERFORD  
LARGE  
CHAIN PND**  
E27  
FRAME SIZE -  
H - 62cm W - 38cm

**IP - 44  
Rated**

## Antique Black

1000158

**WATERFORD  
LARGE  
ON  
DOMAIN  
POST**  
E27  
FRAME SIZE  
H - 281cm  
W - 36cm

*\* NOTE \**  
If A Higher Post Height Is Required Please Use This Domain Post. Heavy Duty Thick Casting With 4 Hole Floor Mounting

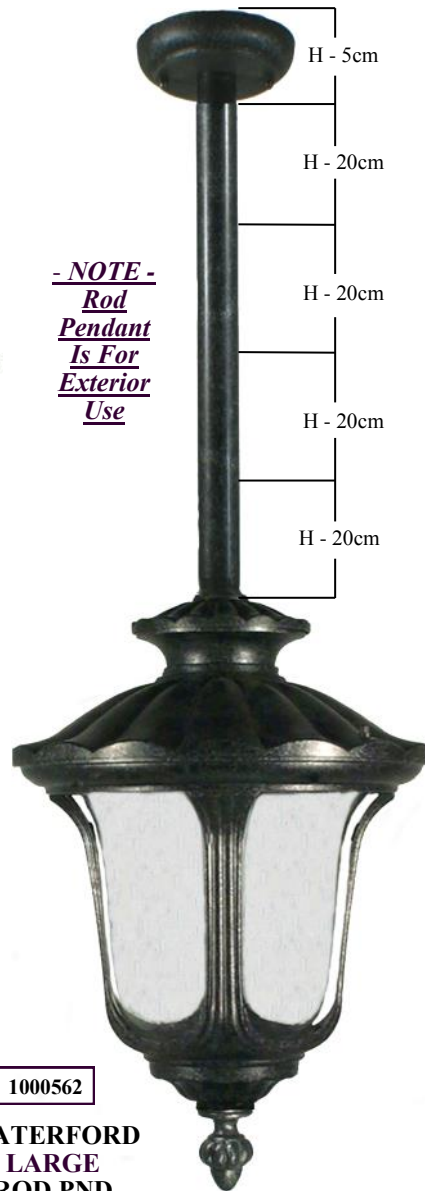

*- NOTE -*  
Rod Pendant Is For Exterior Use

H - 5cm  
H - 20cm  
H - 20cm  
H - 20cm  
H - 20cm

1000562

**WATERFORD  
LARGE  
ROD PND**  
E27  
FRAME SIZE  
H - 58cm W - 38cm  
+ 4 x 20cm RODS  
+ 1 x 5cm CAP

**- Warranty Conditions -**

Any claim must be made within 12 Months from the date of purchase. To make a claim, take the product with a Receipt of proof of purchase to retailer.

**- Warranty Exclusions -**

1 - Fading due to weather exposure. 2 - Installation within 2km of salt water spray. 3 - Damage to product through accident, misuse or negligence.



1000569

**WATERFORD  
LARGE W/B**

**E27**

FRAME SIZE

H - 70cm W - 36cm  
P - 42cm



1000571

**WATERFORD  
MEDIUM W/B**

**E27**

FRAME SIZE

H - 54cm W - 28cm  
P - 33cm



1000573

**WATERFORD  
SMALL W/B**

**E27**

FRAME SIZE

H - 45cm W - 23cm  
P - 28cm

**IP - 44  
Rated**

**Antique  
Black**



1000567

**WATERFORD  
SMALL  
UNDER EAVE**

**E27**

FRAME SIZE -

H - 41cm W - 23cm



1000566

**WATERFORD  
MEDIUM  
UNDER EAVE**

**E27**

FRAME SIZE -

H - 51cm W - 28cm



1000563

**WATERFORD  
LARGE  
PILLAR MOUNT**

**E27**

FRAME SIZE -

H - 78cm W - 36cm



1000564

**WATERFORD  
MEDIUM  
PILLAR MOUNT**

**E27**

FRAME SIZE -

H - 65cm W - 28cm

**- Warranty Conditions -**

Any claim must be made within 12 Months from the date of purchase.  
To make a claim, take the product with a Receipt of proof of purchase to retailer.

**- Warranty Exclusions -**

1 - Fading due to weather exposure. 2 - Installation within 2km of salt water spray.  
3 - Damage to product through accident, misuse or negligence.

# Wellington Exterior Range

**Antique  
Black**



1000578

**WELLINGTON  
LARGE  
SINGLE POST  
ON A  
STANDARD  
3 PIECE  
POST**

**E27**

**FRAME SIZE**

H - 226cm

W - 28cm

**\* NOTE \***

*Single  
Post  
Is  
Supplied  
With  
A  
Total  
3  
Pieces  
+  
Post Top  
-*



1000574

**WELLINGTON  
LARGE  
CHAIN PND**

**E27**

**FRAME SIZE -**

H - 52cm W - 29cm

**- NOTE -  
Chain  
Pendant  
Is For  
Interior  
Use  
Only**

**-  
Supplied  
With A  
1 MT  
Chain**

**- NOTE -  
Rod  
Pendant  
Is For  
Exterior  
Use**

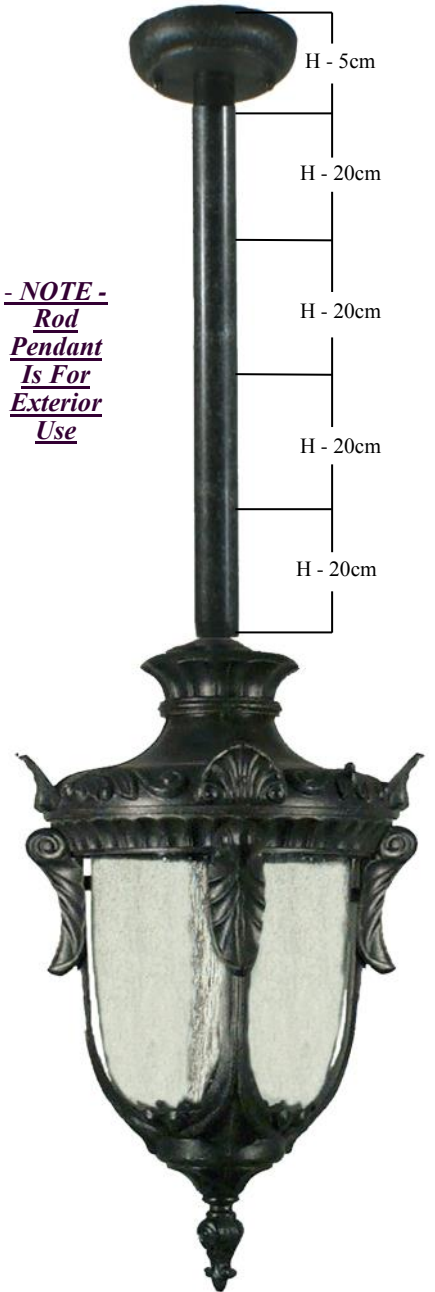

H - 5cm

H - 20cm

H - 20cm

H - 20cm

H - 20cm

1000575

**WELLINGTON  
LARGE  
ROD PND**

**E27**

**FRAME SIZE**

H - 48cm

W - 29cm

+ 4 x 20cm RODS

+ 1 x 5cm CAP

**IP - 44  
Rated**

**- Warranty Conditions -**

Any claim must be made within 12 Months from the date of purchase.  
To make a claim, take the product with a Receipt of proof of purchase to retailer.

**- Warranty Exclusions -**

1 - Fading due to weather exposure. 2 - Installation within 2km of salt water spray.  
3 - Damage to product through accident, misuse or negligence.





1000582

**WELLINGTON  
LARGE W/B**  
E27  
FRAME SIZE  
H - 64cm W - 25cm  
P - 32cm



1000584

**WELLINGTON  
MEDIUM W/B**  
E27  
FRAME SIZE  
H - 53cm W - 20cm  
P - 26cm



1000586

**WELLINGTON  
SMALL W/B**  
E27  
FRAME SIZE  
H - 43cm W - 15cm  
P - 24cm

*IP - 44  
Rated*

*Antique  
Black*



1000580

**WELLINGTON  
SMALL  
UNDER EAVE**  
E27  
FRAME SIZE -  
H - 36cm W - 15cm



1000579

**WELLINGTON  
MEDIUM  
UNDER EAVE**  
E27  
FRAME SIZE -  
H - 45cm W - 20cm



1000576

**WELLINGTON  
LARGE  
PILLAR MOUNT**  
E27  
FRAME SIZE -  
H - 68cm W - 29cm



1000577

**WELLINGTON  
MEDIUM  
PILLAR MOUNT**  
E27  
FRAME SIZE -  
H - 60cm W - 20cm

**- Warranty Conditions -**

Any claim must be made within 12 Months from the date of purchase.  
To make a claim, take the product with a Receipt of proof of purchase to retailer.

**- Warranty Exclusions -**

1 - Fading due to weather exposure. 2 - Installation within 2km of salt water spray.  
3 - Damage to product through accident, misuse or negligence.

# Albany Exterior Range



1000030

ALBANY  
MEDIUM  
SINGLE POST  
ON A  
STANDARD  
3 PIECE  
POST

E27  
FRAME SIZE  
H - 236cm  
W - 30cm

**\* NOTE \***  
Single  
Post  
Is  
Supplied  
With  
A  
Total  
3  
Pieces  
+  
Post Top  
-

**- NOTE -**  
Chain  
Pendant  
Is For  
Interior  
Use  
Only  
-  
Supplied  
With A  
1MT  
Chain



1000026

ALBANY  
MEDIUM  
CHAIN PND

E27  
FRAME SIZE -  
H - 60cm W - 30cm

**IP - 44  
Rated**

# Antique Bronze



1000155

ALBANY  
MEDIUM  
ON  
DOMAIN  
POST

E27  
FRAME SIZE  
H - 278cm W - 30cm

**\* NOTE \***  
If A  
Higher  
Post  
Height  
Is  
Required  
Please  
Use  
This  
Domain  
Post.  
Heavy  
Duty Thick  
Casting  
With  
4 Hole  
Floor  
Mounting

**- NOTE -**  
Rod  
Pendant  
Is For  
Exterior  
Use



H - 5cm

H - 20cm

H - 20cm

H - 20cm

H - 20cm

1000027

ALBANY  
MEDIUM  
ROD PND

E27  
FRAME SIZE  
H - 60cm W - 30cm  
+ 4 x 20cm RODS  
+ 1 x 5cm CAP

**- Warranty Conditions -**

Any claim must be made within 12 Months from the date of purchase.  
To make a claim, take the product with a Receipt of proof of purchase to retailer.

**- Warranty Exclusions -**

1 - Fading due to weather exposure. 2 - Installation within 2km of salt water spray.  
3 - Damage to product through accident, misuse or negligence.



1000031

**ALBANY  
MEDIUM W/B**  
E27  
FRAME SIZE  
H - 70cm W - 30cm  
P - 38cm



1000033

**ALBANY  
SMALL W/B**  
E27  
FRAME SIZE  
H - 53cm W - 22cm  
P - 28cm



1000032

**ALBANY  
MINI W/B**  
E27  
FRAME SIZE  
H - 47cm W - 17cm  
P - 22cm



1000029

**ALBANY  
SMALL PILLAR MOUNT**  
E27  
FRAME SIZE -  
H - 60cm W - 22cm

*Antique  
Bronze*

*IP - 44  
Rated*



1000028

**ALBANY  
MEDIUM PILLAR MOUNT**  
E27  
FRAME SIZE -  
H - 71cm W - 30cm

**- Warranty Conditions -**

Any claim must be made within 12 Months from the date of purchase.  
To make a claim, take the product with a Receipt of proof of purchase to retailer.

**- Warranty Exclusions -**

1 - Fading due to weather exposure. 2 - Installation within 2km of salt water spray.  
3 - Damage to product through accident, misuse or negligence.

# Strand Exterior Range

**Antique  
Bronze**



**1000494**  
STRAND  
MEDIUM  
SINGLE  
POST  
ON A  
STANDARD  
3 PIECE  
POST  
E27  
FRAME SIZE  
H - 223cm  
W - 24cm

**\* NOTE \***  
Single  
Post  
Is  
Supplied  
With  
A  
Total  
3  
Pieces  
+  
Post Top  
-



**- NOTE -**  
Chain  
Pendant  
Is For  
Interior  
Use  
Only  
-  
Supplied  
With A  
LMT  
Chain

**1000490**  
STRAND  
MEDIUM  
CHAIN PND  
E27  
FRAME SIZE -  
H - 43cm W - 24cm

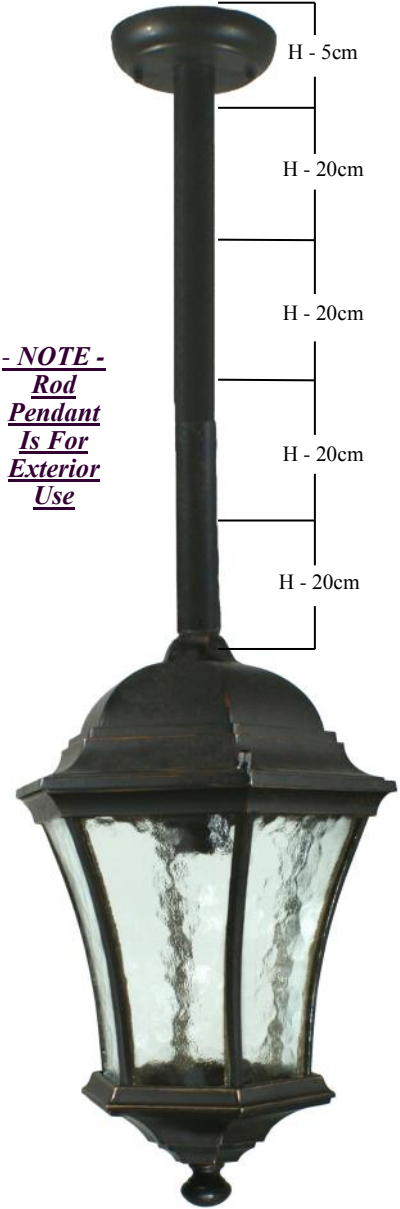

**- NOTE -**  
Rod  
Pendant  
Is For  
Exterior  
Use

**1000491**  
STRAND  
MEDIUM  
ROD PND  
E27  
FRAME SIZE  
H - 39cm  
W - 24cm  
+ 4 x 20cm RODS  
+ 1 x 5cm CAP

**IP - 44  
Rated**

**- Warranty Conditions -**

Any claim must be made within 12 Months from the date of purchase.  
To make a claim, take the product with a Receipt of proof of purchase to retailer.

**- Warranty Exclusions -**

1 - Fading due to weather exposure. 2 - Installation within 2km of salt water spray.  
3 - Damage to product through accident, misuse or negligence.



1000497

**STRAND  
MEDIUM W/B**

**E27**

**FRAME SIZE**  
H - 50cm W - 24cm  
P - 30cm



1000499

**STRAND  
SMALL W/B**

**E27**

**FRAME SIZE**  
H - 41cm W - 21cm  
P - 23cm

*Antique  
Bronze*



1000496

**STRAND  
SMALL  
UNDER EAVE**

**E27**

**FRAME SIZE -**  
H - 35cm W - 21cm



1000495

**STRAND  
MEDIUM  
UNDER EAVE**

**E27**

**FRAME SIZE -**  
H - 42cm W - 24cm



1000493

**STRAND  
SMALL  
PILLAR MOUNT**

**E27**

**FRAME SIZE -**  
H - 53cm W - 21cm



1000492

**STRAND  
MEDIUM  
PILLAR MOUNT**

**E27**

**FRAME SIZE -**  
H - 60cm W - 24cm

*IP - 44  
Rated*

**- Warranty Conditions -**

Any claim must be made within 12 Months from the date of purchase.  
To make a claim, take the product with a Receipt of proof of purchase to retailer.

**- Warranty Exclusions -**

1 - Fading due to weather exposure. 2 - Installation within 2km of salt water spray.  
3 - Damage to product through accident, misuse or negligence.

# Tilburn Exterior Range

*Antique  
Bronze*



1000819

**TILBURN  
LARGE  
SINGLE POST  
ON A  
STANDARD  
3 PIECE  
POST**

**E27**  
FRAME SIZE  
H - 223cm  
W - 23cm

*\* NOTE \**  
Single  
Post  
Is  
Supplied  
With  
A  
Total  
3  
Pieces  
+  
Post Top  
-



*- NOTE -  
Chain  
Pendant  
Is For  
Interior  
Use  
Only  
-  
Supplied  
With A  
1 MT  
Chain*

1000818

**TILBURN  
LARGE  
CHAIN PND**

**E27**  
FRAME SIZE -  
H - 47cm W - 23cm

*IP - 44  
Rated*

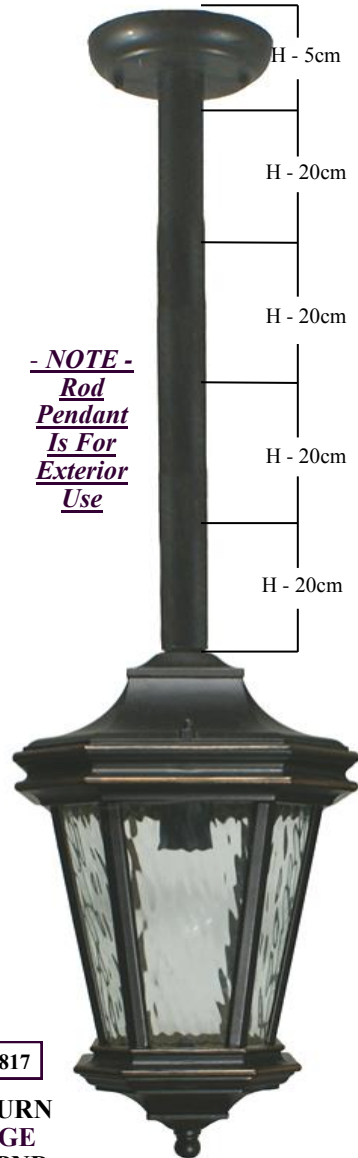

*- NOTE -  
Rod  
Pendant  
Is For  
Exterior  
Use*

1000817

**TILBURN  
LARGE  
ROD PND**

**E27**  
FRAME SIZE  
H - 43cm W - 23cm  
+ 4 x 20cm RODS  
+ 1 x 5cm CAP

1000157

**TILBURN  
LARGE  
ON  
DOMAIN  
POST**

**E27**  
FRAME SIZE  
H - 269cm W - 23cm

*\* NOTE \**  
If A  
Higher  
Post  
Height  
Is  
Required  
Please  
Use  
This  
Domain  
Post.  
Heavy  
Duty Thick  
Casting  
With  
4 Hole  
Floor  
Mounting



**- Warranty Conditions -**

Any claim must be made within 12 Months from the date of purchase.  
To make a claim, take the product with a Receipt of proof of purchase to retailer.

**- Warranty Exclusions -**

1 - Fading due to weather exposure. 2 - Installation within 2km of salt water spray.  
3 - Damage to product through accident, misuse or negligence.



1000813

**TILBURN  
LARGE W/B**  
E27  
FRAME SIZE  
H - 54cm W - 23cm  
P - 32cm



1000814

**TILBURN  
MEDIUM W/B**  
E27  
FRAME SIZE  
H - 37cm W - 17cm  
P - 23cm

*Antique  
Bronze*



1000816

**TILBURN  
LARGE  
UNDER EAVE**  
E27  
FRAME SIZE -  
H - 45cm W - 23cm

*IP - 44  
Rated*



1000815

**TILBURN  
LARGE  
PILLAR MOUNT**  
E27  
FRAME SIZE  
H - 64cm W - 23cm

**- Warranty Conditions -**

Any claim must be made within 12 Months from the date of purchase.  
To make a claim, take the product with a Receipt of proof of purchase to retailer.

**- Warranty Exclusions -**

1 - Fading due to weather exposure. 2 - Installation within 2km of salt water spray.  
3 - Damage to product through accident, misuse or negligence.

# Mayfair Exterior Range

*Antique  
Bronze*



1000315

**MAYFAIR  
SINGLE POST  
ON A  
STANDARD  
3 PIECE  
POST**

**E27**  
FRAME SIZE  
H - 228cm W - 26cm

**\* NOTE \***  
*Single  
Post  
Is  
Supplied  
With  
A  
Total  
3  
Pieces  
+  
Post Top  
-*



**- NOTE -**  
*Chain  
Pendant  
Is For  
Interior  
Use  
Only  
-  
Supplied  
With A  
1 MT  
Chain*

1000312

**MAYFAIR  
CHAIN PND**

**E27**  
FRAME SIZE -  
H - 49cm W - 26cm

**IP - 44  
Rated**

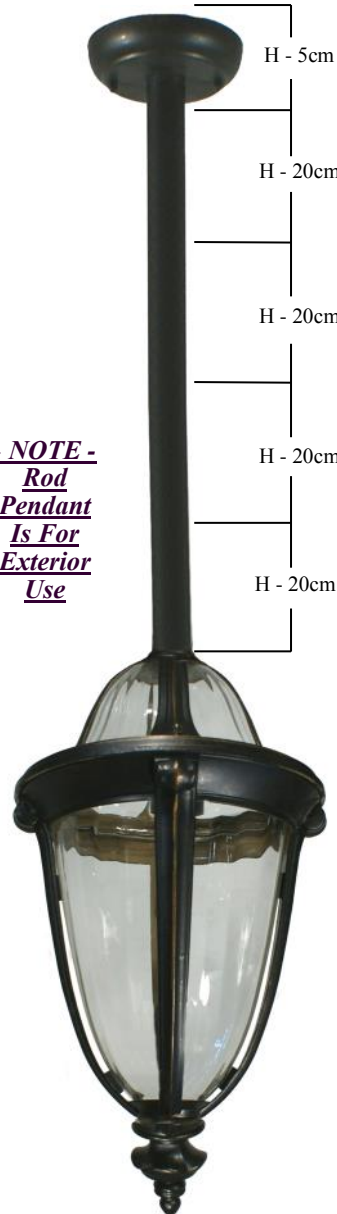

**- NOTE -**  
*Rod  
Pendant  
Is For  
Exterior  
Use*

H - 5cm

H - 20cm

H - 20cm

H - 20cm

H - 20cm

1000313

**MAYFAIR ROD PND**

**E27**  
FRAME SIZE  
H - 49cm W - 26cm  
+ 4 x 20cm RODS  
+ 1 x 5cm CAP

1000150

**MAYFAIR  
ON  
DOMAIN  
POST**

**E27**  
FRAME SIZE  
H - 269cm W - 26cm

**\* NOTE \***  
*If A  
Higher  
Post  
Height  
Is  
Required  
Please  
Use  
This  
Domain  
Post.  
Heavy  
Duty Thick  
Casting  
With  
4 Hole  
Floor  
Mounting*



**- Warranty Conditions -**

Any claim must be made within 12 Months from the date of purchase.  
To make a claim, take the product with a Receipt of proof of purchase to retailer.

**- Warranty Exclusions -**

1 - Fading due to weather exposure. 2 - Installation within 2km of salt water spray.  
3 - Damage to product through accident, misuse or negligence.



*Antique  
Bronze*



*IP - 44  
Rated*

1000317

**MAYFAIR  
W/B**

**E27**

**FRAME SIZE**

H - 57cm W - 26cm

P - 31cm



*\*Features\*  
One Piece  
Oval  
Glassware*



1000316

**MAYFAIR  
UNDER EAVE**

**E27**

**FRAME SIZE**

H - 54cm W - 26cm

1000314

**MAYFAIR  
PILLAR MOUNT**

**E27**

**FRAME SIZE**

H - 69cm W - 26cm

**- Warranty Conditions -**

Any claim must be made within 12 Months from the date of purchase.  
To make a claim, take the product with a Receipt of proof of purchase to retailer.

**- Warranty Exclusions -**

1 - Fading due to weather exposure. 2 - Installation within 2km of salt water spray.  
3 - Damage to product through accident, misuse or negligence.

**Transit  
Exterior  
Range**

**Antique  
Bronze**



**1001529**  
**TRANSIT  
MEDIUM W/B**  
E27  
FRAME SIZE  
H - 49cm W - 23cm  
P - 28cm

**Globes  
Not Supplied**

**1001530**  
**TRANSIT  
SMALL W/B**  
E27  
FRAME SIZE  
H - 39cm W - 18cm  
P - 23cm



**New  
Range**



**1001528**  
**TRANSIT  
MEDIUM  
UNDER EAVE**  
E27  
FRAME SIZE  
H - 48cm W - 23cm

**- NOTE -  
Chain  
Pendant  
Is For  
Interior  
Use  
Only -  
Supplied  
With A  
1MT  
Chain**



**1001525**  
**TRANSIT  
MEDIUM  
CHAIN PND**  
E27  
FRAME SIZE -  
H - 45cm W - 23cm

**- NOTE -  
Rod  
Pendant  
Is For  
Exterior  
Use**

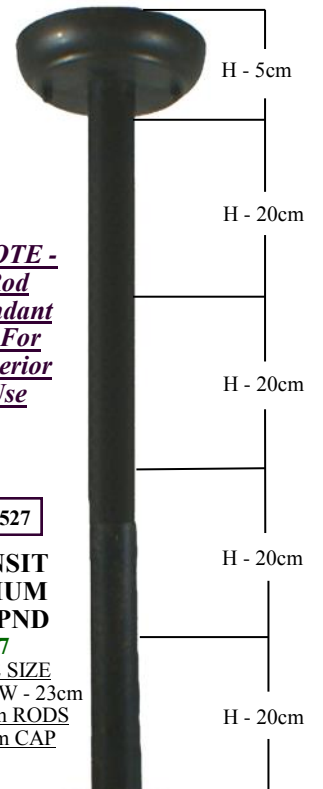

**1001527**  
**TRANSIT  
MEDIUM  
ROD PND**  
E27  
FRAME SIZE  
H - 45cm W - 23cm  
+ 4 x 20cm RODS  
+ 1 x 5cm CAP



**1001526**  
**TRANSIT  
MEDIUM  
PILLAR MOUNT**  
E27  
FRAME SIZE  
H - 68cm W - 23cm

**IP - 22  
Rated**



**- Warranty Conditions -**

Any claim must be made within 12 Months from the date of purchase.  
To make a claim, take the product with a Receipt of proof of purchase to retailer.

**- Warranty Exclusions -**

1 - Fading due to weather exposure. 2 - Installation within 2km of salt water spray.  
3 - Damage to product through accident, misuse or negligence.



**Antique  
Bronze**

1001434

**PROMENADE  
SMALL W/B**  
E27  
FRAME SIZE  
H - 30cm W - 18cm  
P - 22cm



**Promenade  
Exterior  
Range**

1001433

**PROMENADE  
MEDIUM W/B**  
E27  
FRAME SIZE  
H - 39cm W - 23cm  
P - 28cm

**New  
Range**

**- NOTE -  
Rod  
Pendant  
Is For  
Exterior  
Use**

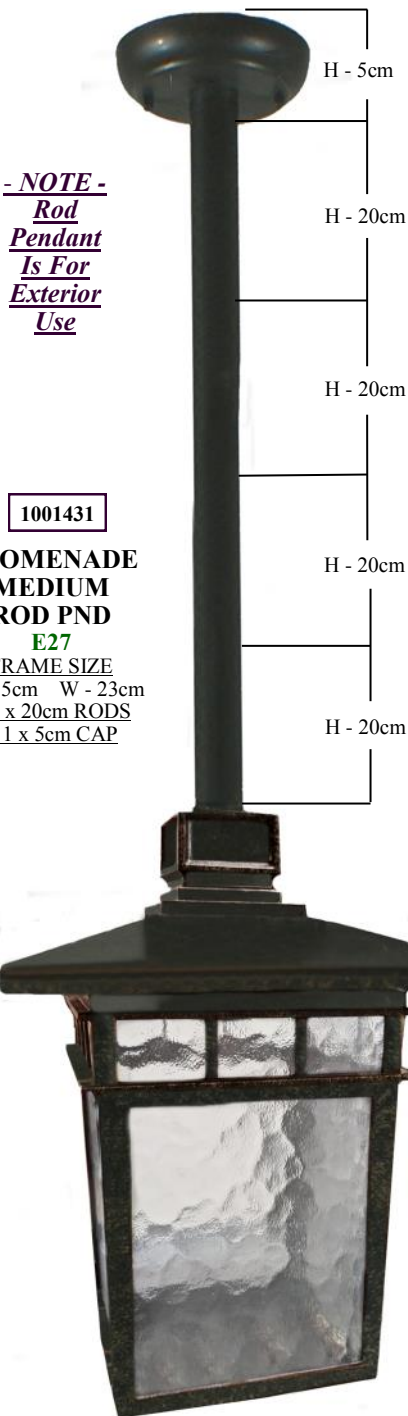

1001431

**PROMENADE  
MEDIUM  
ROD PND**  
E27  
FRAME SIZE  
H - 35cm W - 23cm  
+ 4 x 20cm RODS  
+ 1 x 5cm CAP



1001432

**PROMENADE  
MEDIUM  
UNDER EAVE**  
E27  
FRAME SIZE  
H - 39cm W - 23cm



**- NOTE -  
Chain  
Pendant  
Is For  
Interior  
Use  
Only  
-  
Supplied  
With A  
1 MT  
Chain**

1001430

**PROMENADE  
MEDIUM  
CHAIN PND**  
E27  
FRAME SIZE -  
H - 37cm W - 23cm

**IP - 03  
Rated**

**- Warranty Conditions -**

Any claim must be made within 12 Months from the date of purchase.  
To make a claim, take the product with a Receipt of proof of purchase to retailer.

90

**- Warranty Exclusions -**

1 - Fading due to weather exposure. 2 - Installation within 2km of salt water spray.  
3 - Damage to product through accident, misuse or negligence.

**Argyle  
Exterior  
Range**

**Antique  
Black**

**- NOTE -  
Rod  
Pendant  
Is For  
Exterior  
Use**



**1000044**

**ARGYLE  
W/B  
E27  
FRAME SIZE  
H - 31cm W - 17cm  
P - 22cm**

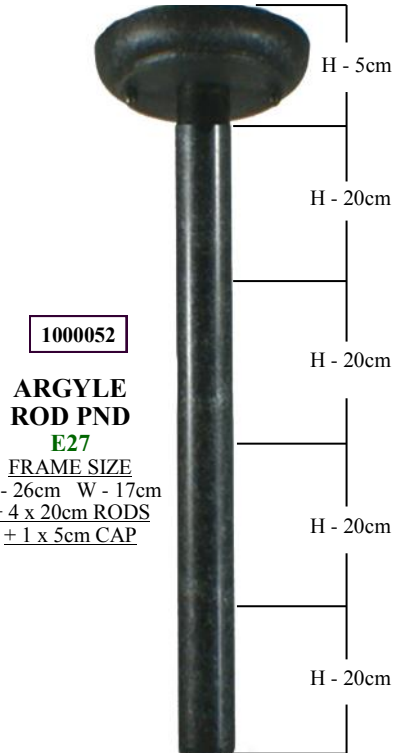

**1000052**

**ARGYLE  
ROD PND  
E27  
FRAME SIZE  
H - 26cm W - 17cm  
+ 4 x 20cm RODS  
+ 1 x 5cm CAP**

**IP - 03  
Rated**



**1000043**

**ARGYLE  
UNDER EAVE  
E27  
FRAME SIZE  
H - 30cm W - 17cm**



- NOTE -  
Rod  
Pendant  
Is For  
Exterior  
Use

*Antique  
 Black*

*Station  
 Exterior  
 Range*

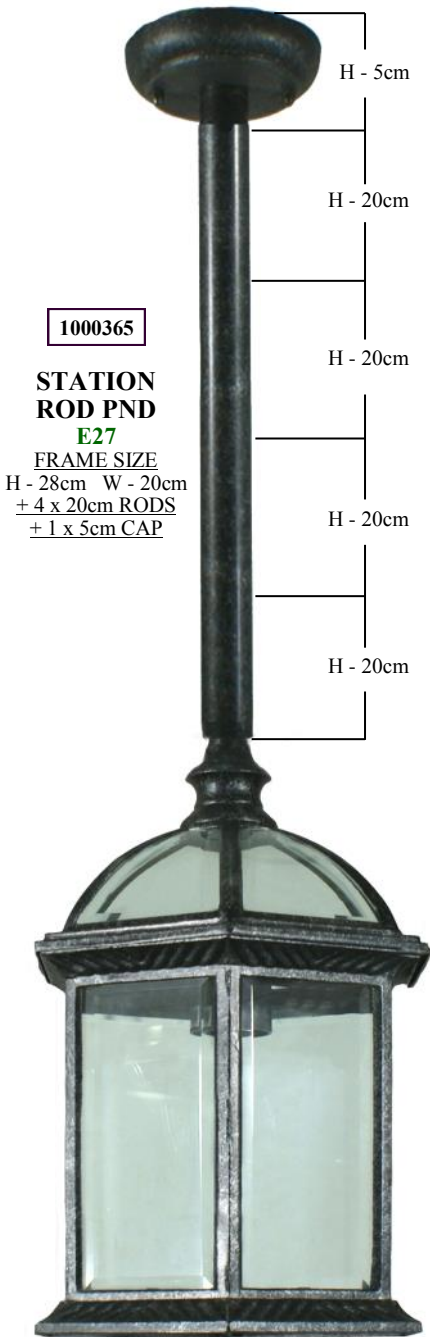

1000365

**STATION  
 ROD PND**  
**E27**  
**FRAME SIZE**  
 H - 28cm W - 20cm  
 + 4 x 20cm RODS  
 + 1 x 5cm CAP

H - 5cm  
 H - 20cm  
 H - 20cm  
 H - 20cm  
 H - 20cm  
 H - 20cm



1000464

**STATION W/B**  
**E27**  
**FRAME SIZE**  
 H - 41cm W - 20cm  
 P - 20cm



1000363

**STATION  
 UNDER EAVE**  
**E27**  
**FRAME SIZE**  
 H - 31cm W - 20cm

*IP - 03  
 Rated*

*- Warranty Conditions -*  
 Any claim must be made within 12 Months from the date of purchase.  
 To make a claim, take the product with a Receipt of proof of purchase to retailer.

*- Warranty Exclusions -*  
 1 - Fading due to weather exposure. 2 - Installation within 2km of salt water spray.  
 3 - Damage to product through accident, misuse or negligence.

**Urban  
Exterior  
Range**

**Antique  
Bronze**



1000529

**URBAN  
W/B  
E27**  
FRAME SIZE  
H - 26cm W - 25cm  
P - 43cm

**Globes  
Not Supplied**



**- NOTE -  
Chain  
Pendant  
Is For  
Interior  
Use  
Only  
-  
Supplied  
With A  
1 MT  
Chain**

1000528

**URBAN  
CHAIN PND  
E27**  
FRAME SIZE  
H - 16cm W - 25cm

1000527  
**URBAN  
UNDER EAVE  
E27**  
FRAME SIZE -  
H - 20cm W - 25cm



**Globes  
Not Supplied**

**- NOTE -  
Rod  
Pendant  
Is For  
Exterior  
Use**

1000526

**URBAN  
ROD PND  
E27**  
FRAME SIZE  
H - 16cm W - 25cm  
+ 4 x 20cm RODS  
+ 1 x 5cm CAP

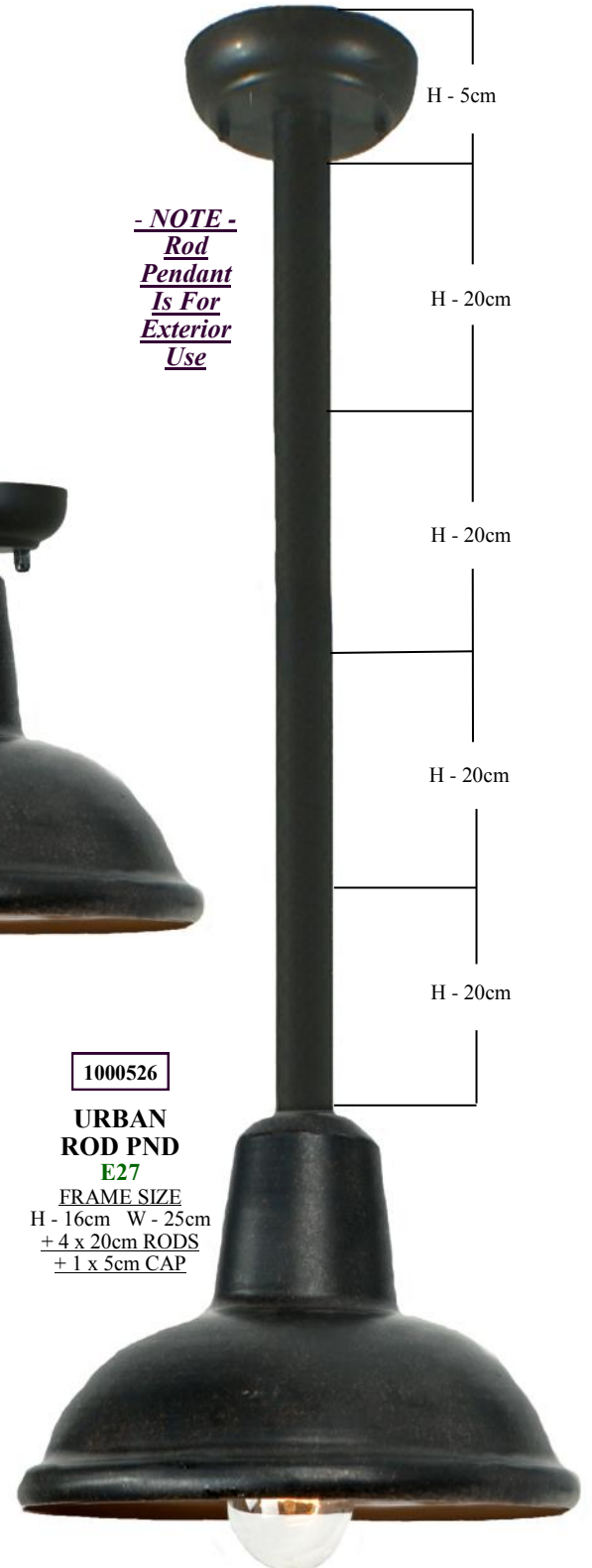

H - 5cm

H - 20cm

H - 20cm

H - 20cm

H - 20cm

**IP - 03  
Rated**

**- Warranty Conditions -**

Any claim must be made within 12 Months from the date of purchase. To make a claim, take the product with a Receipt of proof of purchase to retailer.

**- Warranty Exclusions -**

1 - Fading due to weather exposure. 2 - Installation within 2km of salt water spray. 3 - Damage to product through accident, misuse or negligence.

1000514

**TERMINAL  
W/B**

**E27**

FRAME SIZE

H - 26cm W - 21cm  
P - 25cm



*Terminal  
Exterior  
Range*

*Antique  
Bronze*

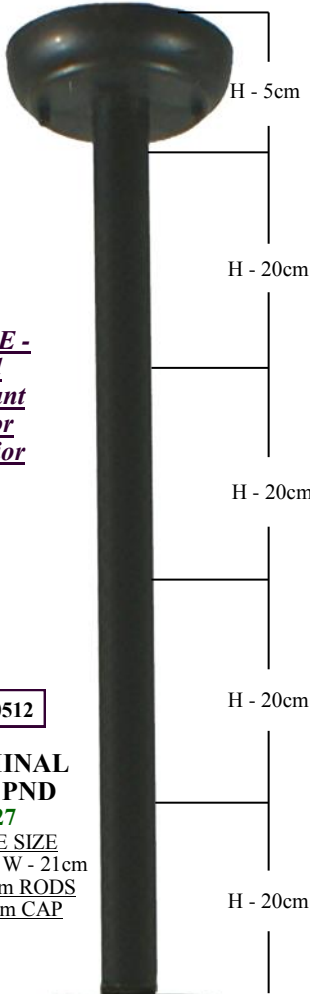

*- NOTE -  
Rod  
Pendant  
Is For  
Exterior  
Use*

1000512

**TERMINAL  
ROD PND**

**E27**

FRAME SIZE

H - 19cm W - 21cm  
+ 4 x 20cm RODS  
+ 1 x 5cm CAP



1000513

**TERMINAL  
UNDER EAVE**

**E27**

FRAME SIZE -

H - 23cm W - 21cm



*- NOTE -  
Chain  
Pendant  
Is For  
Interior  
Use  
Only  
-  
Supplied  
With A  
1 MT  
Chain*

1000510

**TERMINAL  
CHAIN PND**

**E27**

FRAME SIZE

H - 19cm W - 21cm



*IP - 03  
Rated*

**- Warranty Conditions -**

Any claim must be made within 12 Months from the date of purchase.  
To make a claim, take the product with a Receipt of proof of purchase to retailer.

**- Warranty Exclusions -**

1 - Fading due to weather exposure. 2 - Installation within 2km of salt water spray.  
3 - Damage to product through accident, misuse or negligence.

**Port  
Exterior  
Range**

**Antique  
Bronze**



**1000400**

**PORT  
W/B  
E27**  
FRAME SIZE  
H - 33cm W - 22cm  
P - 30cm

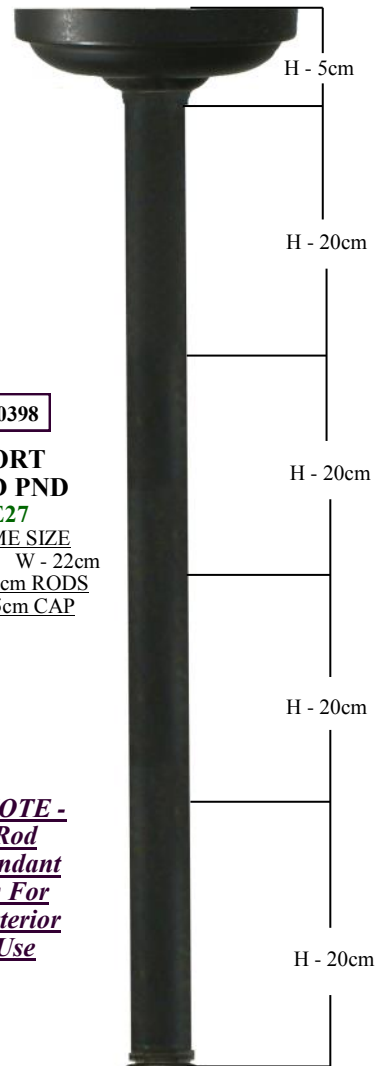

**1000398**

**PORT  
ROD PND  
E27**  
FRAME SIZE  
H - 25cm W - 22cm  
+ 4 x 20cm RODS  
+ 1 x 5cm CAP

**- NOTE -  
Rod  
Pendant  
Is For  
Exterior  
Use**

**- NOTE -  
Chain  
Pendant  
Is For  
Interior  
Use  
Only  
-  
Supplied  
With A  
1 MT  
Chain**

**1001400**

**PORT  
CHAIN PND  
E27**  
FRAME SIZE  
H - 25cm W - 22cm



**Globes  
Not Supplied**



**1000399**

**PORT  
UNDER EAVE  
E27**  
FRAME SIZE -  
H - 29cm W - 22cm

**IP - 44  
Rated**



**- Warranty Conditions -**

Any claim must be made within 12 Months from the date of purchase.  
To make a claim, take the product with a Receipt of proof of purchase to retailer.

**- Warranty Exclusions -**

1 - Fading due to weather exposure. 2 - Installation within 2km of salt water spray.  
3 - Damage to product through accident, misuse or negligence.



# Dockyard Exterior Range

*Antique  
Bronze*

1000149

**DOCKYARD  
W/B**

**E27**

FRAME SIZE

H - 32cm W - 18cm  
P - 21cm



*Globes  
Not Supplied*

*- NOTE -  
Chain  
Pendant  
Is For  
Interior  
Use  
Only  
-  
Supplied  
With A  
1MT  
Chain*

1001149

**DOCKYARD  
CHAIN PND**

**E27**

FRAME SIZE

H - 22cm  
W - 18cm

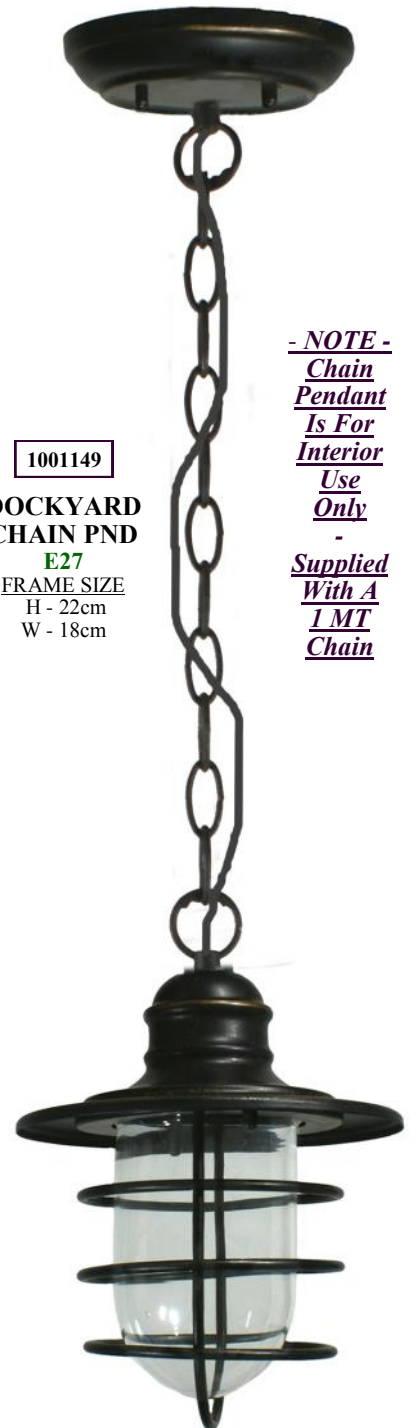

*- NOTE -  
Rod  
Pendant  
Is For  
Exterior  
Use*

1000147

**DOCKYARD  
ROD PND**

**E27**

FRAME SIZE

H - 22cm  
W - 18cm  
+ 4 x 20cm RODS  
+ 1 x 5cm CAP

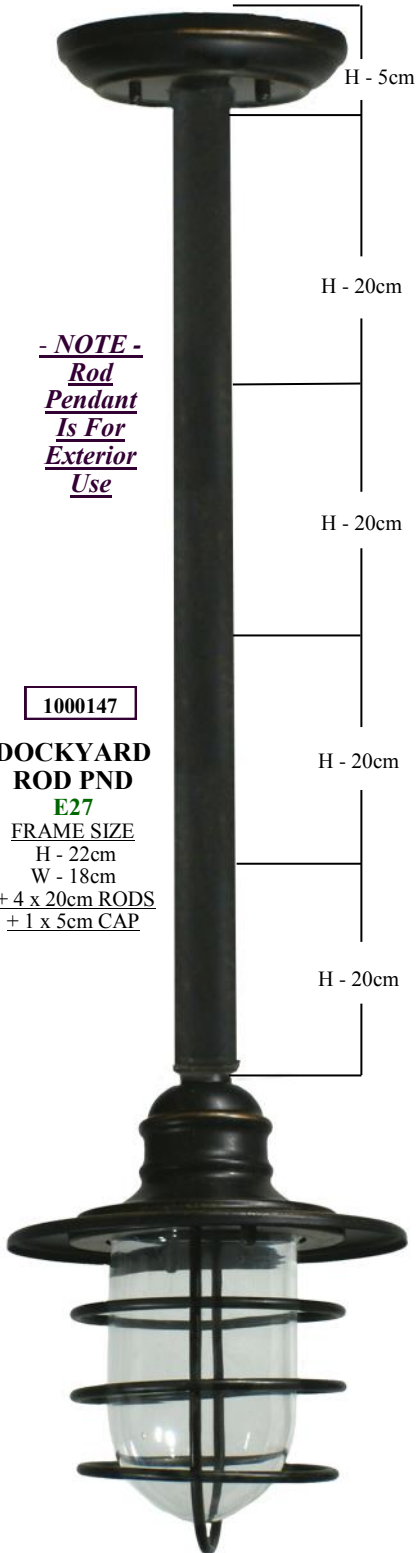

1000148

**DOCKYARD  
UNDER EAVE**

**E27**

FRAME SIZE

H - 24cm W - 18cm

*IP - 55  
Rated*



**- Warranty Conditions -**

Any claim must be made within 12 Months from the date of purchase.  
To make a claim, take the product with a Receipt of proof of purchase to retailer.

**- Warranty Exclusions -**

1 - Fading due to weather exposure. 2 - Installation within 2km of salt water spray.  
3 - Damage to product through accident, misuse or negligence.

**Deckhouse  
Exterior  
Range**

**Screw In  
Glass Shade**

1000146

**DECKHOUSE  
W/B**

**E27**

FRAME SIZE

H - 42cm W - 35cm  
P - 59cm



**Antique  
Bronze**

**- NOTE -  
Chain  
Pendant  
Is For  
Interior  
Use  
Only  
-  
Supplied  
With A  
1 MT  
Chain**

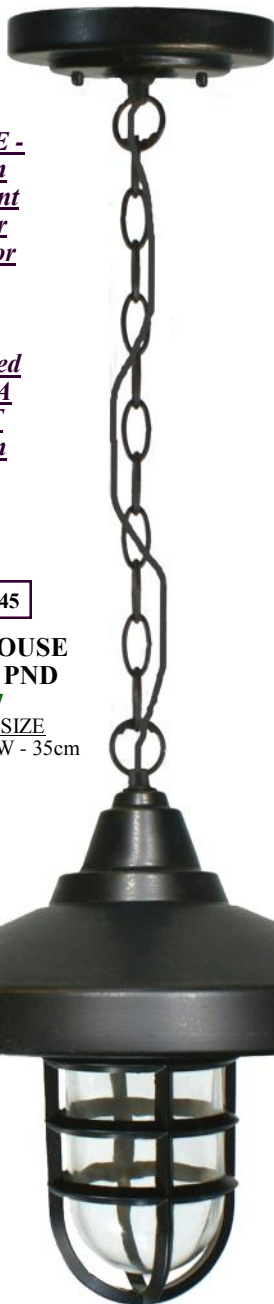

1000145

**DECKHOUSE  
CHAIN PND**

**E27**

FRAME SIZE

H - 29cm W - 35cm



1000144

**DECKHOUSE  
UNDER EAVE**

**E27**

FRAME SIZE

H - 32cm W - 35cm

**IP - 55  
Rated**

H - 5cm

H - 20cm

H - 20cm

H - 20cm

H - 20cm

**- NOTE -  
Rod  
Pendant  
Is For  
Exterior  
Use**



1000143

**DECKHOUSE  
ROD PND E27**

**E27**

FRAME SIZE

H - 29cm W - 35cm  
+ 4 x 20cm RODS  
+ 1 x 5cm CAP

**- Warranty Conditions -**

Any claim must be made within 12 Months from the date of purchase.  
To make a claim, take the product with a Receipt of proof of purchase to retailer.

**- Warranty Exclusions -**

1 - Fading due to weather exposure. 2 - Installation within 2km of salt water spray.  
3 - Damage to product through accident, misuse or negligence.



*IP - 55  
Rated*

*Pier  
Exterior  
Range*

*Antique  
Bronze*

1000397

**PIER W/B**

**E27**

**FRAME**

**SIZE**

H - 35cm W - 24cm  
P - 25cm

*IP - 44  
Rated*



1001221

**GATEWAY W/B**

**E27**

**FRAME**

**SIZE**

H - 28cm W - 12cm  
P - 19cm



*IP - 55  
Rated*

1000596

**WHARF W/B**

**E27**

**FRAME**

**SIZE**

H - 32cm W - 14cm  
P - 21cm

*Wharf  
Exterior  
Range*

*Gateway  
Exterior  
Range*

**Parkway  
Exterior  
Range**

1001395

**PARKWAY  
W/B  
E27  
FRAME SIZE**  
H - 32cm W - 30cm  
P - 35cm

**Antique  
Bronze**

**IP - 44  
Rated**

*Globes  
Not  
Supplied*



**- NOTE -  
Chain  
Pendant  
Is For  
Interior  
Use  
Only  
-  
Supplied  
With A  
1 MT  
Chain**

**- NOTE -  
Rod  
Pendant  
Is For  
Exterior  
Use**

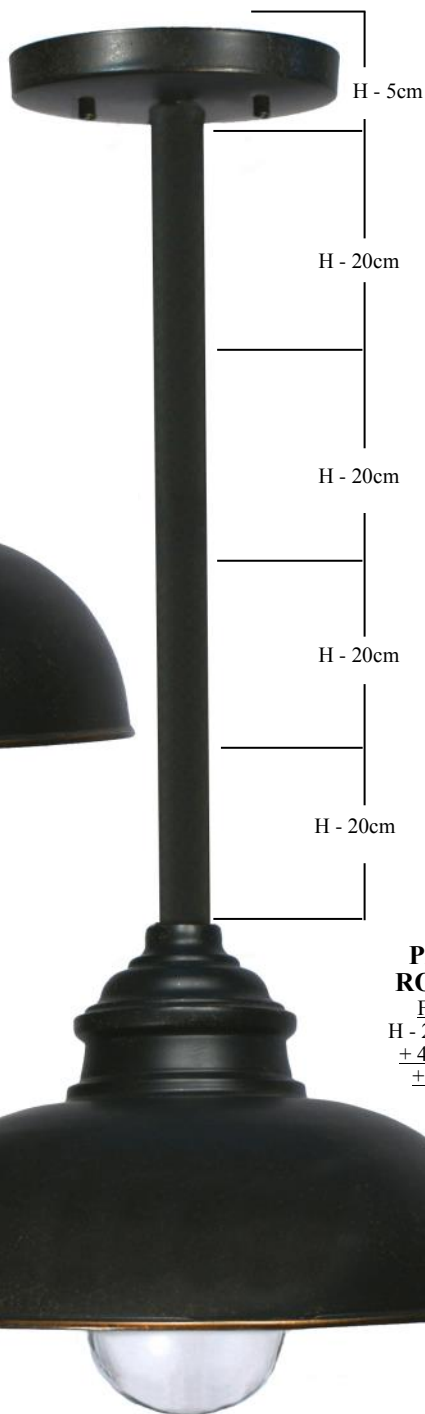

1001392  
**PARKWAY  
CHAIN PND**  
E27  
FRAME SIZE  
H - 28cm  
W - 30cm

1001394  
**PARKWAY  
UNDER EAVE**  
E27  
FRAME SIZE -  
H - 27cm W - 30cm

1001393  
**PARKWAY  
ROD PND E27**  
FRAME SIZE  
H - 24cm W - 30cm  
+ 4 x 20cm RODS  
+ 1 x 5cm CAP

**- Warranty Conditions -**

Any claim must be made within 12 Months from the date of purchase.  
To make a claim, take the product with a Receipt of proof of purchase to retailer.

**- Warranty Exclusions -**

1 - Fading due to weather exposure. 2 - Installation within 2km of salt water spray.  
3 - Damage to product through accident, misuse or negligence.

**Causeway  
Exterior  
Range**

1001113

**CAUSEWAY**

**W/B**

**E27**

**FRAME SIZE**

H - 37cm W - 29cm  
P - 40cm



*Globes  
Not  
Supplied*

**Antique  
Bronze**

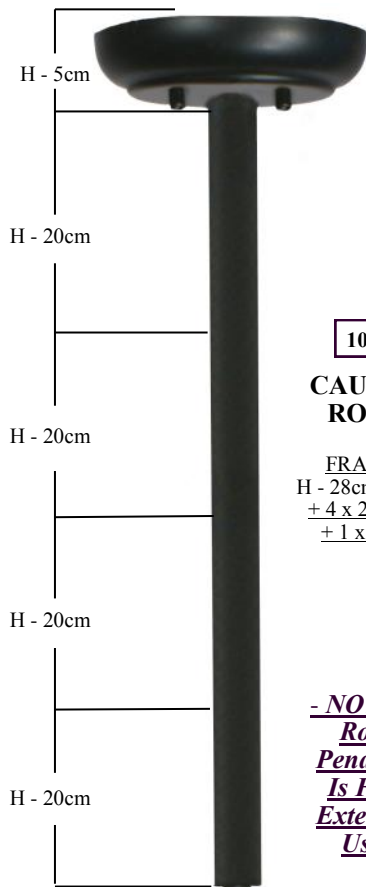

1001111

**CAUSEWAY  
ROD PND**

**E27**

**FRAME SIZE**

H - 28cm W - 29cm  
+ 4 x 20cm RODS  
+ 1 x 5cm CAP

*- NOTE -  
Rod  
Pendant  
Is For  
Exterior  
Use*



*- NOTE -  
Chain  
Pendant  
Is For  
Interior  
Use  
Only  
-  
Supplied  
With A  
1MT  
Chain*

1001112

**CAUSEWAY  
UNDER EAVE**

**E27**

**FRAME SIZE -**

H - 32cm W - 29cm

**IP - 44  
Rated**

1001110

**CAUSEWAY  
CHAIN PND**

**E27**

**FRAME SIZE**

H - 34cm W - 29cm



**- Warranty Conditions -**

Any claim must be made within 12 Months from the date of purchase.  
To make a claim, take the product with a Receipt of proof of purchase to retailer.

**- Warranty Exclusions -**

**100** 1 - Fading due to weather exposure. 2 - Installation within 2km of salt water spray.  
3 - Damage to product through accident, misuse or negligence.

**Riverside  
Exterior  
Range**

**Antique  
Black**

**New  
Range**



**1001411**  
**RIVERSIDE  
BLACK  
CHAIN PND**  
**E27**  
FRAME SIZE  
H - 23cm  
W - 21cm

**IP - 03  
Rated**



**1001410**  
**RIVERSIDE BLACK W/B E27**  
FRAME SIZE  
H - 33cm W - 21cm P - 28cm



**1001412**  
**RIVERSIDE  
BLACK  
ROD PND**  
**E27**  
FRAME SIZE  
H - 21cm W - 21cm  
+ 4 x 20cm RODS  
+ 1 x 5cm CAP



**1001413**  
**RIVERSIDE  
BLACK  
UNDER EAVE**  
**E27**  
FRAME SIZE  
H - 24cm W - 21cm

**Antique  
Bronze**

**New  
Range**



**1001415**  
**RIVERSIDE  
BRONZE  
CHAIN PND**  
**E27**  
FRAME SIZE  
H - 23cm  
W - 21cm



**1001414**  
**RIVERSIDE BRONZE W/B E27**  
FRAME SIZE  
H - 33cm W - 21cm P - 28cm



**1001416**  
**RIVERSIDE  
BRONZE  
ROD PND**  
**E27**  
FRAME SIZE  
H - 21cm W - 21cm  
+ 4 x 20cm RODS  
+ 1 x 5cm CAP



**1001417**  
**RIVERSIDE  
BRONZE  
UNDER EAVE**  
**E27**  
FRAME SIZE  
H - 24cm W - 21cm

**IP - 03  
Rated**

**- Warranty Conditions -**

Any claim must be made within 12 Months from the date of purchase. To make a claim, take the product with a Receipt of proof of purchase to retailer.

**- Warranty Exclusions -**

1 - Fading due to weather exposure. 2 - Installation within 2km of salt water spray. 3 - Damage to product through accident, misuse or negligence.

**Southby  
Exterior  
Range**

**Antique  
Bronze**

1000443

**SOUTHBY  
W/B  
E27  
FRAME SIZE  
H - 31cm W - 21cm  
P - 26cm**



**- NOTE -  
Chain  
Pendant  
Is For  
Interior  
Use  
Only  
-  
Supplied  
With A  
1 MT  
Chain**

**- NOTE -  
Rod  
Pendant  
Is For  
Exterior  
Use**

1000444  
**SOUTHBY  
CHAIN PND  
E27  
FRAME SIZE  
H - 22cm  
W - 21cm**



1000442  
**SOUTHBY  
UNDER EAVE  
E27  
FRAME SIZE  
H - 22cm W - 21cm**



1000463  
**SOUTHBY  
ROD PND  
E27  
FRAME SIZE  
H - 22cm W - 21cm  
+ 4 x 20cm RODS  
+ 1 x 5cm CAP**

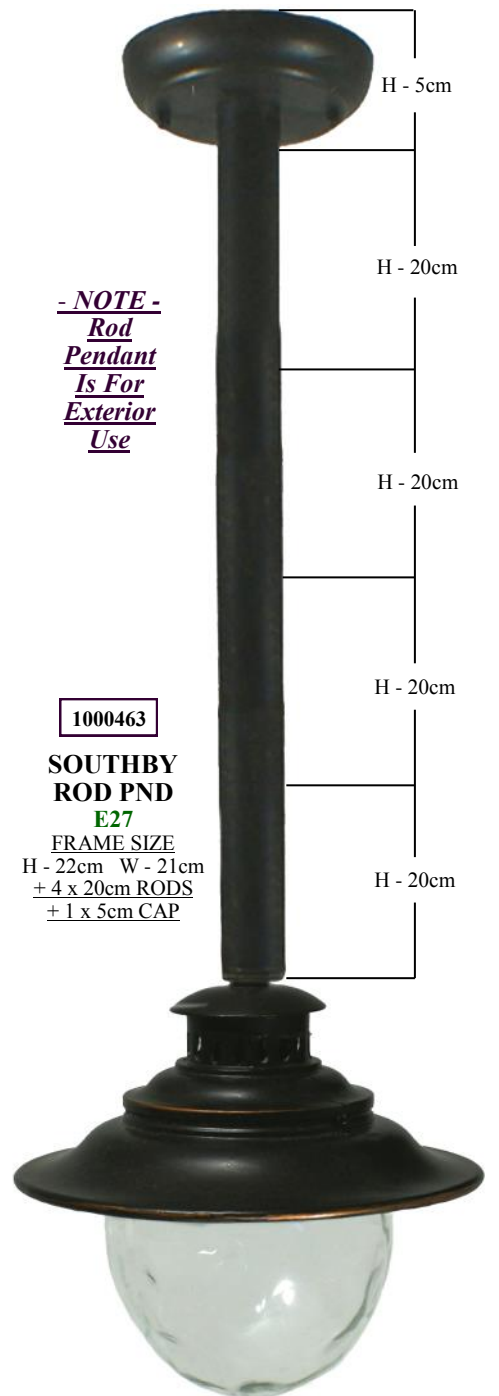

**IP - 44  
Rated**

**- Warranty Conditions -**

Any claim must be made within 12 Months from the date of purchase.  
To make a claim, take the product with a Receipt of proof of purchase to retailer.

**- Warranty Exclusions -**

1 - Fading due to weather exposure. 2 - Installation within 2km of salt water spray.  
3 - Damage to product through accident, misuse or negligence.

*Frontage  
Exterior  
Range*

*Antique  
Black*

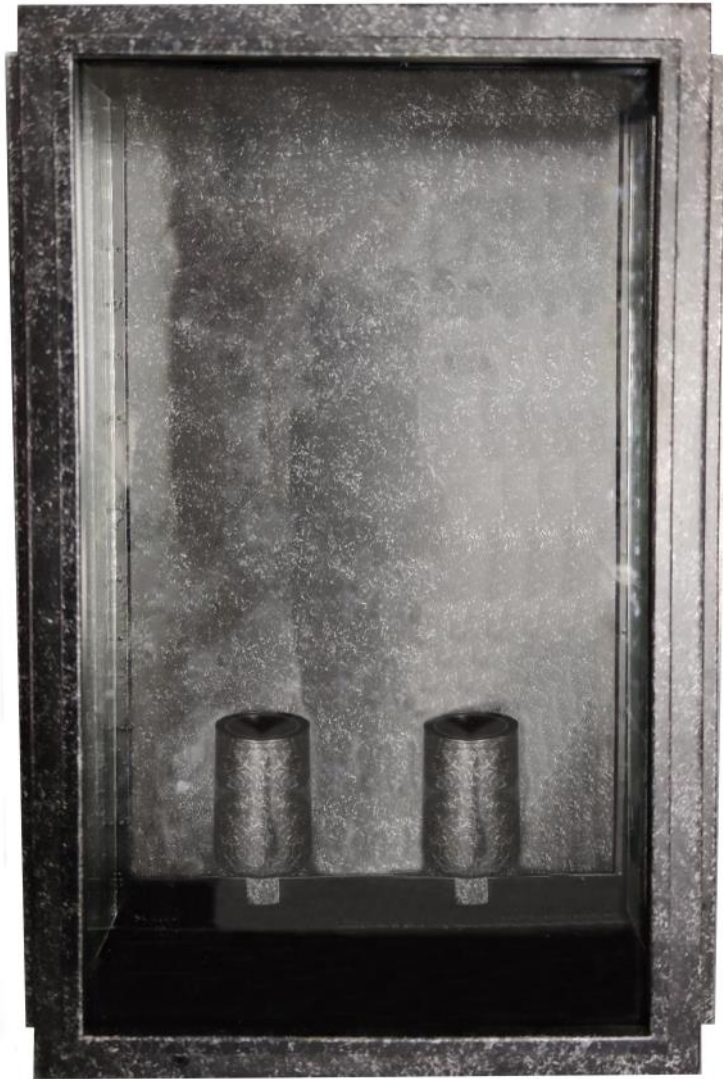

1001213

**FRONTAGE LARGE  
WALL SCONCE E27**

FRAME SIZE  
H - 440mm W - 277mm P - 143mm

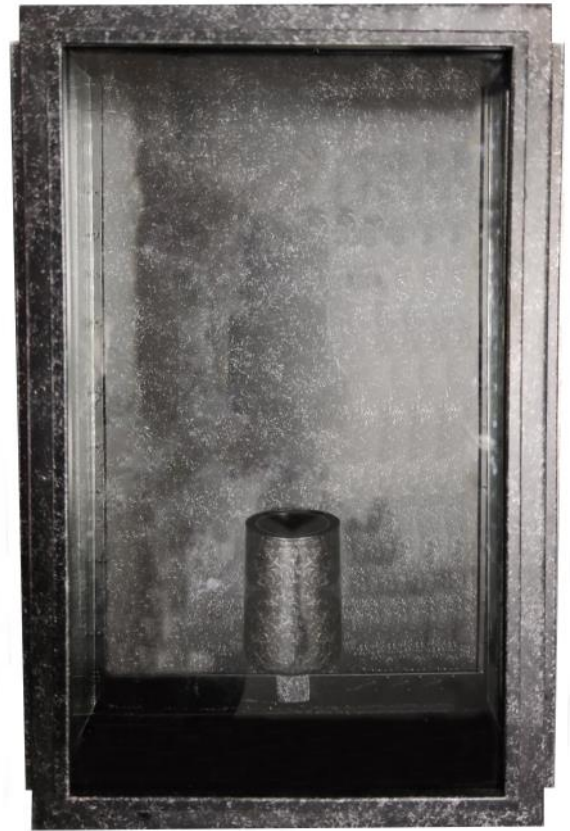

1001214

**FRONTAGE MEDIUM  
WALL SCONCE E27**

FRAME SIZE  
H - 342mm W - 220mm P - 117mm

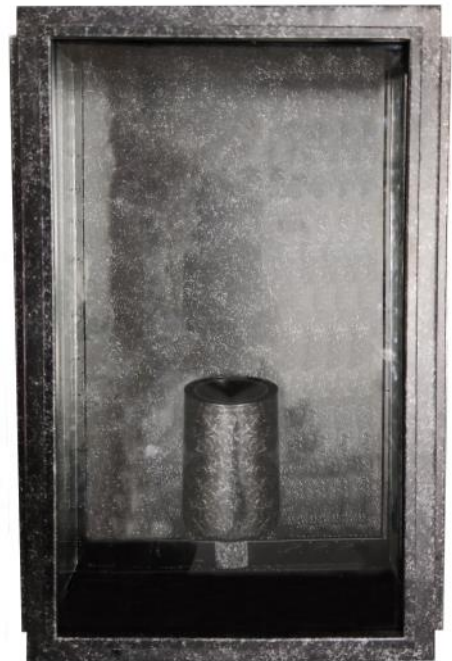

1001215

**FRONTAGE SMALL  
WALL SCONCE E27**

FRAME SIZE  
H - 256mm W - 165mm P - 88mm

*IP - 44  
Rated*

*- Warranty Conditions -*

Any claim must be made within 12 Months from the date of purchase.  
To make a claim, take the product with a Receipt of proof of purchase to retailer.

*- Warranty Exclusions -*

1 - Fading due to weather exposure. 2 - Installation within 2km of salt water spray.  
3 - Damage to product through accident, misuse or negligence.



*Montrose  
& Loft  
Exterior  
Range*

*Antique  
Bronze*



1000338

**MONTROSE SMALL  
WALL SCONCE E27**

FRAME SIZE -  
H - 35cm W - 22cm P - 12cm



1000340

**MONTROSE LARGE  
WALL SCONCE E27**

FRAME SIZE -  
H - 45cm W - 28cm P - 14cm



1000293

**LOFT  
WALL SCONCE E27**

FRAME SIZE -  
H - 34cm W - 15cm P - 12cm

*IP - 44  
Rated*

*- Warranty Conditions -*

Any claim must be made within 12 Months from the date of purchase.  
To make a claim, take the product with a Receipt of proof of purchase to retailer.

*- Warranty Exclusions -*

104 1 - Fading due to weather exposure. 2 - Installation within 2km of salt water spray.  
3 - Damage to product through accident, misuse or negligence.

*Wickham  
Exterior  
Range*

*Antique  
Bronze*



1000599

**WICKHAM  
ANTIQUE BRONZE  
UNDER EAVE 2/LT**

**E27**

**FRAME SIZE  
H - 21cm W - 35cm**

*IP - 44  
Rated*

*Antique  
Black*



1000598

**WICKHAM  
ANTIQUE BLACK  
UNDER EAVE 2/LT**

**E27**

**FRAME SIZE  
H - 21cm W - 35cm**

*IP - 44  
Rated*

**- Warranty Conditions -**

Any claim must be made within 12 Months from the date of purchase.  
To make a claim, take the product with a Receipt of proof of purchase to retailer.

**- Warranty Exclusions -**

1 - Fading due to weather exposure. 2 - Installation within 2km of salt water spray.  
3 - Damage to product through accident, misuse or negligence.

# Exterior Accessory Range

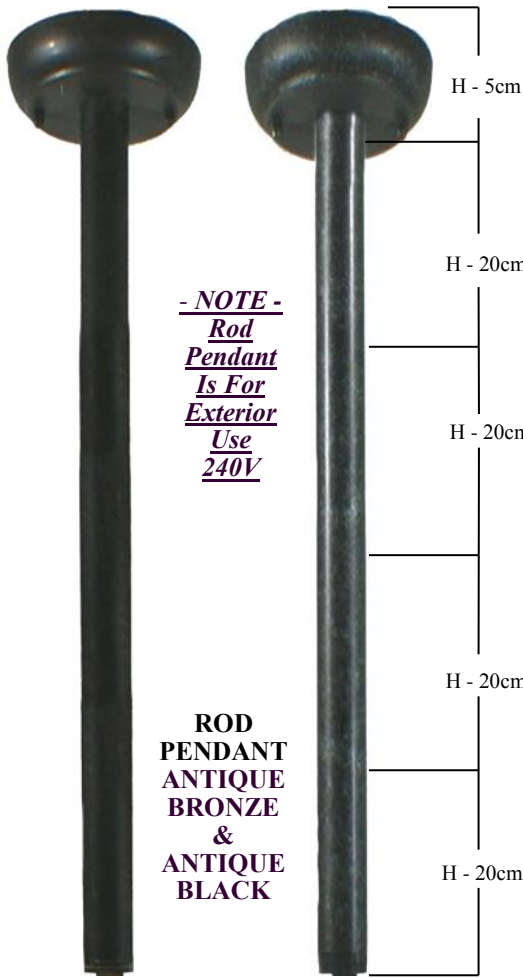

**- NOTE -  
Rod  
Pendant  
Is For  
Exterior  
Use  
240V**

**ROD  
PENDANT  
ANTIQUE  
BRONZE  
&  
ANTIQUE  
BLACK**

1000270

1000272



**1000259**      **1000260**  
**UNDER EAVES PLATE**  
**ANTIQUE BRONZE - ANTIQUE BLACK**  
**FRAME SIZE - H - 3cm W - 13cm**

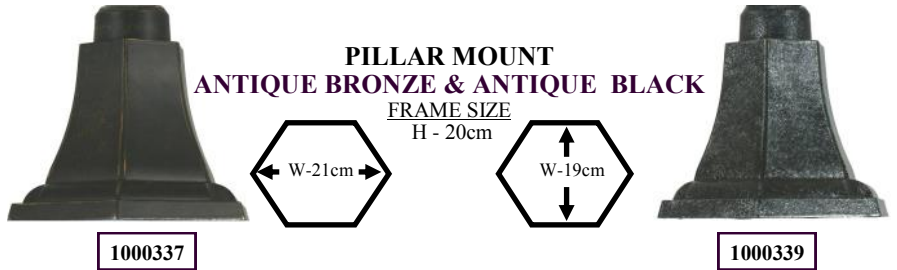

**PILLAR MOUNT**  
**ANTIQUE BRONZE & ANTIQUE BLACK**  
**FRAME SIZE**  
**H - 20cm**

1000337

1000339

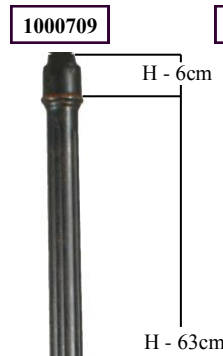

1000709

H - 6cm



1000708

H - 63cm

**STANDARD  
POST  
ANTIQUE  
BRONZE  
&  
ANTIQUE  
BLACK  
TOTAL  
HEIGHT  
182cm**

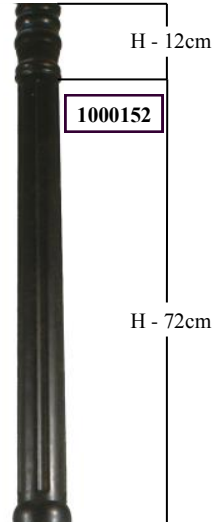

1000152

H - 12cm



1000151

**DOMAIN  
POST  
ANTIQUE  
BRONZE  
&  
ANTIQUE  
BLACK  
TOTAL  
HEIGHT  
226cm**

H - 72cm

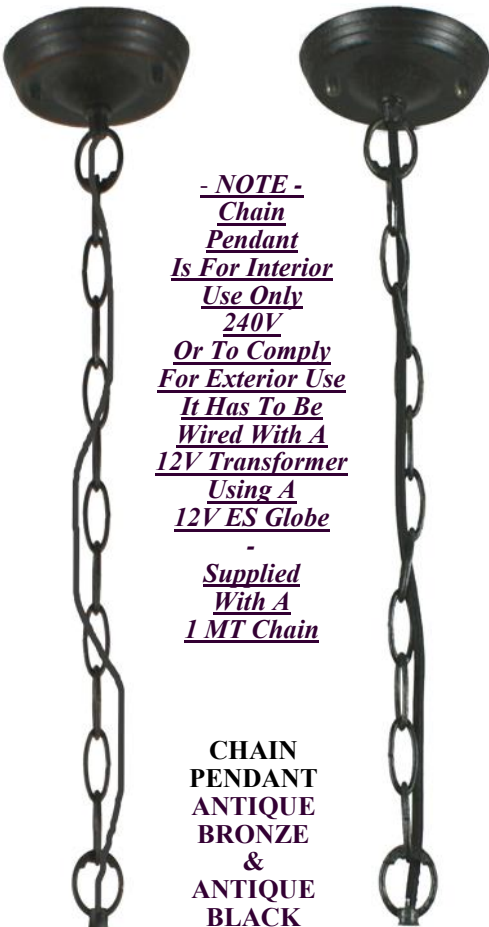

**- NOTE -  
Chain  
Pendant  
Is For Interior  
Use Only  
240V  
Or To Comply  
For Exterior Use  
It Has To Be  
Wired With A  
12V Transformer  
Using A  
12V ES Globe  
-  
Supplied  
With A  
1 MT Chain**

**CHAIN  
PENDANT  
ANTIQUE  
BRONZE  
&  
ANTIQUE  
BLACK**

1000306

1000308



H - 60cm



H - 53cm



H - 42cm

H - 40cm

H - 60cm



**- Warranty Conditions -**



Any claim must be made within 12 Months from the date of purchase.  
To make a claim, take the product with a Receipt of proof of purchase to retailer.

**- Warranty Exclusions -**

1 - Fading due to weather exposure. 2 - Installation within 2km of salt water spray.  
3 - Damage to product through accident, misuse or negligence.

# IP Rating Chart

IP ratings are represented by combining the first and second digits of the following columns. See example below.

1st Digit - SOLID Degree of protection against solid objects	2nd Digit - LIQUID Degree of protection against water
 <b>0</b> No Protection	 <b>0</b> No Protection
 <b>1</b> Protected against a solid object greater than 50mm, such as a hand.	 <b>1</b> Protected against water drops.
 <b>2</b> Protected against a solid object greater than 12.5mm, such as a finger.	 <b>2</b> Protected against water drops at a 15 degree angle.
 <b>3</b> Protected against a solid object greater than 2.5mm, such as a wire.	 <b>3</b> Protected against water spray at 60 degree angle.
 <b>4</b> Protected against a solid object greater than 1.0mm, such as a thin strap.	 <b>4</b> Protected against water splashing from any angle.
 <b>5</b> Dust Protected. Prevents ingress of dust sufficient to cause harm.	 <b>5</b> Protected against water jets from any angle.
 <b>6</b> Dust tight. No ingress of dust.	 <b>6</b> Protected against powerful water jets and heavy seas.
<b>Example:</b>  <b>IP 6 5</b>	 <b>7</b> Protected against the effects of temporary submersion in water. (30 minutes at 3 feet)
	 <b>8</b> Protected against the effects of permanent submersion in water. (Up to 13 feet)

## Difference Between Crystal and Glass

**Key difference:** Glass is a generic name, while, crystal is a subcategory of glass, made in the same manner as glass but with different materials.

Hence, all crystal is glass, but not all glass is crystal.

Scientifically, crystals are pure substances whose atoms, molecules, or ions are arranged in an ordered pattern, where they extend in all three spatial dimensions. Crystals most commonly occur naturally on the earth, though the process of crystal formation via mechanisms of crystal growth is called crystallization or solidification.

While, referring in the same context as glass, crystal refers to well glass. The term crystal is often used to refer to glassware that has a more elegant form than the normal or everyday glassware. However, that is not the official difference between the two. Actually, there is no official clean cut definition of crystal.

Still, the general rule that applies is that crystal is a type of glass that contains lead.

There are three primary criteria for crystal as established by the European Union in 1969: a lead content in excess of 24%, a density in excess of 2.90 and a reflective index of 1.545. However, outside of the European Union, this definition is usually disregarded. In the United States, any glass with more than 1% of lead content is termed as crystal.

Technically, the application of the term 'crystal' to glass is in itself inaccurate, as glass is an amorphous solid. Hence, by definition it lacks a crystalline structure, which is necessary for a crystal. Still, the term, even though erroneously applied to glass, has stuck around and remains popular.

The color and brilliance of glass often varies, depending on its content. Glass made with iron tends to have a green tinge, while glass made with soda-lime will have an aqua tinge. While, some find these tinges to be unattractive, glasses with a greenish hue tend to be considerably stronger. Crystals generally are light in color and are mostly translucent. Some clear crystals have the properties of reflecting light into different colors.

When held in the right position, the refraction and dispersion of light from crystal will create a rainbow of hues.

So, in summation, glass is a generic name, while, crystal is a subcategory of glass, made in the same manner as glass but with different materials. Hence, all crystal is glass, but not all glass is crystal.

### Type of globes required for all our light fittings

**E14 - E27 - B15 - B22 indicated on all light fittings LED compatible**

LED WATTS	INCANDESCENT WATTS (equivalent)	Not available in Australia	LIGHT OUTPUT LUMENS	LIGHTING INSPIRATIONS PRODUCT ADEQUATE LIGHT LEVELS
4-5	-	25-40	-	450 Approx - To suit all multi arm globe fittings.
6-8	-	60	-	750 - 900 Approx - To suit 1/LT wall brackets, 2/LT, 3LT multi arm, 1/LT lanterns and exteriors.
9-13	-	75-100	-	1100-1300 Approx - To suit 1/LT lanterns & pendants, rod sets and exteriors.

**NOTE - Please advise your customers that the longevity of the globe is related to the quality of them. Please purchase high quality globes.**

*Classic Style Table Lamp.  
Duplex Glassware With Chrome Or Bronze Finish*

*Table Lamp  
Range*



1000082

**BANKERS TABLE LAMP BRONZE GREEN E14**  
FRAME SIZE - H - 330mm W - 270mm D - 200mm

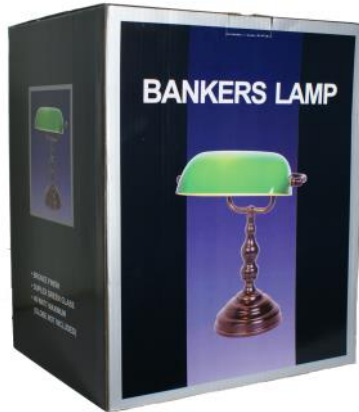

1000083

**BANKERS TABLE LAMP CHROME OPAL E14**  
FRAME SIZE - H - 330mm W - 270mm D - 200mm



1000085

**STUDY TABLE LAMP CHROME OPAL E14**  
FRAME SIZE - H - 430mm W - 270mm D - 200mm

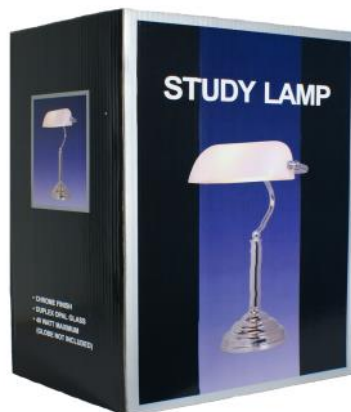

1000084

**STUDY TABLE LAMP BRONZE GREEN E14**  
FRAME SIZE - H - 430mm W - 270mm D - 200mm

# Accessories In Polished Brass



3006061

2 1/4" GALLERY  
BRASS -29mm HOLE



3006062

3 1/4" GALLERY  
BRASS -29mm HOLE



3006063

4 1/4" GALLERY  
BRASS -29mm HOLE

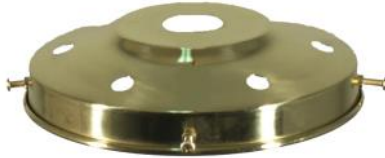

3006064

6 1/4" GALLERY  
BRASS -29mm HOLE



3006065

8 1/4" GALLERY  
BRASS -29mm HOLE



3006060

12 1/4" GALLERY  
BRASS -29mm HOLE



3006008

ANGLE CANOPY  
BRASS  
H-80mm W-100mm



3006054

FAN KIT BRASS B22  
TO SUIT  
2 1/4" - 3 1/4" - 4 1/4" - 6 1/4"  
8 1/4" - 12 1/4" GALLERY



3006013

BATTEN COVER  
BRASS -29mm HOLE

## Brass



3006022

CEILING  
HOOK 1/2"



3006023

CEILING  
HOOK 3/4"



3006071

ROD  
& JOINER  
1/2" x 1/2MT  
BRASS B22



3006072

ROD  
& JOINER  
3/4" x 1/2MT  
BRASS B22



3006071

ROD  
& JOINER  
1/2" x 1/2MT  
BRASS B22



3006072

ROD  
& JOINER  
3/4" x 1/2MT  
BRASS B22

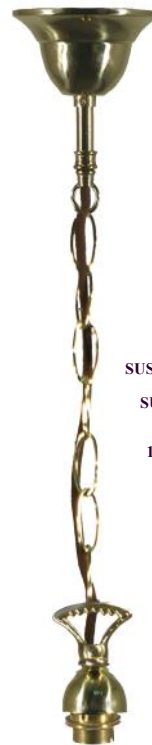

3006092

CHAIN SUSP  
BROWN CORD  
1 MT  
BRASS B22

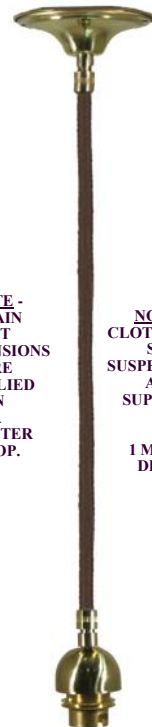

3006037

CLOTH  
BROWN CORD  
SUSP 1 MT  
BRASS B22



3006006

3 CHAIN SUSP  
BROWN CORD  
W-HOOKS 1 MT  
BRASS B22

NOTE -  
CHAIN  
SET  
SUSPENSIONS  
ARE  
SUPPLIED  
IN  
A  
1 METER  
DROP.

NOTE -  
CLOTH CORD  
SET  
SUSPENSIONS  
ARE  
SUPPLIED  
IN  
A  
1 METER  
DROP.

3006087

ROD SET  
1/2" x 1/2MT  
BRASS B22

3006089

ROD SET  
3/4" x 1/2MT  
BRASS B22

3006073

ASTON ROD SET  
1/2" x 1/2MT  
BRASS E27

3006075

ASTON ROD SET  
3/4" x 1/2MT  
BRASS E27

# Wall Bracket Range

## Brass



3000327

**7011 WALL SCONCE  
BRASS B22**  
H-33cm W-15cm  
P-10cm



3000332

**WAUBRA  
1/LT W/B BRASS  
5008 29mm FROST  
ETCHED B22**  
H - 20cm W - 14cm P - 18cm



3000334

**WAUBRA 1/LT W/B BRASS  
CONO OPAL MATT B22**  
H-20cm W-14cm P-19cm



3000333

**WAUBRA 1/LT W/B BRASS  
CONO CLEAR B22**  
H-20cm W-14cm P-19cm



3000154

**KOSCINA 1/LT W/B BRASS  
CONO OPAL MATT B22**  
H-20cm W-14cm P-16cm



3000153

**KOSCINA 1/LT W/B BRASS  
CONO CLEAR B22**  
H-20cm W-14cm P-16cm



3000336

**KLINE 1/LT W/B BRASS  
ZIPPER 23 FROST B22**  
H-22cm W-12cm P-16cm



3000155

**KOSCINA 1/LT W/B BRASS  
DECATRON OPAL MATT B22**  
H-19cm W-12cm P-16cm



3000335

**KLINE 1/LT W/B BRASS  
ZIPPER 23 CLEAR B22**  
H-22cm W-12cm P-16cm



3000175

**LOXTON 1/LT W/B BRASS  
CONO OPAL MATT B22**  
H - 22cm W - 14cm P - 22cm



3000180

**LOXTON 1/LT W/B BRASS  
DECATRON OPAL MATT B22**  
H - 22cm W - 12cm P - 21cm



3000175

**LOXTON 1/LT W/B BRASS  
CONO CLEAR B22**  
H - 22cm W - 14cm P - 22cm

*Luke  
Range*



3000189

LUKE  
3/LT PND BRASS  
SHEFFIELD 6" B22  
H - 66cm (ADJ)  
W - 52cm



3000187

LUKE  
1/LT W/B BRASS  
SHEFFIELD 6" B22  
H - 32cm W - 15cm  
P - 26cm

*Brass*



3000191

LUKE  
5/LT PND BRASS  
SHEFFIELD 6" B22  
H - 66cm (ADJ)  
W - 56cm

**NOTE -**  
ALL  
PENDANTS  
ARE  
SUPPLIED  
WITH A  
1/2 MT DROP.  
HALF  
METER  
1/2"  
ROD  
&  
JOINER  
EXTENSIONS  
AVAILABLE





3000188

**LUKE**  
**3/LT PND BRASS**  
**SPHERE 6" OPAL GLOSS**  
**B22**  
H - 66cm (ADJ)  
W - 52cm

***Luke***  
***Range***

3000186

**LUKE**  
**1/LT W/B BRASS**  
**SPHERE 6" OPAL GLOSS**  
**B22**  
H - 32cm W - 15cm  
P - 26cm



***Brass***

3000190

**LUKE**  
**5/LT PND BRASS**  
**SPHERE 6" OPAL GLOSS**  
**B22**  
H - 66cm (ADJ)



**NOTE -**  
**ALL**  
**PENDANTS**  
**ARE**  
**SUPPLIED**  
**WITH A**  
**1/2 MT DROP.**  
**HALF**  
**METER**  
**1/2"**  
**ROD**  
**&**  
**JOINER**  
**EXTENSIONS**  
**AVAILABLE**

# Victoriana Range

3000320

VICTORIANA  
3/LT PND BRASS  
5008 29mm B22  
H - 75cm (ADJ)  
W - 62cm



3000316

VICTORIANA  
1/LT W/B BRASS  
5008 29mm B22  
H - 20cm W - 12cm  
P - 29cm



**NOTE -**  
ALL  
PENDANTS  
ARE  
SUPPLIED  
WITH A  
1/2 MT DROP.  
HALF  
METER  
1/2"  
ROD  
&  
JOINER  
EXTENSIONS  
AVAILABLE

## Brass

3000324

VICTORIANA  
5/LT PND BRASS  
5008 29mm B22  
H - 75cm (ADJ)  
W - 67cm



# Sphere Range



3000039

**SPHERE 12" OPAL GLOSS B/F BRASS B22**  
H-34cm W-30cm



3000035

**SPHERE 10" OPAL GLOSS B/F BRASS B22**  
H-28cm W-25cm



3000044

**SPHERE 8" OPAL GLOSS B/F BRASS B22**  
H-22cm W-20cm



3000029

**SPHERE 6" OPAL GLOSS B/F BRASS B22**  
H-17cm W-15cm

**NOTE -**  
HALF METER 1/2" & 3/4" ROD & JOINER EXTENSIONS AVAILABLE



3000278

**SPHERE 12" OPAL GLOSS ROD PND 3/4" BRASS B22**  
H-86cm (ADJ) W-30cm



3000242

**SPHERE 10" OPAL GLOSS ROD PND 1/2" BRASS B22**  
H-80cm (ADJ) W-25cm

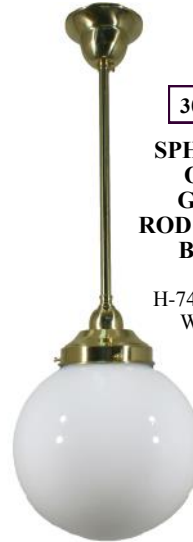

3000254

**SPHERE 8" OPAL GLOSS ROD PND 1/2" BRASS B22**  
H-74cm (ADJ) W-20cm

**NOTE -**  
CHAIN SET SUSPENSIONS ARE SUPPLIED IN A 1 METER DROP.

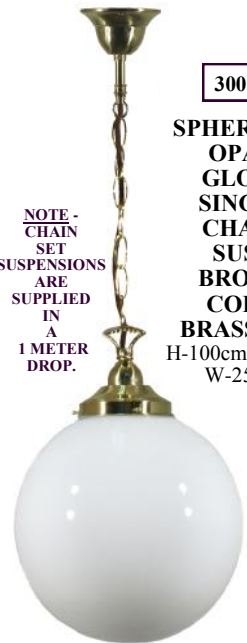

3001190

**SPHERE 10" OPAL GLOSS SINGLE CHAIN SUSP BROWN CORD BRASS B22**  
H-100cm +(ADJ) W-25cm



3000040

**SHEFFIELD 12" B/F BRASS B22**  
H-34cm W-30cm



3000037

**SHEFFIELD 10" B/F BRASS B22**  
H-28cm W-25cm



3000047

**SHEFFIELD 8" B/F BRASS B22**  
H-22cm W-20cm



3000032

**SHEFFIELD 6" B/F BRASS B22**  
H-17cm W-15cm



3000281

**SHEFFIELD 12" ROD PND 3/4" BRASS B22**  
H-86cm (ADJ) W-30cm

**NOTE -**  
HALF METER 1/2" & 3/4" ROD & JOINER EXTENSIONS AVAILABLE



3000245

**SHEFFIELD 10" ROD PND 1/2" BRASS B22**  
H-80cm (ADJ) W-25cm

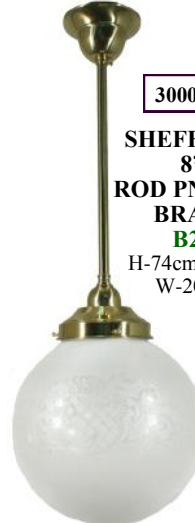

3000258

**SHEFFIELD 8" ROD PND 1/2" BRASS B22**  
H-74cm (ADJ) W-20cm

**NOTE -**  
CHAIN SET SUSPENSIONS ARE SUPPLIED IN A 1 METER DROP.



3001191

**SHEFFIELD 10" SINGLE CHAIN SUSP BROWN CORD BRASS B22**  
H-100cm +(ADJ) W-25cm

*Brass*

# St Kilda Range

# Brass

NOTE - CHAIN SET SUSPENSIONS ARE SUPPLIED IN A 1 METER DROP.

3000095

ST KILDA 8" OPAL MATT SINGLECHAIN BROWN CORD SUSP BRASS B22  
H-100cm(ADJ)  
W-21cm

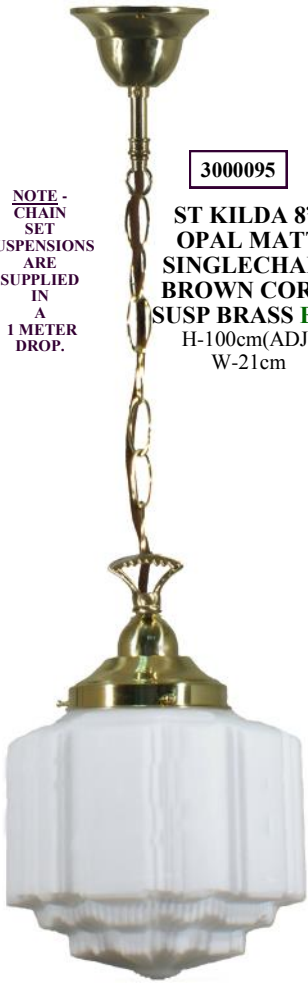

NOTE - CLOTH CORD SET SUSPENSIONS ARE SUPPLIED IN A 1 METER DROP.

3000113

ST KILDA 8" OPAL MATT CLOTH BROWN CORD SUSP BRASS B22  
H-100cm(ADJ)  
W-21cm



3000262

ST KILDA 8" OPAL MATT ROD PND 1/2" BRASS B22  
H-73cm(ADJ)



NOTE - HALF METER 1/2" & 3/4" ROD & JOINER EXTENSIONS AVAILABLE

3000286

ST KILDA 14" OPAL MATT ROD PND 3/4" BRASS B22  
H-75cm(ADJ)  
W-36cm



3000051

ST KILDA 8" OPAL MATT B/F BRASS B22  
H-22cm W-21cm



3000013

ST KILDA 14" OPAL MATT 3 CHAIN SUSP BRASS B22  
H-100cm (ADJ)  
W-34cm

NOTE - 3 CHAIN SUSPENSION ARE SUPPLIED IN A 1 METER DROP WITH HOOKS



3000019

ST KILDA 14" OPAL MATT B/F BRASS B22  
H-29cm W-36cm



# Senator Range

## Brass

3001112

**SENATOR 17"**  
**OPAL MATT**  
**3 CHAIN**  
**SUSP**  
**BRASS B22**  
H-100cm (ADJ)  
W-42cm



3000012

**SENATOR 14"**  
**OPAL MATT**  
**3 CHAIN**  
**SUSP**  
**BRASS B22**  
H-100cm (ADJ)  
W-34cm



3000009

**SENATOR 11"**  
**OPAL MATT**  
**3 CHAIN**  
**SUSP**  
**BRASS B22**  
H-100cm (ADJ)  
W-28cm



3000111

**SENATOR 8"**  
**OPAL**  
**MATT**  
**CLOTH**  
**BROWN**  
**CORD SUSP**  
**BRASS B22**  
H-100cm(ADJ)  
W-20cm

**NOTE -**  
**CLOTH CORD**  
**SET**  
**SUSPENSIONS**  
**ARE**  
**SUPPLIED**  
**IN**  
**A**  
**1 METER**  
**DROP.**



3000257

**SENATOR 8"**  
**OPAL MATT**  
**ROD PND**  
**1/2"**  
**BRASS B22**  
H-75cm (ADJ)  
W-20cm



**NOTE -**  
**HALF**  
**METER**  
**1/2" & 3/4"**  
**ROD**  
**&**  
**JOINER**  
**EXTENSIONS**  
**AVAILABLE**

3000285

**SENATOR 14"**  
**OPAL MATT**  
**ROD PND**  
**3/4"**  
**BRASS B22**  
H-75cm(ADJ)  
W-36cm



3000247

**SENATOR**  
**11"**  
**OPAL**  
**MATT**  
**ROD PND**  
**1/2"**  
**BRASS B22**  
H-70cm(ADJ)  
W-28cm



3000093

**SENATOR**  
**8"**  
**OPAL**  
**MATT**  
**SINGLE**  
**CHAIN**  
**BROWN**  
**CORD**  
**SUSP**  
**BRASS B22**  
H-100cm  
W-20cm

**NOTE -**  
**CHAIN**  
**SET**  
**SUSPENSIONS**  
**ARE**  
**SUPPLIED**  
**IN**  
**A**  
**1 METER**  
**DROP.**

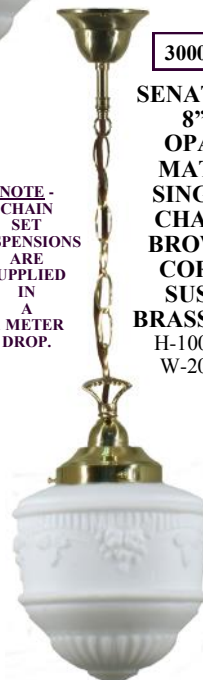

3000018

**SENATOR 14"**  
**OPAL MATT**  
**B/F BRASS B22**  
H-32cm W-36cm



3000067

**SENATOR 11"**  
**OPAL MATT**  
**B/F BRASS B22**  
H-28cm W-28cm



3000046

**SENATOR 8"**  
**OPAL MATT**  
**B/F BRASS B22**  
H-23cm W-20cm



# Empire Range

# Brass



**3001111**  
**EMPIRE 8" OPAL MATT CLOTH BROWN CORD SUSP BRASS B22**  
 H-100cm(ADJ)  
 W-20cm

NOTE - CLOTH CORD SET SUSPENSIONS ARE SUPPLIED IN A 1 METER DROP.



**3001192**  
**EMPIRE 8" OPAL MATT SINGLE CHAIN SUSP BROWN CORD BRASS B22**  
 H-100cm(ADJ)  
 W-20cm

NOTE - CHAIN SET SUSPENSIONS ARE SUPPLIED IN A 1 METER DROP.



**3001242**  
**EMPIRE 8" OPAL MATT ROD PND 1/2" BRASS B22**  
 H-100cm (ADJ)  
 W-20cm

NOTE - HALF METER 1/2" & 3/4" ROD & JOINER EXTENSIONS AVAILABLE



**3001278**  
**EMPIRE 14" OPAL MATT ROD PND 3/4" BRASS B22**  
 H-100cm (ADJ)  
 W-36cm



**3000043**  
**EMPIRE 8" OPAL MATT B/F BRASS B22**  
 H-27cm W-20cm



**3000011**  
**EMPIRE 14" OPAL MATT 3 CHAIN SUSP BRASS B22**  
 H-100cm(ADJ)  
 W-36cm

NOTE - 3 CHAIN SUSPENSION ARE SUPPLIED IN A 1 METER DROP WITH HOOKS



**3000017**  
**EMPIRE 14" OPAL MATT B/F BRASS B22**  
 H-25cm W-20cm

**Brass**

**Premier  
Range**

**NOTE -**  
HALF  
METER  
1/2" & 3/4"  
ROD  
&  
JOINER  
EXTENSIONS  
AVAILABLE

**3000280**

**PREMIER  
12"  
OPAL MATT  
ROD PND  
3/4"  
BRASS B22  
H-80cm(ADJ)  
W-30cm**

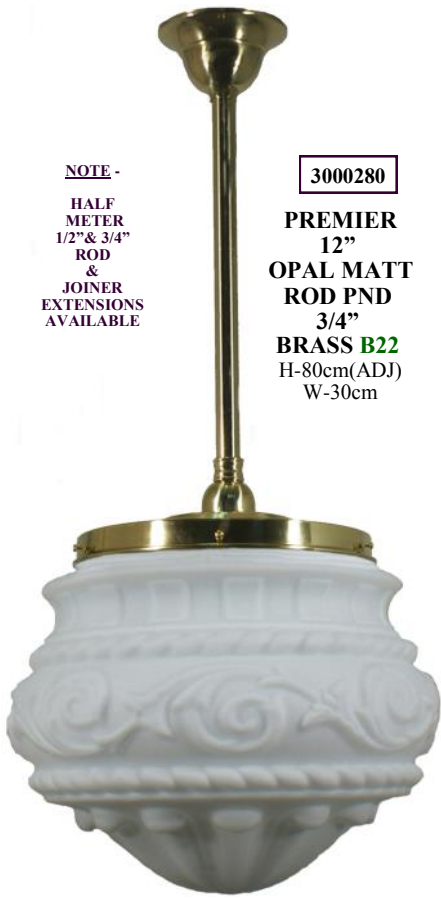

**NOTE -**  
CLOTH CORD  
SET  
SUSPENSIONS  
ARE  
SUPPLIED  
IN  
A  
1 METER  
DROP.

**3001113**

**PREMIER 8"  
OPAL MATT  
CLOTH  
BROWN  
CORD SUSP  
BRASS B22  
H-100cm(ADJ)  
W-23cm**



**3000256**

**PREMIER 8"  
OPAL MATT  
ROD PND  
1/2"  
BRASS B22  
H-75cm(ADJ)  
W-23cm**



**NOTE -**  
CHAIN  
SET  
SUSPENSIONS  
ARE  
SUPPLIED  
IN  
A  
1 METER  
DROP.

**3001193**

**PREMIER 8"  
OPAL MATT  
SINGLE  
CHAIN SUSP  
BROWN CORD  
BRASS B22  
H-100cm(ADJ)  
W-23cm**



**NOTE -**  
3 CHAIN  
SUSPENSION  
ARE  
SUPPLIED  
IN  
A  
1 METER  
DROP  
WITH  
HOOKS

**3000010**

**PREMIER 12"  
OPAL MATT  
3 CHAIN  
SUSP  
BRASS B22  
H-100cm(ADJ)  
W-30cm**

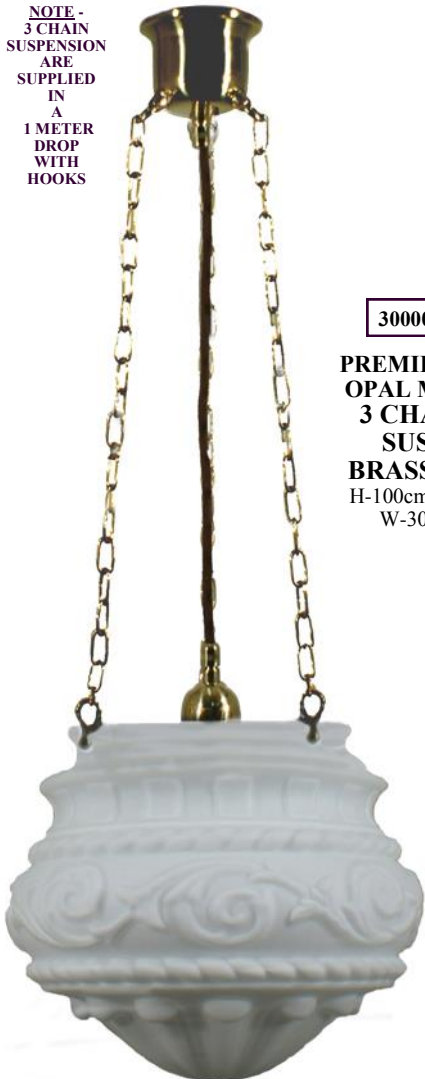

**3000045**

**PREMIER 8"  
OPAL MATT  
B/F BRASS B22  
H-23cm W-23cm**



**3000068**

**PREMIER 12"  
OPAL MATT  
B/F BRASS B22  
H-32cm W-30cm**



**Rod  
Set  
Range**

3000287

VICTORIAN 16" SCHOOLHOUSE  
OPAL GLOSS  
ROD PND  
3/4"  
BRASS B22  
H-85cm(ADJ)  
W-40cm

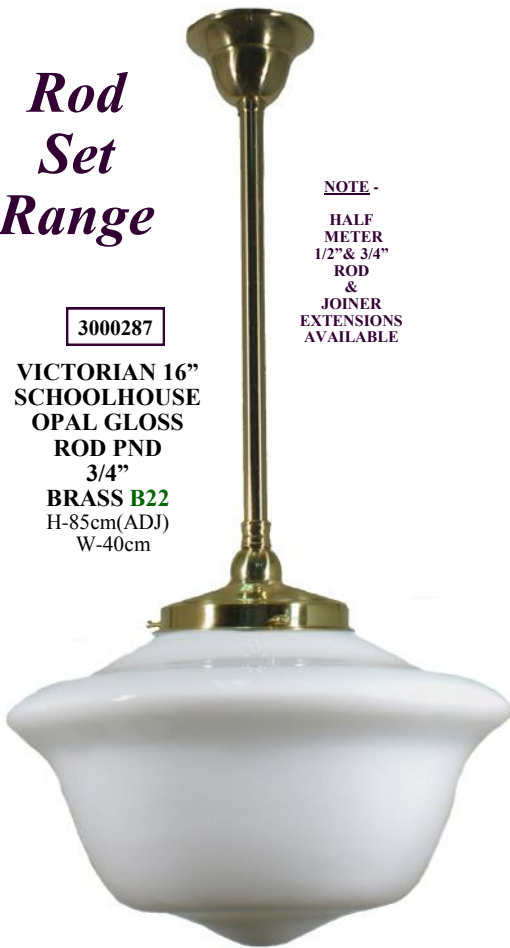

NOTE -  
HALF  
METER  
1/2" & 3/4"  
ROD  
&  
JOINER  
EXTENSIONS  
AVAILABLE

3000252

VICTORIAN 12" SCHOOLHOUSE  
OPAL GLOSS  
ROD PND  
1/2"  
BRASS B22  
H-75cm(ADJ)  
W-30cm



3000266

VICTORIAN 9" SCHOOLHOUSE  
OPAL GLOSS  
ROD PND  
1/2"  
BRASS B22  
H-70cm(ADJ)  
W-23cm



3000055

VICTORIAN 9" SCHOOLHOUSE  
OPAL GLOSS  
B/F  
BRASS B22  
H-19cm W-23cm



3000041

VICTORIAN 12" SCHOOLHOUSE  
OPAL GLOSS  
B/F  
BRASS B22  
H-23cm W-30cm



3000064

VICTORIAN 16" SCHOOLHOUSE OPAL GLOSS  
B/F BRASS B22  
H-30cm W-40cm



NOTE -

HALF  
METER  
1/2" & 3/4"  
ROD  
&  
JOINER  
EXTENSIONS  
AVAILABLE

3000289

LINCOLN SCHOOLHOUSE  
OPAL GLOSS  
ROD PND  
3/4"  
BRASS B22  
H-85cm (ADJ)  
W-36cm



**Brass**

3000066

LINCOLN SCHOOLHOUSE OPAL GLOSS  
B/F BRASS B22  
H-27cm W-36cm





# Rod Set Range

3000284

**DETROIT 14" OPAL GLOSS ROD PND 3/4" BRASS B22**  
H-78cm(ADJ) W-34cm



3000063

**DETROIT 14" OPAL GLOSS B/F BRASS B22**  
H-28cm W-34cm



3000042

**DETROIT 8" OPAL GLOSS B/F BRASS B22**  
H-24cm W-20cm



3000288

**BERGERAC OPAL MATT ROD PND 3/4" BRASS B22**  
H-94cm (ADJ) W-26cm



NOTE -

HALF METER 1/2" & 3/4" ROD & JOINER EXTENSIONS AVAILABLE

3000253

**DETROIT 8" OPAL GLOSS ROD PND 1/2" BRASS B22**  
H-72cm(ADJ) W-20cm

## Brass

3000273

**MOULINS OPAL GLOSS ROD PND 1/2" BRASS B22**  
H-70cm(ADJ) W-30cm



3000061

**MOULINS OPAL GLOSS B/F BRASS B22**  
H-21cm W-30cm



3000268

**CHATEAU OPAL GLOSS ROD PND 1/2" BRASS B22**  
H-70cm(ADJ) W-28cm



3000065

**CHATEAU OPAL GLOSS B/F BRASS B22**  
H-21cm W-30cm



**Rod  
Set  
Range**

3000283

**DERBY 13" OPAL MATT  
ROD PND  
3/4" BRASS B22**  
H-80cm(ADJ)  
W-33cm



3000062

**DERBY 13" OPAL MATT  
B/F BRASS B22**  
H-30cm W-33cm



3000053

**DERBY 9" OPAL MATT  
B/F BRASS B22**  
H-25cm W-23cm



3000267

**CANNES  
OPAL GLOSS  
ROD PND  
1/2" BRASS B22**  
H-70cm(ADJ)  
W-22cm



3000264

**DERBY 9" OPAL MATT  
ROD PND  
1/2" BRASS B22**  
H-75cm(ADJ) W-23cm



3000057

**CANNES  
OPAL GLOSS  
B/F BRASS B22**  
H-19cm W-22cm



**Brass**

**NOTE -**  
HALF  
METER  
1/2" & 3/4"  
ROD  
&  
JOINER  
EXTENSIONS  
AVAILABLE

3000058

**DOMEC  
OPAL GLOSS  
B/F BRASS B22**  
H-21cm W-20cm



3000034

**BEEHIVE 10"  
OPAL GLOSS  
B/F BRASS B22**  
H-22cm W-25cm



3000054

**PARKVILLE 9"  
OPAL GLOSS  
B/F BRASS B22**  
H-21cm W-23cm



3000270

**DOMEC  
OPAL GLOSS  
ROD PND  
1/2" BRASS B22**  
H-70cm(ADJ)  
W-20cm



3000243

**BEEHIVE 10"  
OPAL GLOSS  
ROD PND 1/2" BRASS B22**  
H-70cm (ADJ) W-25cm



3000265

**PARKVILLE 9"  
OPAL GLOSS  
ROD PND 1/2" BRASS B22**  
H-68cm(ADJ) W-23cm



# Rod Set Range



3000056

**CAMBRIDGE**  
B/F BRASS B22  
H - 38cm W - 22cm

3001279

**CAMBRIDGE**  
ROD PND  
3/4"  
BRASS B22  
H - 75cm (ADJ)  
W-22cm

**NOTE -**  
HALF  
METER  
1/2" & 3/4"  
ROD  
&  
JOINER  
EXTENSIONS  
AVAILABLE



## Brass

3000236

**CLAREDON 15"**  
ASTON PND  
3/4"  
BRASS E27  
H-70cm (ADJ)  
W-38cm

**NOTE -**

**CLAREDON**  
15"  
GLASS  
IS IN-BUILT  
DUE TO  
ITS  
WEIGHT

3000232

**CLAREDON 12"**  
ASTON PND  
3/4"  
BRASS E27  
H-65cm (ADJ)  
W-31cm



3000022

**CLAREDON 6"**  
B/F BRASS B22  
H-20cm W-15cm



# Metal Shade Range

3000132

EDWARDIAN 390mm WHITE

ROD PND 1/2" BRASS B22



NOTE - HALF METER 1/2" & 3/4" ROD & JOINER EXTENSIONS AVAILABLE

3000126

EDWARDIAN 390mm WHITE B/F BRASS B22



3000123

EDWARDIAN 250mm WHITE B/F BRASS B22



NOTE - HALF METER 1/2" & 3/4" ROD & JOINER EXTENSIONS AVAILABLE

3000131

EDWARDIAN 390mm WHITE

CLOTH BROWN CORD SUSP BRASS B22



# Brass

3000185

EDWARDIAN 250mm WHITE LUKE 1/LT W/B BRASS B22

H - 25cm W - 25cm P - 32cm



# Edwardian Range

NOTE - CLOTH CORD SET SUSPENSIONS ARE SUPPLIED IN A 1 METER DROP.

3000127

EDWARDIAN 390mm BLACK

CLOTH BROWN CORD SUSP BRASS B22



3000128

EDWARDIAN 390mm BLACK

ROD PND 1/2" BRASS B22



NOTE - HALF METER 1/2" & 3/4" ROD & JOINER EXTENSIONS AVAILABLE

3000124

EDWARDIAN 390mm BLACK B/F BRASS B22



3000121

EDWARDIAN 250mm BLACK B/F BRASS B22



3000183

EDWARDIAN 250mm BLACK LUKE 1/LT W/B BRASS B22

H - 25cm W - 25cm P - 32cm



\* NOTE \* ALL METAL SHADES ARE POWDER COATED COLOURS WITH A WHITE INNER

**Brass**

**Metal Shade Range**

NOTE -  
HALF  
METER  
1/2" & 3/4"  
ROD  
&  
JOINER  
EXTENSIONS  
AVAILABLE

3000277  
WAREHOUSE  
300mm  
WHITE  
-  
ROD PND  
1/2"  
BRASS  
B22

3000107  
WAREHOUSE  
300mm  
WHITE  
-  
CLOTH  
BROWN  
CORD SUSP  
BRASS  
B22

NOTE -  
CLOTH CORD  
SET  
SUSPENSIONS  
ARE  
SUPPLIED  
IN  
A  
1 METER  
DROP.

3000110  
WAREHOUSE  
420mm WHITE  
-  
CLOTH BROWN  
CORD SUSP  
BRASS B22

3000292  
WAREHOUSE  
420mm WHITE  
-  
ROD PND 3/4 "  
BRASS  
B22



3000331  
WAREHOUSE 300mm  
WHITE B/F BRASS B22

\* NOTE \*  
ALL METAL  
SHADES ARE  
POWDER COATED  
COLOURS WITH A  
WHITE INNER

**Warehouse Range**

NOTE -  
HALF  
METER  
1/2" & 3/4"  
ROD  
&  
JOINER  
EXTENSIONS  
AVAILABLE

3000275  
WAREHOUSE  
300mm  
BLACK  
-  
ROD PND  
1/2"  
BRASS  
B22

3000105  
WAREHOUSE  
300mm  
BLACK  
-  
CLOTH  
BROWN  
CORD SUSP  
BRASS  
B22

NOTE -  
CLOTH CORD  
SET  
SUSPENSIONS  
ARE  
SUPPLIED  
IN  
A  
1 METER  
DROP.

3000108  
WAREHOUSE  
420mm BLACK  
-  
CLOTH BROWN  
CORD SUSP  
BRASS B22

3000290  
WAREHOUSE  
420mm BLACK  
-  
ROD PND 3/4 "  
BRASS  
B22



3000329  
WAREHOUSE 300mm  
BLACK B/F BRASS B22

# Accessories In Chrome



3016021

2 1/4" GALLERY  
CHROME-29mm HOLE



3016022

3 1/4" GALLERY  
CHROME-29mm HOLE



3016023

4 1/4" GALLERY  
CHROME-29mm HOLE



3016024

6 1/4" GALLERY  
CHROME-29mm HOLE



3016025

8 1/4" GALLERY  
CHROME-29mm HOLE



3016020

12 1/4" GALLERY  
CHROME-29mm HOLE



3016002

ANGLE CANOPY  
CHROME  
H-80mm W-100mm

## Chrome



3016015

FAN KIT CHROME B22  
TO SUIT  
2 1/4" - 3 1/4" - 4 1/4" - 6 1/4"  
8 1/4" - 12 1/4" GALLERY



3016005

BATTEN COVER  
CHROME  
29mm HOLE



3006022

CEILING  
HOOK 1/2"



3006023

CEILING  
HOOK 3/4"



3016034

ROD SET  
1/2" x 1/2MT  
CHROME B22



3016036

ROD SET  
3/4" x 1/2MT  
CHROME B22



3016030

ASTON ROD SET  
1/2" x 1/2MT  
CHROME E27



3016032

ASTON ROD SET  
3/4" x 1/2MT  
CHROME E27



3016026

ROD  
& JOINER  
1/2" x 1/2MT  
CHROME



3016028

ROD  
& JOINER  
3/4" x 1/2MT  
CHROME

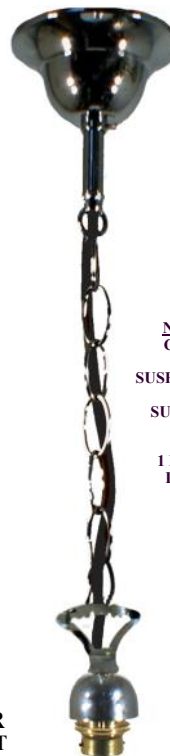

3016006

CHAIN  
BLACK CORD  
SUSP 1 MT  
CHROME B22

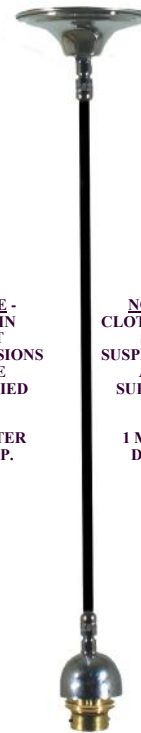

3016010

CLOTH  
BLACK CORD  
SUSP 1 MT  
CHROME B22



3016001

3 CHAIN SUSP  
BLACK CORD  
W-HOOKS 1 MT  
CHROME B22

NOTE -  
CHAIN  
SET  
SUSPENSIONS  
ARE  
SUPPLIED  
IN  
A  
1 METER  
DROP.

NOTE -  
CLOTH CORD  
SET  
SUSPENSIONS  
ARE  
SUPPLIED  
IN  
A  
1 METER  
DROP.

*Wall  
Bracket  
Range*

*Chrome*



3010213

7011  
WALL SCONCE  
CHROME **B22**  
H-33cm W-15cm  
P-10cm



3010116

LOXTON 1/LT W/B  
DECATRON OPAL MATT  
CHROME **B22**  
H - 22cm W - 12cm P - 21cm



3010219

WAUBRA 1/LT W/B CHROME  
CONO OPAL MATT **B22**  
H-20cm W-14cm P-19cm



3010218

WAUBRA 1/LT W/B CHROME  
CONO CLEAR **B22**  
H-20cm W-14cm P-19cm



3010107

KOSCINA 1/LT W/B CHROME  
CONO OPAL MATT **B22**  
H-20cm W-14cm P-16cm



3010106

KOSCINA 1/LT W/B CHROME  
CONO CLEAR **B22**  
H-20cm W-14cm P-16cm



3010217

WAUBRA 1/LT W/B CHROME  
DECATRON OPAL MATT **B22**  
H - 19cm W - 12cm P - 18cm



3010108

KOSCINA 1/LT W/B CHROME  
DECATRON OPAL MATT **B22**  
H-19cm W-12cm P-16cm



3010091

KLINE 1/LT W/B CHROME  
ZIPPER 23 FROST **E27**  
H-22cm W-12cm P-16cm



3010090

KLINE 1/LT W/B CHROME  
ZIPPER 23 CLEAR **E27**  
H-22cm W-12cm P-16cm



3010110

LOXTON 1/LT W/B CHROME  
CONO CLEAR **B22**  
H - 22cm W - 14cm P - 22cm



3010111

LOXTON 1/LT W/B CHROME  
CONO OPAL MATT **B22**  
H - 22cm W - 14cm P - 22cm

# ST Kilda Range

# Chrome

**NOTE -**  
HALF  
METER  
1/2" & 3/4"  
ROD  
&  
JOINER  
EXTENSIONS  
AVAILABLE

**3010078**

**ST KILDA 8" OPAL MATT CLOTH BLACK CORD SUSP CHROME B22**  
H-100cm(ADJ)  
W-21cm

**NOTE -**  
CLOTH CORD  
SET  
SUSPENSIONS  
ARE  
SUPPLIED  
IN  
A  
1 METER  
DROP.

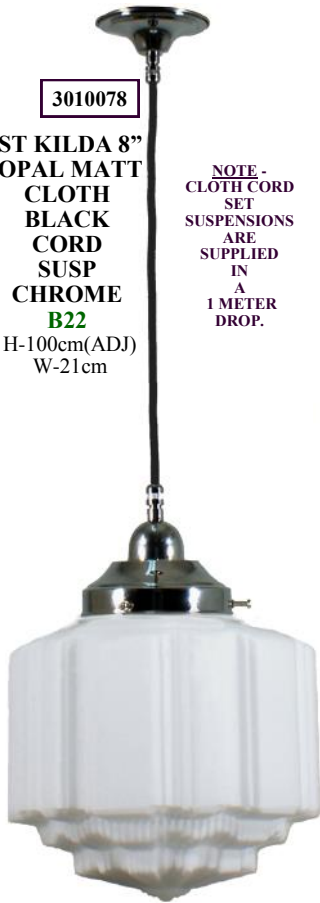

**NOTE -**  
CHAIN  
SET  
SUSPENSIONS  
ARE  
SUPPLIED  
IN  
A  
1 METER  
DROP.

**3010072**

**ST KILDA 8" OPAL MATT SINGLE CHAIN BLACK CORD SUSP CHROME B22**  
H-100cm(ADJ)  
W-21cm



**3010185**

**ST KILDA 8" OPAL MATT ROD PND 1/2" CHROME B22**  
H-73cm(ADJ)  
W-21cm



**3010199**

**ST KILDA 14" OPAL MATT ROD PND 3/4" CHROME B22**  
H-75cm(ADJ)  
W-36cm



**3010037**

**ST KILDA 8" OPAL MATT B/F CHROME B22**  
H-22cm W-21cm



**3010007**

**ST KILDA 14" OPAL MATT 3 CHAIN BLACK CORD SUSP CHROME B22**  
H-100cm (ADJ)  
W-34cm

**NOTE -**  
3 CHAIN  
SUSPENSION  
ARE  
SUPPLIED  
IN  
A  
1 METER  
DROP  
WITH  
HOOKS



**3010014**

**ST KILDA 14" OPAL MATT B/F CHROME B22**  
H-29cm W-36cm





# Senator Range

3010220

**SENATOR 17"**  
**OPAL MATT**  
**3 CHAIN**  
**BLACK CORD**  
**SUSP**  
**CHROME B22**  
 H-100cm (ADJ)  
 W-42cm

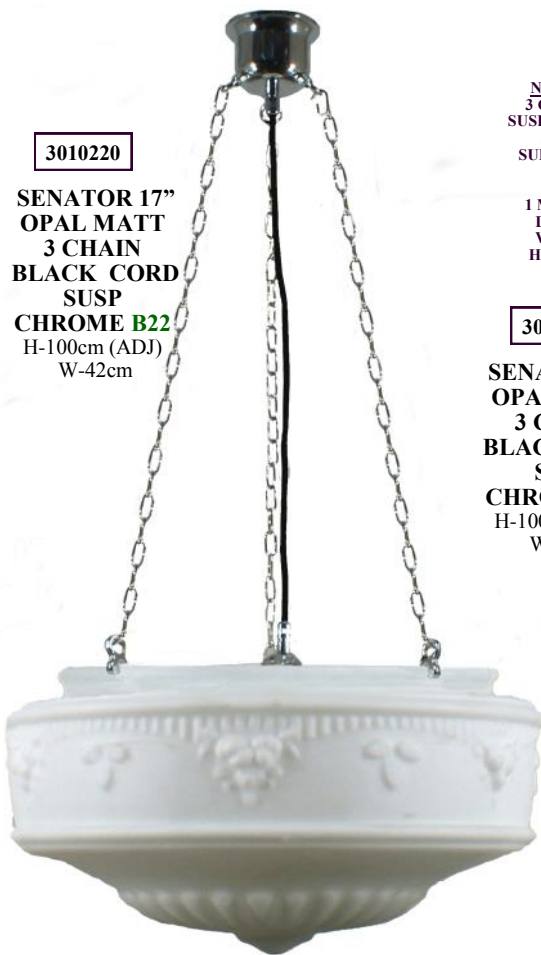

NOTE -  
 3 CHAIN  
 SUSPENSION  
 ARE  
 SUPPLIED  
 IN  
 A  
 1 METER  
 DROP  
 WITH  
 HOOKS

3010006

**SENATOR 14"**  
**OPAL MATT**  
**3 CHAIN**  
**BLACK CORD**  
**SUSP**  
**CHROME B22**  
 H-100cm (ADJ)  
 W-34cm



3010004

**SENATOR 11"**  
**OPAL MATT**  
**3 CHAIN**  
**BLACK CORD**  
**SUSP**  
**CHROME B22**  
 H-100cm (ADJ)  
 W-28cm



## Chrome

NOTE -  
 CLOTH CORD  
 SET  
 SUSPENSIONS  
 ARE  
 SUPPLIED  
 IN  
 A  
 1 METER  
 DROP.

3010181

**SENATOR 8"**  
**OPAL MATT**  
**ROD PND**  
**1/2"**  
**CHROME**  
**B22**  
 H-75cm (ADJ)  
 W-20cm



3010222

**SENATOR 8"**  
**OPAL MATT**  
**CLOTH**  
**BLACK CORD**  
**SUSP**  
**CHROME B22**  
 H-100cm(ADJ)  
 W-20cm



3010015

**SENATOR 14"OPAL MATT**  
**B/F CHROME B22**  
 H-32cm W-36cm



NOTE -  
 HALF  
 METER  
 1/2" & 3/4"  
 ROD  
 &  
 JOINER  
 EXTENSIONS  
 AVAILABLE

3010198

**SENATOR 14"**  
**OPAL MATT**  
**ROD PND**  
**3/4"**  
**CHROME B22**  
 H-75cm(ADJ)  
 W-36cm



3010172

**SENATOR 11"**  
**OPAL MATT**  
**ROD PND**  
**1/2"**  
**CHROME B22**  
 H-70cm(ADJ)  
 W-28cm



NOTE -  
 CHAIN  
 SET  
 SUSPENSIONS  
 ARE  
 SUPPLIED  
 IN  
 A  
 1 METER  
 DROP.

3010221

**SENATOR 8"**  
**OPAL MATT**  
**SINGLE**  
**CHAIN**  
**BLACK**  
**CORD**  
**SUSP**  
**CHROME**  
**B22**  
 H-100cm(ADJ)  
 W-20cm

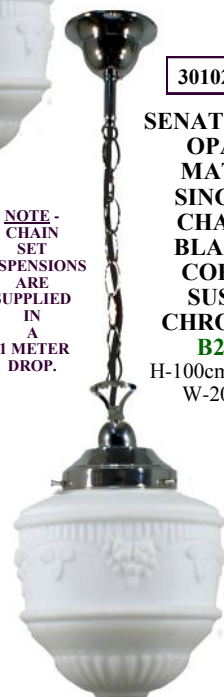

3010047

**SENATOR 11" OPAL MATT**  
**B/F CHROME B22**  
 H-28cm W-28cm



3010034

**SENATOR 8" OPAL MATT**  
**B/F CHROME B22**  
 H-23cm W-20cm



# Empire Range

# Chrome

NOTE - CLOTH CORD SET SUSPENSIONS ARE SUPPLIED IN A 1 METER DROP.



3010224

EMPIRE 8" OPAL MATT CLOTH CORD SUSP CHROME B22  
H-100cm(ADJ)  
W-20cm

NOTE - CHAIN SET SUSPENSIONS ARE SUPPLIED IN A 1 METER DROP.



3010223

EMPIRE 8" OPAL MATT SINGLE CHAIN BLACK CORD SUSP CHROME B22  
H-100cm(ADJ)  
W-20cm

NOTE - HALF METER 1/2" & 3/4" ROD & JOINER EXTENSIONS AVAILABLE



3010180

EMPIRE 8" OPAL MATT ROD PND 1/2" CHROME B22  
H-100cm (ADJ)  
W-20cm



3010197

EMPIRE 14" OPAL MATT ROD PND 3/4" CHROME B22  
H-100cm (ADJ)  
W-36cm

NOTE - 3 CHAIN SUSPENSION ARE SUPPLIED IN A 1 METER DROP WITH HOOKS

3010032  
EMPIRE 8" OPAL MATT B/F CHROME B22  
H-27cm W-20cm



3010005  
EMPIRE 14" OPAL MATT 3 CHAIN BLACK CORD SUSP CHROME B22  
H-100cm(ADJ)  
W-36cm



3010013  
EMPIRE 14" OPAL MATT B/F CHROME B22  
H-25cm W-20cm



## Chrome

## Premier Range

**NOTE -**  
HALF  
METER  
1/2" & 3/4"  
ROD  
&  
JOINER  
EXTENSIONS  
AVAILABLE

3010227

**PREMIER 12"**  
**OPAL MATT**  
**ROD PND**  
**3/4"**  
**CHROME B22**  
H-80cm(ADJ)  
W-30cm



**NOTE -**  
CLOTH CORD  
SET  
SUSPENSIONS  
ARE  
SUPPLIED  
IN  
A  
1 METER  
DROP.

3010230

**PREMIER 8"**  
**OPAL MATT**  
**CLOTH**  
**BLACK**  
**CORD**  
**SUSP**  
**CHROME B22**  
H-100cm(ADJ)  
W-23cm



3010228

**PREMIER 8"**  
**OPAL MATT**  
**ROD PND**  
**1/2"**  
**CHROME B22**  
H-75cm(ADJ)  
W-23cm



3010231

**PREMIER 8"**  
**OPAL MATT**  
**SINGLE**  
**CHAIN**  
**BLACK**  
**CORD**  
**SUSP**  
**CHROME B22**  
H-100cm(ADJ)  
W-23cm



**NOTE -**  
CHAIN  
SET  
SUSPENSIONS  
ARE  
SUPPLIED  
IN  
A  
1 METER  
DROP.

**NOTE -**  
3 CHAIN  
SUSPENSION  
ARE  
SUPPLIED  
IN  
A  
1 METER  
DROP  
WITH  
HOOKS

3010225

**PREMIER 12"**  
**OPAL MATT**  
**3 CHAIN**  
**BLACK CORD**  
**SUSP**  
**CHROME B22**  
H-100cm(ADJ)  
W-30cm

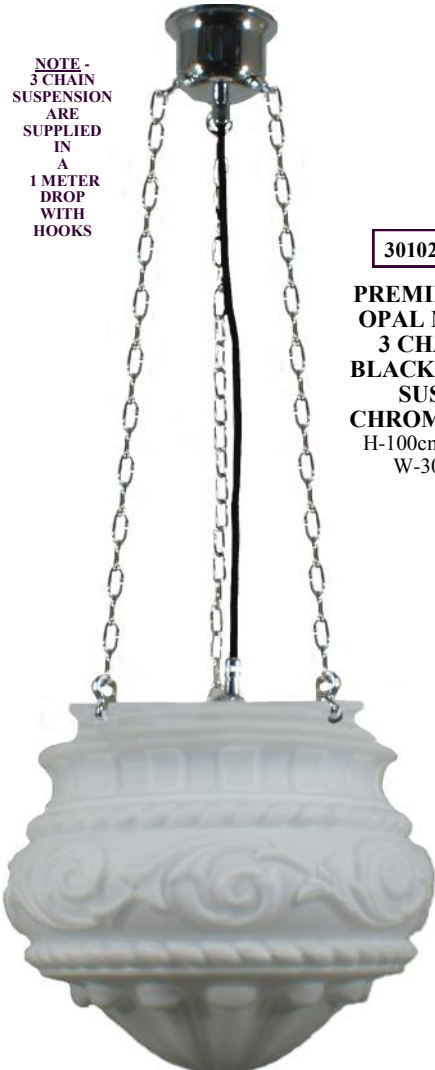

3010229

**PREMIER 8"**  
**OPAL MATT**  
**B/F CHROME B22**  
H-23cm W-23cm



3010226

**PREMIER 12"**  
**OPAL MATT**  
**B/F CHROME B22**  
H-32cm W-30cm



# Rod Set Range

3010200

VICTORIAN 16" SCHOOLHOUSE OPAL GLOSS ROD PND 3/4" CHROME B22 H-85cm(ADJ) W-40cm

NOTE -  
HALF METER 1/2" & 3/4" ROD & JOINER EXTENSIONS AVAILABLE

3010177

VICTORIAN 12" SCHOOLHOUSE OPAL GLOSS ROD PND 1/2" CHROME B22 H-75cm(ADJ) W-30cm

3010189

VICTORIAN 9" SCHOOLHOUSE OPAL GLOSS ROD PND 1/2" CHROME B22 H-70cm(ADJ) W-23cm

3010041

VICTORIAN 9" SCHOOLHOUSE OPAL GLOSS B/F CHROME B22 H-19cm W-23cm

3010028

VICTORIAN 12" SCHOOLHOUSE OPAL GLOSS B/F CHROME B22 H-23cm W-30cm

3010232

VICTORIAN 16" SCHOOLHOUSE OPAL GLOSS B/F CHROME B22 H-30cm W-40cm

3010202

LINCOLN SCHOOLHOUSE OPAL GLOSS ROD PND 3/4" CHROME B22 H-85cm (ADJ) W-36cm

NOTE -  
HALF METER 1/2" & 3/4" ROD & JOINER EXTENSIONS AVAILABLE

3010046

LINCOLN SCHOOLHOUSE OPAL GLOSS B/F CHROME B22 H-27cm W-36cm

## Chrome

*Rod Set  
Range*

*Chrome*

3010201

**BERGERAC  
OPAL MATT  
ROD PND  
3/4"**  
**CHROME B22**  
H-94cm (ADJ)  
W-26cm

**NOTE -**  
HALF  
METER  
1/2" & 3/4"  
ROD  
&  
JOINER  
EXTENSIONS  
AVAILABLE

3010044

**DETROIT 14"**  
**OPAL GLOSS  
B/F CHROME B22**  
H-28cm W-34cm



3010179

**DETROIT 8"**  
**OPAL GLOSS  
ROD PND  
1/2"**  
**CHROME B22**  
H-72cm(ADJ)  
W-20cm



3010030

**DETROIT 8"**  
**OPAL GLOSS  
B/F CHROME B22**  
H-24cm W-20cm



3010196

**DETROIT 14"**  
**OPAL GLOSS  
ROD PND  
3/4"**  
**CHROME B22**  
H-78cm(ADJ)  
W-34cm



3010193

**MOULINS  
OPAL GLOSS  
ROD PND  
1/2"**  
**CHROME B22**  
H-70cm(ADJ)  
W-30cm



3010042

**MOULINS  
OPAL GLOSS  
B/F CHROME B22**  
H-21cm W-30cm



3010191

**CHATEAU  
OPAL GLOSS  
ROD PND  
1/2"**  
**CHROME B22**  
H-70cm(ADJ)  
W-30cm



3010045

**CHATEAU  
OPAL GLOSS  
B/F CHROME B22**  
H-21cm W-30cm



# Rod Set Range

**3010188**  
**DERBY 9"**  
**OPAL MATT**  
**ROD PND**  
**1/2"**  
**CHROME**  
**B22**  
 H-75cm(ADJ) W-23cm



**3010039**  
**DERBY 9"**  
**OPAL MATT**  
**B/F CHROME**  
**B22**  
 H-25cm W-23cm



**3010195**  
**DERBY 13"**  
**OPAL MATT**  
**ROD PND**  
**3/4"**  
**CHROME**  
**B22**  
 H-80cm(ADJ) W-33cm



**3010043**  
**DERBY 13"**  
**OPAL MATT**  
**B/F CHROME**  
**B22**  
 H-30cm W-33cm



**3010190**  
**CANNES**  
**OPAL GLOSS**  
**ROD PND**  
**1/2"**  
**CHROME**  
**B22**  
 H-70cm(ADJ) W-22cm



**3010029**  
**CANNES**  
**OPAL GLOSS**  
**B/F CHROME**  
**B22**  
 H-19cm W-22cm

## Chrome

**NOTE -**  
 HALF  
 METER  
 1/2" & 3/4"  
 ROD  
 &  
 JOINER  
 EXTENSIONS  
 AVAILABLE

**3010031**  
**DOMEC**  
**OPAL GLOSS**  
**B/F CHROME**  
**B22**  
 H-21cm W-20cm



**3010026**  
**BEEHIVE 10"**  
**OPAL GLOSS**  
**B/F CHROME**  
**B22**  
 H-22cm W-25cm



**3010040**  
**PARKVILLE 9"**  
**OPAL GLOSS**  
**B/F CHROME**  
**B22**  
 H-21cm W-23cm



**3010192**  
**DOMEC OPAL GLOSS**  
**ROD PND 1/2" CHROME**  
**B22**  
 H-70cm(ADJ) W-20cm



**3010171**  
**BEEHIVE 10" OPAL GLOSS**  
**ROD PND 1/2" CHROME**  
**B22**  
 H-70cm (ADJ) W-25cm

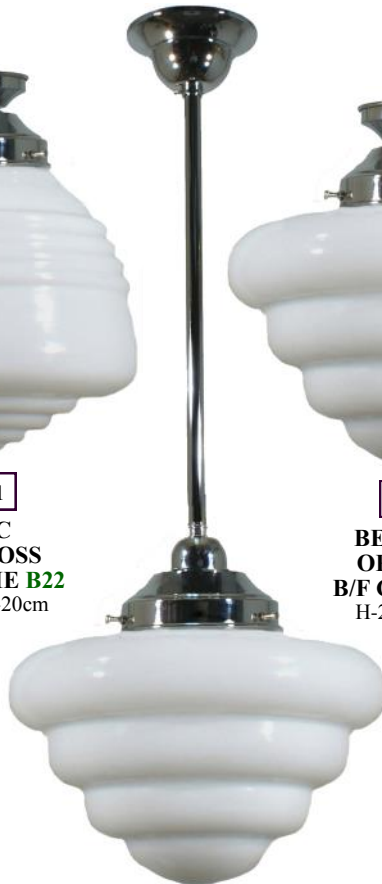

**3010233**  
**PARKVILLE 9"**  
**OPAL GLOSS**  
**ROD PND 1/2" CHROME**  
**B22**  
 H-68cm(ADJ) W-23cm



# Sphere Range



**3010234**  
**SPHERE**  
**12" OPAL GLOSS B/F CHROME**  
**B22**  
 H-34cm  
 W-30cm



**3010027**  
**SPHERE**  
**10" OPAL GLOSS B/F CHROME**  
**B22**  
 H-28cm  
 W-25cm



**3010033**  
**SPHERE**  
**8" OPAL GLOSS B/F CHROME**  
**B22**  
 H-22cm  
 W-20cm



**3010024**  
**SPHERE 6" OPAL GLOSS B/F CHROME**  
**B22**  
 H-17cm W-15cm

**NOTE -**  
 HALF METER  
 1/2" & 3/4"  
 ROD  
 &  
 JOINER  
 EXTENSIONS  
 AVAILABLE



**3010194**  
**SPHERE 12" OPAL GLOSS ROD PND 3/4" CHROME**  
**B22**  
 H-86cm (ADJ)  
 W-30cm

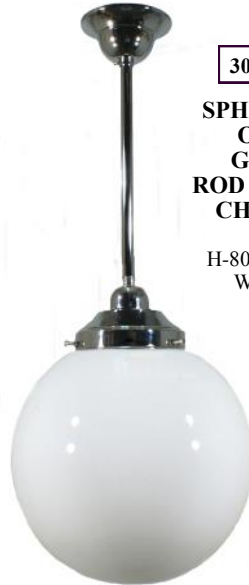

**3010170**  
**SPHERE 10" OPAL GLOSS ROD PND 1/2" CHROME**  
**B22**  
 H-80cm (ADJ)  
 W-25cm



**3010178**  
**SPHERE 8" OPAL GLOSS ROD PND 1/2" CHROME**  
**B22**  
 H-74cm (ADJ)  
 W-20cm

**NOTE -**  
 CHAIN SET  
 SUSPENSIONS  
 ARE  
 SUPPLIED  
 IN  
 A  
 1 METER  
 DROP.

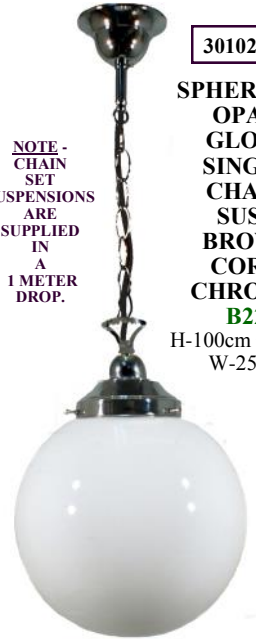

**3010235**  
**SPHERE 10" OPAL GLOSS SINGLE CHAIN SUSP BROWN CORD CHROME**  
**B22**  
 H-100cm +(ADJ)  
 W-25cm



**3010237**  
**SHEFFIELD**  
**12" B/F CHROME**  
**B22**  
 H-34cm  
 W-30cm



**3010239**  
**SHEFFIELD**  
**10" B/F CHROME**  
**B22**  
 H-28cm  
 W-25cm



**3010241**  
**SHEFFIELD**  
**8" B/F CHROME**  
**B22**  
 H-22cm  
 W-20cm



**3010243**  
**SHEFFIELD 6" B/F CHROME**  
**B22**  
 H-17cm W-15cm

**NOTE -**  
 HALF METER  
 1/2" & 3/4"  
 ROD  
 &  
 JOINER  
 EXTENSIONS  
 AVAILABLE



**3010236**  
**SHEFFIELD 12" ROD PND 3/4" CHROME**  
**B22**  
 H-86cm (ADJ)  
 W-30cm



**3010238**  
**SHEFFIELD 10" ROD PND 1/2" CHROME**  
**B22**  
 H-80cm (ADJ)  
 W-25cm



**3010240**  
**SHEFFIELD 8" ROD PND 1/2" CHROME**  
**B22**  
 H-74cm (ADJ)  
 W-20cm

**NOTE -**  
 CHAIN SET  
 SUSPENSIONS  
 ARE  
 SUPPLIED  
 IN  
 A  
 1 METER  
 DROP.



**3010242**  
**SHEFFIELD 10" SINGLE CHAIN SUSP BROWN CORD CHROME**  
**B22**  
 H-100cm +(ADJ)  
 W-25cm

## Chrome

# Paramount Range

## Chrome

1000705

**PARAMOUNT LINCOLN SCHOOLHOUSE**  
1/LT PND  
**CLEAR FLEX CHROME E27**  
FRAME SIZE  
WITH OUT CHAIN-  
1MT CHAIN SUPPLIED  
H-44cm(ADJ)  
W-36cm

1000703

**PARAMOUNT VICTORIAN 12" SCHOOLHOUSE**  
1/LT PND  
**CLEAR FLEX CHROME E27**  
FRAME SIZE  
WITH OUT CHAIN-  
1MT CHAIN SUPPLIED  
H-41cm(ADJ)  
W-30cm

1000702

**PARAMOUNT VICTORIAN 9" SCHOOLHOUSE**  
1/LT PND  
**CLEAR FLEX CHROME E27**  
FRAME SIZE  
WITH OUT CHAIN-  
1MT CHAIN SUPPLIED  
H-34cm(ADJ)  
W-23cm

1000704

**PARAMOUNT VICTORIAN 16" SCHOOLHOUSE**  
1/LT PND  
**CLEAR FLEX CHROME E27**  
FRAME SIZE  
WITH OUT CHAIN-  
1MT CHAIN SUPPLIED  
H-45cm(ADJ)  
W-40cm

1000387

**PARAMOUNT CHATEAU**  
1/LT PND  
**CLEAR FLEX CHROME E27**  
FRAME SIZE  
WITH OUT CHAIN-  
1MT CHAIN SUPPLIED  
H-36cm(ADJ) W-30cm

1000390

**PARAMOUNT BEEHIVE 10"**  
1/LT PND  
**CLEAR FLEX CHROME E27**  
FRAME SIZE  
WITH OUT CHAIN-  
1MT CHAIN SUPPLIED  
H-37cm(ADJ)  
W-26cm

1000391

**PARAMOUNT DOME**  
1/LT PND  
**CLEAR FLEX CHROME E27**  
FRAME SIZE  
WITH OUT CHAIN-  
1MT CHAIN SUPPLIED  
H-37cm(ADJ)  
W-20cm

1000393

**PARAMOUNT DETROIT 14" OPAL GLOSS**  
1/LT PND  
**CLEAR FLEX CHROME E27**  
FRAME SIZE  
WITH OUT CHAIN-  
1MT CHAIN SUPPLIED  
H-42cm(ADJ)  
W-35cm

1000700

**PARAMOUNT MOULINS**  
1/LT PND  
**CLEAR FLEX CHROME E27**  
FRAME SIZE  
WITH OUT CHAIN-  
1MT CHAIN SUPPLIED  
H-37cm(ADJ)  
W-30cm



# Paramount Range

1000714

PARAMOUNT  
SPHERE 12" OPAL GLOSS  
1/LT PND  
CLEAR FLEX  
CHROME E27  
FRAME SIZE  
WITH OUT CHAIN-  
1MT CHAIN SUPPLIED  
H-86cm (ADJ)  
W-30cm



1000713

PARAMOUNT  
SPHERE 10" OPAL GLOSS  
1/LT PND  
CLEAR FLEX  
CHROME E27  
FRAME SIZE  
WITH OUT CHAIN-  
1MT CHAIN SUPPLIED  
H-80cm (ADJ)  
W-25cm



1000712

PARAMOUNT  
SPHERE 8" OPAL GLOSS  
1/LT PND  
CLEAR FLEX  
CHROME E27  
FRAME SIZE  
WITH OUT CHAIN-  
1MT CHAIN SUPPLIED  
H-74cm (ADJ)  
W-20cm



1000711

PARAMOUNT  
PARKVILLE 9" OPAL GLOSS  
1/LT PND  
CLEAR FLEX  
CHROME E27  
FRAME SIZE  
WITH OUT CHAIN-  
1MT CHAIN SUPPLIED  
H-68cm (ADJ)  
W-23cm



Chrome

1000715

PARAMOUNT  
ST KILDA 8" OPAL MATT  
1/LT PND  
CLEAR FLEX  
CHROME E27  
FRAME SIZE  
WITH OUT CHAIN-  
1MT CHAIN SUPPLIED  
H-73cm (ADJ)  
W-21cm



1000716

PARAMOUNT  
ST KILDA 14" OPAL MATT  
1/LT PND  
CLEAR FLEX  
CHROME E27  
FRAME SIZE  
WITH OUT CHAIN-  
1MT CHAIN SUPPLIED  
H-75cm (ADJ)  
W-36cm



1000710

PARAMOUNT  
DERBY 13" OPAL MATT  
1/LT PND  
CLEAR FLEX  
CHROME E27  
FRAME SIZE  
WITH OUT CHAIN-  
1MT CHAIN SUPPLIED  
H-80cm (ADJ)  
W-30cm



# Claredon Range

1000452

CLAREDON  
12"  
ASTON PND  
3/4"  
CHROME  
E27  
H-65cm (ADJ)  
W-31cm

NOTE -  
HALF  
METER  
1/2" & 3/4"  
ROD  
&  
JOINER  
EXTENSIONS  
AVAILABLE

## Chrome

1000456

CLAREDON  
15"  
ASTON PND  
3/4"  
CHROME  
E27  
H-70cm (ADJ)  
W-38cm

1000683

PARAMOUNT  
CLAREDON  
12"  
1/LT PND  
CLEAR FLEX  
CHROME  
E27  
FRAME SIZE  
WITH OUT CHAIN  
1MT CHAIN SUPPLIED  
H-34cm(ADJ)  
W-30cm

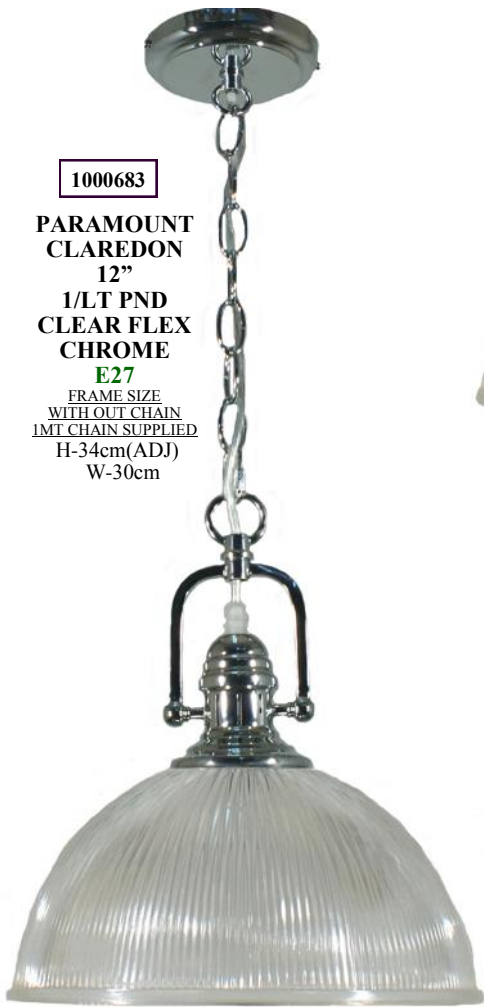

1000688

PARAMOUNT  
CLAREDON  
15"  
1/LT PND  
CLEAR FLEX  
CHROME  
E27  
FRAME SIZE  
WITH OUT CHAIN  
1MT CHAIN SUPPLIED  
H-38cm(ADJ)  
W-37cm



3010018

CLAREDON 6"  
B/F CHROME B22  
H-20cm W-15cm



# Accessories In Patina Black



3026022

2 1/4" GALLERY  
PATINA BLK-29mm HOLE



3026023

3 1/4" GALLERY  
PATINA BLK-29mm HOLE



3026024

4 1/4" GALLERY  
PATINA BLK-29mm HOLE



3026025

6 1/4" GALLERY  
PATINA BLK-29mm



3026026

8 1/4" GALLERY  
PATINA BLK-29mm HOLE



3026021

12 1/4" GALLERY  
PATINA BLK-29mm HOLE



3026002

ANGLE CANOPY  
PATINA BLK  
H-80mm W-100mm



3026041

FAN KIT PATINA BLK B22  
TO SUIT  
2 1/4"- 3 1/4"- 4 1/4"- 6 1/4"  
8 1/4"- 12 1/4" GALLERY



3026004

BATTEN COVER  
PATINA BLK-29mm HOLE

## Patina Black



3006022

CEILING  
HOOK 1/2"



3006023

CEILING  
HOOK 3/4"



3026037

ROD SET  
1/2" x 1/2MT  
PATINA BLK  
B22



3026039

ROD SET  
3/4" x 1/2MT  
PATINA BLK  
B22



3026032

ROD  
& JOINER  
3/4" x 1/2MT  
PATINA BLK



3026031

ROD  
& JOINER  
1/2" x 1/2MT  
PATINA BLK



3026036

ASTON ROD SET  
3/4" x 1/2MT  
PATINA BLK  
E27



3026032

ROD  
& JOINER  
3/4" x 1/2MT  
PATINA BLK



3026005

CHAIN  
BLACK CORD  
SUSP 1 MT  
PATINA BLK  
B22



3026009

CLOTH  
BLACK CORD  
SUSP 1 MT  
PATINA BLK  
B22



3026001

3 CHAIN SUSP  
BLACK CORD  
W-HOOKS 1 MT  
PATINA BLK  
B22

# ST Kilda Range

3020057

ST KILDA 8"  
OPAL MATT  
SINGLE  
CHAIN  
BLACK  
CORD SUSP  
PATINA BLK

**B22**  
H-100cm(ADJ)  
W-21cm

**NOTE -**  
CHAIN  
SET  
SUSPENSIONS  
ARE  
SUPPLIED  
IN  
A  
1 METER  
DROP.



**NOTE -**  
HALF  
METER  
1/2" & 3/4"  
ROD  
&  
JOINER  
EXTENSIONS  
AVAILABLE

3020113

ST KILDA 14"  
OPAL MATT  
ROD PND 3/4"  
PATINA BLK

**B22**  
H-75cm(ADJ)  
W-36cm



3020122

ST KILDA 8"  
OPAL MATT  
ROD PND 1/2"  
PATINA BLK

**B22**  
H-73cm(ADJ)  
W-21cm



3020067

ST KILDA 8"  
OPAL MATT  
CLOTH  
BLACK  
CORD SUSP  
PATINA BLK

**B22**  
H-100cm(ADJ)  
W-21cm

**NOTE -**  
CLOTH CORD  
SET  
SUSPENSIONS  
ARE  
SUPPLIED  
IN  
A  
1 METER  
DROP.



*Patina  
Black*

3020032

ST KILDA 8"  
OPAL MATT B/F  
PATINA BLK

**B22**  
H-22cm W-21cm



3020007

ST KILDA 14"  
OPAL MATT  
3 CHAIN  
BLACK CORD  
SUSP  
PATINA BLK

**B22**  
H-100cm (ADJ)  
W-34cm

**NOTE -**  
3 CHAIN  
SUSPENSION  
ARE  
SUPPLIED  
IN  
A  
1 METER  
DROP  
WITH  
HOOKS

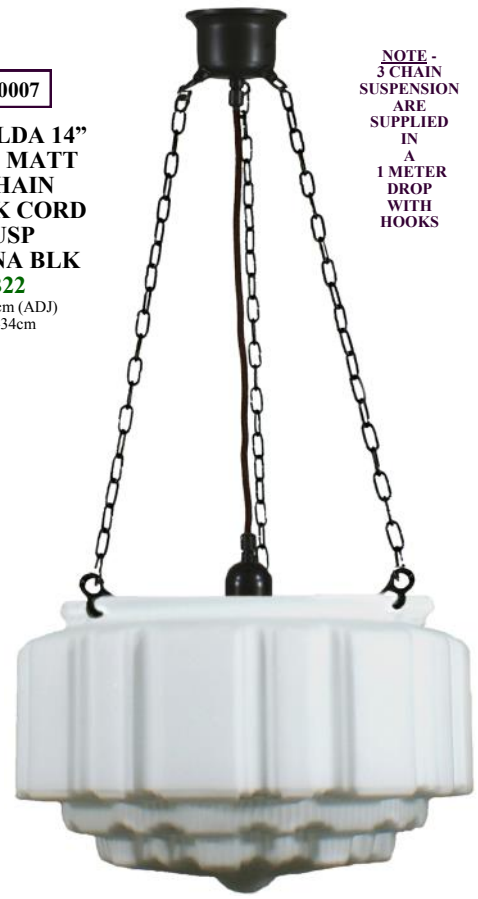

3020010

ST KILDA 14"  
OPAL MATT  
B/F PATINA BLK

**B22**  
H-29cm W-36cm



# Senator Range

3020134

SENATOR 17" OPAL MATT  
3 CHAIN  
BLACK CORD  
SUSP  
PATINA BLK  
B22  
H-100cm (ADJ)  
W-42cm



NOTE -  
3 CHAIN  
SUSPENSION  
ARE  
SUPPLIED  
IN  
A  
1 METER  
DROP  
WITH  
HOOKS

3020006

SENATOR 14" OPAL MATT  
3 CHAIN  
BLACK CORD  
SUSP  
PATINA BLK  
B22  
H-100cm (ADJ)  
W-34cm

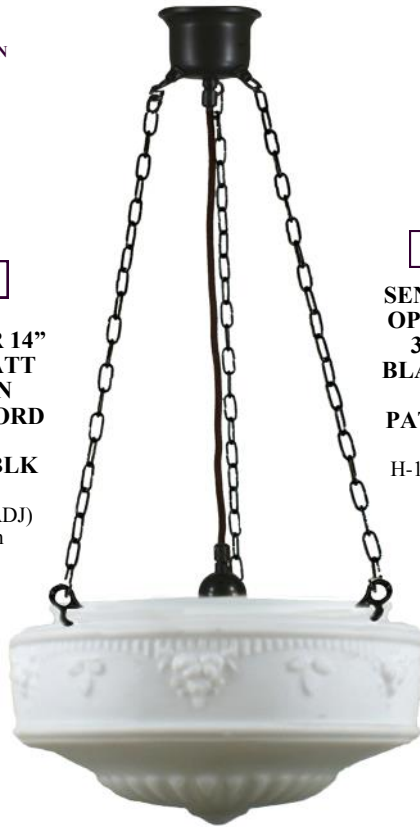

3020004

SENATOR 11" OPAL MATT  
3 CHAIN  
BLACK CORD  
SUSP  
PATINA BLK  
B22  
H-100cm (ADJ)  
W-28cm



NOTE -  
CLOTH CORD  
SET  
SUSPENSIONS  
ARE  
SUPPLIED  
IN  
A  
1 METER  
DROP.

3020059

SENATOR 8" OPAL MATT  
CLOTH  
CORD SUSP  
PATINA BLK  
B22  
H-100cm(ADJ)  
W-20cm



## Patina Black

3020120

SENATOR 8" OPAL MATT  
ROD PND 1/2"  
PATINA BLK  
B22  
H-75cm (ADJ)  
W-20cm



3020009

SENATOR 14" OPAL MATT  
B/F PATINA BLK B22  
H-32cm W-36cm



NOTE -  
HALF  
METER  
1/2" & 3/4"  
ROD  
&  
JOINER  
EXTENSIONS  
AVAILABLE

3020112

SENATOR 14" OPAL MATT  
ROD PND 3/4"  
PATINA BLK  
B22  
H-75cm(ADJ)  
W-36cm



3020102

SENATOR 11" OPAL MATT  
ROD PND 3/4"  
PATINA BLK  
B22  
H-70cm(ADJ)  
W-28cm



NOTE -  
CHAIN  
SET  
SUSPENSIONS  
ARE  
SUPPLIED  
IN  
A  
1 METER  
DROP.

3020052

SENATOR  
8" OPAL  
MATT  
SINGLE  
CHAIN  
BLACK  
CORD SUSP  
PATINA  
BLK  
B22  
H-100cm(ADJ)  
W-20cm



3020043

SENATOR 11" OPAL MATT  
B/F PATINA BLK B22  
H-28cm W-28cm



3020029

SENATOR 8" OPAL MATT  
B/F PATINA BLK B22  
H-23cm W-20cm



# Empire Range



NOTE - CLOTH CORD SET SUSPENSIONS ARE SUPPLIED IN A 1 METER DROP.

3020069

EMPIRE 8" OPAL MATT CLOTH BLACK CORD SUSP PATINA BLK B22  
H-100cm(ADJ) W-20cm



NOTE - CHAIN SET SUSPENSIONS ARE SUPPLIED IN A 1 METER DROP.

3020068

EMPIRE 8" OPAL MATT SINGLE CHAIN BLACK CORD SUSP PATINA BLK B22  
H-100cm(ADJ) W-20cm



3020118

EMPIRE 8" OPAL MATT ROD PND 1/2" PATINA BLK B22  
H-100cm (ADJ) W-20cm



3020111

NOTE - HALF METER 1/2" & 3/4" ROD & JOINER EXTENSIONS AVAILABLE

EMPIRE 14" OPAL MATT ROD PND 3/4" PATINA BLK B22  
H-100cm(ADJ) W-36cm

## Patina Black



3020026

EMPIRE 8" OPAL MATT B/F PATINA BLK B22  
H-27cm W-20cm

3020005

EMPIRE 14" OPAL MATT 3 CHAIN SUSP PATINA BLK B22  
H-100cm(ADJ) W-36cm

NOTE - 3 CHAIN SUSPENSION ARE SUPPLIED IN A 1 METER DROP WITH HOOKS



3020008

EMPIRE 14" OPAL MATT B/F PATINA BLK B22  
H-25cm W-36cm

# Premier Range

3020135

**PREMIER 8" OPAL MATT CLOTH BLACK CORD SUSP PATINA BLK B22**  
H-100cm(ADJ)  
W-23cm

**NOTE - CLOTH CORD SET SUSPENSIONS ARE SUPPLIED IN A 1 METER DROP.**

3020136

**PREMIER 8" OPAL MATT SINGLE CHAIN BLACK CORD SUSP PATINA BLK B22**  
H-100cm(ADJ)  
W-23cm

**NOTE - CHAIN SET SUSPENSIONS ARE SUPPLIED IN A 1 METER DROP.**

3020119

**PREMIER 8" OPAL MATT ROD PND 1/2" PATINA BLK B22**  
H-75cm(ADJ)  
W-23cm

3020107

**PREMIER 12" OPAL MATT ROD PND 3/4" PATINA BLK B22**  
H-80cm(ADJ)  
W-30cm

**NOTE - HALF METER 1/2" & 3/4" ROD & JOINER EXTENSIONS AVAILABLE**

*Patina  
Black*

3020028

**PREMIER 8" OPAL MATT B/F PATINA BLK B22**  
H-23cm W-23cm

3020070

**PREMIER 12" OPAL MATT 3 CHAIN BLACK CORD SUSP PATINA BLK B22**  
H-100cm(ADJ)  
W-30cm

**NOTE - 3 CHAIN SUSPENSION ARE SUPPLIED IN A 1 METER DROP WITH HOOKS**

3020044

**PREMIER 12" OPAL MATT B/F PATINA BLK B22**  
H-32cm W-30cm

# Sphere Range



3020015

**SPHERE 6" OPAL GLOSS B/F PATINA BLK B22**  
H-17cm W-15cm

3020027

**SPHERE 8" OPAL GLOSS B/F PATINA BLK B22**  
H-22cm W-20cm



3020020

**SPHERE 10" OPAL GLOSS B/F PATINA BLK B22**  
H-28cm W-25cm



3020022

**SPHERE 12" OPAL GLOSS B/F PATINA BLK B22**  
H-34cm W-30cm



3020055

**SPHERE 10" OPAL GLOSS SINGLE CHAIN SUSP BROWN CORD PATINA BLK B22**

H-100cm +(ADJ) W-25cm

*NOTE - CHAIN SET SUSPENSIONS ARE SUPPLIED IN A 1 METER DROP.*



3020115

**SPHERE 8" OPAL GLOSS ROD PND 1/2" PATINA BLK B22**

H-74cm (ADJ) W-20cm



3020099

**SPHERE 10" OPAL GLOSS ROD PND 1/2" PATINA BLK B22**

H-80cm (ADJ) W-25cm



3020103

**SPHERE 12" OPAL GLOSS ROD PND 3/4" PATINA BLK B22**

H-86cm (ADJ) W-30cm



*NOTE - HALF METER 1/2" & 3/4" ROD & JOINER EXTENSIONS AVAILABLE*

3020030

**SHEFFIELD 8" B/F PATINA BLK B22**

H-22cm W-20cm



3020021

**SHEFFIELD 10" B/F PATINA BLK B22**

H-28cm W-25cm



3020023

**SHEFFIELD 12" B/F PATINA BLK B22**

H-34cm W-30cm



3020017

**SHEFFIELD 6" B/F PATINA BLK B22**

H-17cm W-15cm



3020137

**SHEFFIELD 10" SINGLE CHAIN SUSP BROWN CORD PATINA BLK B22**

H-100cm +(ADJ) W-25cm

*NOTE - CHAIN SET SUSPENSIONS ARE SUPPLIED IN A 1 METER DROP.*

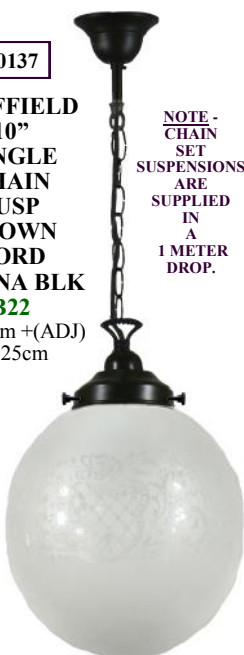

3020116

**SHEFFIELD 8" ROD PND 1/2" PATINA BLK B22**

H-74cm (ADJ) W-20cm



3020100

**SHEFFIELD 10" ROD PND 1/2" PATINA BLK B22**

H-80cm (ADJ) W-25cm



3020104

**SHEFFIELD 12" ROD PND 3/4" PATINA BLK B22**

H-86cm (ADJ) W-30cm



*NOTE - HALF METER 1/2" & 3/4" ROD & JOINER EXTENSIONS AVAILABLE*

*Patina Black*



*Rod Set Range*

3020114

VICTORIAN  
16" SCHOOLHOUSE  
OPAL GLOSS  
ROD PND 3/4"  
PATINA BLK  
B22  
H-85cm(ADJ)  
W-40cm

NOTE -

HALF  
METER  
1/2" & 3/4"  
ROD  
&  
JOINER  
EXTENSIONS  
AVAILABLE

3020108

VICTORIAN  
12" SCHOOLHOUSE  
OPAL GLOSS  
ROD PND 3/4"  
PATINA BLK  
B22  
H-75cm(ADJ)  
W-30cm

3020127

VICTORIAN  
9" SCHOOLHOUSE  
OPAL GLOSS  
ROD PND 1/2"  
PATINA BLK  
B22  
H-70cm(ADJ)  
W-23cm



3020034

VICTORIAN 9" SCHOOLHOUSE  
OPAL GLOSS B/F PATINA BLK B22  
H-19cm W-23cm

3020024

VICTORIAN 12" SCHOOLHOUSE  
OPAL GLOSS  
B/F PATINA BLK B22  
H-23cm W-30cm

3020040

VICTORIAN 16" SCHOOLHOUSE  
OPAL GLOSS  
B/F PATINA BLK B22  
H-30cm W-40cm

NOTE -

HALF  
METER  
1/2" & 3/4"  
ROD  
&  
JOINER  
EXTENSIONS  
AVAILABLE

3020132

LINCOLN SCHOOLHOUSE  
OPAL GLOSS  
ROD PND 3/4"  
PATINA BLK  
B22  
H-85cm (ADJ)  
W-36cm



3020042

LINCOLN SCHOOLHOUSE  
OPAL GLOSS B/F PATINA BLK B22  
H-27cm W-36cm

*Patina Black*

# Rod Set Range

# Patina Black

3020110

**DETROIT 14" OPAL GLOSS ROD PND 3/4" PATINA BLK**  
**B22**  
 H-78cm(ADJ)  
 W-34cm

3020117

**DETROIT 8" OPAL GLOSS ROD PND 3/4" PATINA BLK**  
**B22**  
 H-72cm(ADJ)  
 W-20cm

3020039

**DETROIT 14" OPAL GLOSS B/F PATINA BLK**  
**B22**  
 H-28cm W-34cm

3020128

**BERGERAC OPAL MATT ROD PND 3/4" PATINA BLK**  
**B22**  
 H-94cm (ADJ)  
 W-26cm

**NOTE -**  
 HALF METER 1/2" & 3/4" ROD & JOINER EXTENSIONS AVAILABLE

3020025

**DETROIT 8" OPAL GLOSS B/F PATINA BLK**  
**B22**  
 H-24cm W-20cm

3020133

**MOULINS OPAL GLOSS ROD PND 3/4" PATINA BLK**  
**B22**  
 H-70cm(ADJ)  
 W-30cm

3020037

**MOULINS OPAL GLOSS B/F PATINA BLK**  
**B22**  
 H-21cm W-30cm

3020130

**CHATEAU OPAL GLOSS ROD PND 1/2" PATINA BLK**  
**B22**  
 H-70cm(ADJ)  
 W-28cm

3020041

**CHATEAU OPAL GLOSS B/F PATINA BLK**  
**B22**  
 H-21cm W-30cm

# Rod Set Range

## Patina Black

3020129

CANNES  
OPAL GLOSS  
ROD PND  
3/4"  
PATINA BLK  
B22  
H-70cm(ADJ)  
W-22cm



3020038

DERBY 13"  
OPAL MATT B/F  
PATINA BLK B22  
H-30cm W-33cm



3020109

DERBY 13"  
OPAL MATT  
ROD PND 3/4"  
PATINA BLK  
B22  
H-80cm(ADJ)  
W-33cm



3020125

DERBY 9"  
OPAL MATT  
ROD PND 3/4"  
PATINA BLK  
B22  
H-75cm(ADJ)  
W-23cm



3020033

DERBY 9"  
OPAL MATT B/F  
PATINA BLK B22  
H-25cm W-23cm



3020035

CANNES  
OPAL GLOSS B/F  
PATINA BLK B22  
H-19cm W-22cm



3020131

DOMEC  
OPAL GLOSS  
ROD PND 3/4"  
PATINA BLK  
B22  
H-70cm(ADJ)  
W-20cm



3020036

DOMEC  
OPAL GLOSS B/F  
PATINA BLK B22  
H-21cm W-20cm



3020019

BEEHIVE 10"  
OPAL GLOSS B/F  
PATINA BLK B22  
H-22cm W-25cm



3020018

PARKVILLE 9"  
OPAL GLOSS B/F  
PATINA BLK B22  
H-21cm W-23cm



NOTE -  
HALF  
METER  
1/2" & 3/4"  
ROD  
&  
JOINER  
EXTENSIONS  
AVAILABLE

3020101

BEEHIVE 10" OPAL GLOSS  
ROD PND 3/4" PATINA BLK B22  
H-70cm (ADJ) W-25cm



3020126

PARKVILLE 9" OPAL GLOSS  
ROD PND 3/4" PATINA BLK B22  
H-68cm(ADJ) W-23cm



# Paramount Range

# Patina Black

1000699

PARAMOUNT  
LINCOLN  
SCHOOLHOUSE  
1/LT PND  
BLACK FLEX  
PATINA BLK

E27  
FRAME SIZE  
WITH OUT CHAIN-  
1MT CHAIN SUPPLIED  
H-44cm(ADJ)  
W-36cm

1000389

PARAMOUNT  
VICTORIAN 12"  
SCHOOLHOUSE  
1/LT PND  
BLACK FLEX  
PATINA BLK

E27  
FRAME SIZE  
WITH OUT CHAIN-  
1MT CHAIN SUPPLIED  
H-41cm(ADJ)  
W-30cm

1000698

PARAMOUNT  
VICTORIAN 9"  
SCHOOLHOUSE  
1/LT PND  
BLACK FLEX  
PATINA BLK

E27  
FRAME SIZE  
WITH OUT CHAIN-  
1MT CHAIN SUPPLIED  
H-34cm(ADJ)  
W-23cm

1000680

PARAMOUNT  
VICTORIAN 16"  
SCHOOLHOUSE  
1/LT PND  
BLACK FLEX  
PATINA BLK

E27  
FRAME SIZE  
WITH OUT CHAIN-  
1MT CHAIN SUPPLIED  
H-45cm(ADJ)  
W-40cm

1000701

PARAMOUNT  
CHATEAU  
1/LT PND  
BLACK FLEX  
PATINA BLK E27

FRAME SIZE  
WITH OUT CHAIN-  
1MT CHAIN SUPPLIED  
H-36cm(ADJ) W-30cm

1000707

PARAMOUNT  
CANNES  
1/LT PND  
BLACK FLEX  
PATINA BLK

E27  
FRAME SIZE  
WITH OUT CHAIN-  
1MT CHAIN SUPPLIED  
H-38cm(ADJ)  
W-22cm

1000392

PARAMOUNT  
DETROIT 14"  
OPAL GLOSS  
1/LT PND  
BLACK FLEX  
PATINA BLK

E27  
FRAME SIZE  
WITH OUT CHAIN-  
1MT CHAIN SUPPLIED  
H-42cm(ADJ)  
W-35cm

1000386

PARAMOUNT  
MOULINS  
1/LT PND  
BLACK FLEX  
PATINA BLK

E27  
FRAME SIZE  
WITH OUT CHAIN-  
1MT CHAIN SUPPLIED  
H-37cm(ADJ)  
W-30cm

1000697

PARAMOUNT  
ST KILDA 9"  
1/LT PND  
BLACK FLEX  
PATINA BLK

E27  
FRAME SIZE  
WITH OUT CHAIN-  
1MT CHAIN SUPPLIED  
H-41cm(ADJ)  
W-21cm

# Paramount Range

1000686

**PARAMOUNT  
OPAL GLOSS  
12" SPHERE  
1/LT PND  
BLACK FLEX  
PATINA BLK  
E27**  
FRAME SIZE  
WITH OUT CHAIN  
1MT CHAIN SUPPLIED  
H-52cm(ADJ)  
W-30cm



1000681

**PARAMOUNT  
OPAL GLOSS  
10" SPHERE  
1/LT PND  
BLACK FLEX  
PATINA BLK  
E27**  
FRAME SIZE  
WITH OUT CHAIN  
1MT CHAIN SUPPLIED  
H-46cm(ADJ)  
W-25cm



1000721

**PARAMOUNT  
OPAL GLOSS  
8" SPHERE  
1/LT PND  
BLACK FLEX  
PATINA BLK  
E27**  
FRAME SIZE  
WITH OUT CHAIN  
1MT CHAIN SUPPLIED  
H-41cm(ADJ)  
W-20cm



1000706

**PARAMOUNT  
BEEHIVE  
1/LT PND  
BLACK FLEX  
PATINA BLK  
E27**  
FRAME SIZE  
WITH OUT CHAIN  
1MT CHAIN SUPPLIED  
H-41cm(ADJ)  
W-25cm



*Patina  
Black*

1000720

**PARAMOUNT  
PARKVILLE 9"  
1/LT PND  
BLACK FLEX  
PATINA BLK  
E27**  
FRAME SIZE  
WITH OUT CHAIN-  
1MT CHAIN SUPPLIED  
H-40cm(ADJ)  
W-23cm



1000719

**PARAMOUNT  
DOMEC  
1/LT PND  
BLACK FLEX  
PATINA BLK  
E27**  
FRAME SIZE  
WITH OUT CHAIN  
1MT CHAIN SUPPLIED  
H-40cm(ADJ)  
W-20cm



1000717

**PARAMOUNT  
DERBY 9"  
1/LT PND  
BLACK FLEX  
PATINA BLK  
E27**  
FRAME SIZE  
WITH OUT CHAIN  
1MT CHAIN SUPPLIED  
H-44cm(ADJ)  
W-23cm



1000718

**PARAMOUNT  
DERBY 13"  
1/LT PND  
BLACK FLEX  
PATINA BLK  
E27**  
FRAME SIZE  
WITH OUT CHAIN  
1MT CHAIN SUPPLIED  
H-48cm(ADJ)  
W-33cm



# Claredon Range

1000453

CLAREDON 12"  
ASTON PND  
3/4"  
PATINA BLK  
E27  
H-65cm (ADJ)  
W-31cm

NOTE -  
HALF  
METER  
1/2" & 3/4"  
ROD  
&  
JOINER  
EXTENSIONS  
AVAILABLE

# Patina Black

1000682

PARAMOUNT  
CLAREDON 12"  
1/LT PND  
BLACK FLEX  
PATINA BLK  
E27  
FRAME SIZE  
WITH OUT CHAIN  
1MT CHAIN SUPPLIED  
H-34cm(ADJ)  
W-30cm



1000457

CLAREDON 15"  
ASTON PND  
3/4"  
PATINA BLK  
E27  
H-70cm (ADJ)  
W-38cm



1000687

PARAMOUNT  
CLAREDON 15"  
1/LT PND  
BLACK FLEX  
PATINA BLK  
E27  
FRAME SIZE  
WITH OUT CHAIN  
1MT CHAIN SUPPLIED  
H-38cm(ADJ)  
W-37cm



3020078

CLAREDON 6"  
B/F PATINA BLK  
B22  
H-20cm W-15cm



*Wall  
Bracket  
Range*

*Patina  
Black*



3020146

**KOSCINA 1/LT W/B  
SPHERE 6" OPAL GLOSS  
PATINA BLK B22**  
H-26cm W-15cm P-16cm



3020143

**KOSCINA 1/LT W/B CONO OPAL MATT  
PATINA BLK B22**  
H-20cm W-14cm P-16cm



3020142

**KOSCINA 1/LT W/B CONO CLEAR  
PATINA BLK B22**  
H-20cm W-14cm P-16cm



3020148

**KOSCINA 1/LT W/B ZIPPER 23 FROST  
PATINA BLK B22**  
H-22cm W-12cm P-16cm



3020147

**KOSCINA 1/LT W/B ZIPPER 23 CLEAR  
PATINA BLK B22**  
H-22cm W-12cm P-16cm



3020144

**KOSCINA 1/LT W/B DECATRON OPAL MATT  
PATINA BLK B22**  
H-19cm W-12cm P-16cm



3020145

**KOSCINA 1/LT W/B CLAREDON SMALL  
PATINA BLK B22**  
H-20cm W-16cm P-16cm



# Glassware Range



3090020

**CAMBRIDGE  
FROST ETCHED BRASS**  
4 1/4" FITTER  
H-320mm W-220mm



3090005

**ZIPPER 23 FROST**  
2 1/4" FITTER  
H-115mm W-118mm



3090004

**ZIPPER 23 CLEAR**  
2 1/4" FITTER  
H-115mm W-118mm



3090009

**5008/29mm  
FROST/ETCHED**  
29mm HOLE  
H-120mm W-140mm



3090007

**ZIPPER 43 FROST**  
2 1/4" FITTER  
H-100mm W-175mm



3090006

**ZIPPER 43 CLEAR**  
2 1/4" FITTER  
H-100mm W-175mm



3090033

**DECATRON  
OPAL MATT**  
29mm HOLE  
H-95mm W-120mm



3090032

**CONO OPAL MATT**  
29mm HOLE  
H-100mm W-145mm



3090031

**CONO CLEAR**  
29mm HOLE  
H-100mm W-145mm



3090027

**CLAREDON SMALL - CLEAR**  
2 1/4" FITTER  
H-95mm W-168mm



3090023

**CLAREDON 12" MEDIUM - CLEAR**  
43mm HOLE  
H-150mm W-310mm



3090025

**CLAREDON 15" LARGE - CLEAR**  
50mm HOLE  
H-190mm W-380mm



3090061

**SPHERE 12" OPAL GLOSS**  
4 1/4" FITTER  
H-310mm W-300mm



3090060

**SPHERE 10" OPAL GLOSS**  
4 1/4" FITTER  
H-260mm W-250mm



3090063

**SPHERE 8" OPAL GLOSS**  
4 1/4" FITTER  
H-210mm W-200mm



3090062

**SPHERE 6" OPAL GLOSS**  
3 1/4" FITTER  
H-155mm W-150mm



3090055

**SHEFFIELD 12" FRENCH ETCHED**  
4 1/4" FITTER  
H-310mm W-300mm



3090054

**SHEFFIELD 10" FRENCH ETCHED**  
4 1/4" FITTER  
H-260mm W-250mm



3090057

**SHEFFIELD 8" FRENCH ETCHED**  
4 1/4" FITTER  
H-210mm W-200mm



3090056

**SHEFFIELD 6" FRENCH ETCHED**  
3 1/4" FITTER  
H-155mm W-150mm



# Glassware Range



3090068

**VICTORIAN 16" SCHOOLHOUSE  
OPAL GLOSS**  
6 1/4" FITTER  
H-270mm W-400mm



3090067

**VICTORIAN 12" SCHOOLHOUSE  
OPAL GLOSS**  
4 1/4" FITTER  
H-210mm W-300mm



3090069

**VICTORIAN 9" SCHOOLHOUSE  
OPAL GLOSS**  
4 1/4" FITTER  
H-165mm W-230mm



3090036

**DETROIT LARGE  
OPAL GLOSS**  
6 1/4" FITTER  
H-220mm W-340mm



3090037

**DETROIT SMALL  
OPAL GLOSS**  
4 1/4" FITTER  
H-120mm W-200mm



3090042

**LINCOLN SCHOOLHOUSE  
OPAL GLOSS**  
6 1/4" FITTER  
H-240mm W-360mm



3090043

**MOULINS  
OPAL GLOSS**  
4 1/4" FITTER  
H-180mm W-300mm



3090022

**CHATEAU  
OPAL GLOSS**  
6 1/4" FITTER  
H-150mm W-300mm



3090017

**BEEHIVE 10"  
OPAL GLOSS**  
4 1/4" FITTER  
H-185mm W-250mm



3090038

**DOMEC  
OPAL GLOSS**  
4 1/4" FITTER  
H-190mm W-200mm



3090045

**PARKVILLE 9"  
OPAL GLOSS**  
4 1/4" FITTER  
H-180mm W-220mm



3090021

**CANNES  
OPAL GLOSS**  
4 1/4" FITTER  
H-135mm W-220mm

# Glassware Range



3090053

**SENATOR 8"**  
**OPAL MATT**  
4 1/4" FITTER  
H-220mm W-200mm



3090018

**BERGERAC**  
**OPAL MATT**  
6 1/4" FITTER  
H-410mm W-225mm



3090066

**ST KILDA 9"**  
**OPAL MATT**  
4 1/4" FITTER  
H-200mm W-210mm



3090064

**ST KILDA 14"**  
**OPAL MATT**  
12 1/4" FITTER  
H-220mm W-360mm



3090050

**SENATOR 11"**  
**OPAL MATT**  
8 1/4" FITTER  
H-155mm W-280mm



3090035

**DERBY 9"**  
**OPAL MATT**  
4 1/4" FITTER  
H-180mm W-220mm



3090034

**DERBY 13"**  
**OPAL MATT**  
6 1/4" FITTER  
H-240mm W-320mm



3090051

**SENATOR 14"**  
**OPAL MATT**  
12 1/4" FITTER  
H-180mm W-355mm



3090047

**PREMIER 8"**  
**OPAL MATT**  
4 1/4" FITTER  
H-195mm W-200mm



3090046

**PREMIER 12"**  
**OPAL MATT**  
8 1/4" FITTER  
H-265mm W-310mm



3090052

**SENATOR 17"**  
**OPAL MATT**  
3 CHAIN SUSPENSION ONLY -  
H-220mm W-425mm



3090040

**EMPIRE 8"**  
**OPAL MATT**  
4 1/4" FITTER  
H-245mm W-200mm



3090039

**EMPIRE 14"**  
**OPAL MATT**  
12 1/4" FITTER  
H-190mm W-340mm

*Metal Shade  
Range*

The Original Coolie Metal Shade



3090277

**EDWARDIAN**  
250mm  
**WHITE**  
29mm HOLE



3090275

**EDWARDIAN**  
250mm  
**BLACK**  
29mm HOLE



3090280

**EDWARDIAN**  
390mm  
**WHITE**  
29mm HOLE



3090278

**EDWARDIAN**  
390mm  
**BLACK**  
29mm HOLE

The Original Warehouse / Tennis Court Metal Shade



3090283

**WAREHOUSE**  
300mm  
**WHITE**  
29mm HOLE



3090281

**WAREHOUSE**  
300mm  
**BLACK**  
29mm HOLE



3090286

**WAREHOUSE**  
420mm  
**WHITE**  
29mm HOLE



3090284

**WAREHOUSE**  
420mm  
**BLACK**  
29mm HOLE

# Lighting Inspirations

## \* Conditions Of Sale \*

\* **Payment** terms, Strictly Nett: 30 Days - For customers with approved credit facilities.

\* **Prices** can change without notification. Prices exclude GST.

\* **Approved** 30 day credit application only.

\* **Credits** approved or authorized only by fax/email confirmation from Lode International.

No goods may be returned without Lode International authorization.

Product must be unopened and returned in its original packing.

\* **Electrically Faulty** installed product, confirmed by qualified Electrician are covered by Lode International.

If this product is found not to be electrically faulty or retailers customer decides product is not suitable, wrong size, etc a 30% restocking fee, freight charges & breakage charges if applicable will be applied.

\* **Claims** no later than 7 days from date of delivery, invoice numbers must be quoted.

\* **Retention** of title until payment received as detailed on original invoices.

\* **All images**, drawings, particulars, specifications, weights, and dimensions & all promotional material used by Lode International is intended to be illustrative only. None of the foregoing nor any particulars or representations contained therein shall form part nor deemed to have been incorporated in any contract with Lode International. Lode International reserves the right to change product dimensions and technical details at any time without notice.

### \* Freight To Your Shop/Store \*

**F.I.S - Australia - For Orders Over \$300.00 + G.S.T**

**To** - Melbourne Metro - Sydney Metro - Brisbane Metro - Adelaide Metro - Canberra Metro - Perth Metro

**For Orders Under \$300.00 + G.S.T Incur Surcharge Of \$30.00 + G.S.T**

**F.O.B - Melbourne - For Orders Over \$300.00 + G.S.T**

**To** - Tasmania - Darwin - Regional Country Australia Wide

**For Orders Under \$300.00 + G.S.T Incur Surcharge Of \$30.00 + G.S.T**

### \* Freight Delivered Directly to Your Customer \*

**To** - Melbourne Metro - Sydney Metro - Brisbane Metro - Adelaide Metro - Canberra Metro - Perth Metro

Freight to a commercial or private address of the end customer \$30.00 + G.S.T plus \$ 10.00 + G.S.T for each carton.

If freight is going to a private address we must receive a written "authority to leave" confirmation from the end customer with your order, stating that the freight company can leave the shipment at the detailed location if no one is present.

Note - If for whatever reason freight delivery requires more than one attempt, extra freight charge will apply.

**To** - Tasmania - Darwin - Regional Country Australia Wide

Ring to obtain a freight quote for delivery to a commercial or private address of the end customer.

If freight is going to a private address we must receive a written "authority to leave" confirmation from the end customer with your order, stating that the freight company can leave the shipment at the detailed location if no one is present.

Note - If for whatever reason freight delivery requires more than one attempt, extra freight charge will apply.

### \* To The Customer \*

It is important that we and our retailers advise our clients of the unique characteristics of our products.

As our products are hand made and finished, they will not be perfect and we see this as their unique appeal.

Therefore -

- Metal castings and extrusions will have imperfections in the surface. Lamp holders may not be perfectly straight.
- Hand welding will not be perfectly straight and there may be surface finish imperfections due to chemical plating & hand finishing.
- Hand-blown glassware may have bubbles, pin dots, slight lines, rippling, cut edges & be slightly off center.
- Paint color will vary from batch to batch & in case of hand painted finish, each product will be marginally different.

### \* Please Note \*

- \* All items are inspected for visible defects before dispatch, we therefore also recommend the retailer does the same before giving to their customer in case of damage in transit. If not inspected, Lode Int. will not accept liability for installation or any other claims for visibly faulty goods. Report any breakage or faults immediately before giving to your customer for replacement parts or fitting.
- \* We will not recognize or accept any unreasonable claim relating to the unique characteristics of our hand made products.
- \* Products can only be returned if unopened and in original packaging.
- \* Products modified to customer request not to be returned.
- \* Products ordered separately over time may not match exactly because of color batching or manufacturing changes. No claim related to separate ordering over time will be recognized.
- \* Products can change or vary without notice.
- \* Images are the property of Lode International. Images of products are illustrative only. Their use is only permissible with written consent.
- \* Lode International is not liable for damage/altering the integrity of the light fittings due to faulty globes.
- \* Lode International is an accredited E.R.A.C "Responsible Supplier". To Check Compliance - EESS.gov.au - Lode Lighting / ESV-106126
- \* Type of [Globe Required Chart](#) and [IP Rating Chart](#) are on [Page 107](#).

E2722

