

HEATSTRIP[®]

Nano Electric Heater Product Manual

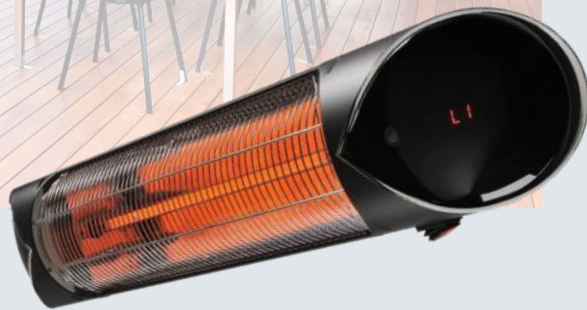

HEATSTRIP[®] Nano (THN)

www.heatstrip.com.au

Ph: 03 9562 3455 | E: sales@thermofilm.com.au

HEATSTRIP®

Innovative, Infra-red Electric Heating Technology

Features & Benefits

High Output radiant heat

HEATSTRIP® Nano electric radiant heaters produce radiant heat that travels through the air directly to people and surfaces below – similar to the heat rays emitted by the Sun. Radiant heating is the only viable option for outdoor or tough indoor sites.

Radiant heat performance – multiple applications

The medium temperature output of the HEATSTRIP® Nano is perfect for spot heating of outdoor protected sites and most indoor applications, such as garages, sheds, bathrooms, living rooms, bedrooms, showrooms, restaurants, warehouse, café etc.

Corrosion protection

Built from corrosion resistant alloy, it is suitable for use in most applications, including difficult corrosive environments such as coastal areas. For exposed or windy areas, we would recommend the HEATSTRIP Intense or Max ranges.

Multi-Purpose Mounting Options

The HEATSTRIP® Nano is supplied with flexible mounting options. The standard bracket will allow both ceiling and wall mounting, at various angles, as well as suspension by chains or wires (Chain/wires not included).

DIY

The THN2000 (2000W) is supplied with a lead and plug, and is therefore ideal for DIY installations with brackets included.

Element

Carbon filament infra-red heating element provides infrared performance, instant heat.

Warranty

18 month residential and 12 month commercial warranty.

Material & Design

Anodised alloy casing with a stainless steel grille.

Remote Control function

24 hour countdown timer control with 4 heat settings.



HEATSTRIP®

Specifications - Australia

MODEL	POWER (WATTS)	CURRENT (AMPS)	DIMENSIONS (mm)	WEIGHT (Kg)	LEAD LENGTH (mm)	PLUG
THN2000	2000	8.3	900 x 130 x 89.5	3	2000	YES

MODEL		
HEATER TYPE	Electric radiant, infra-red overheat heater with carbon filament element.	
OUTPUT	800 / 1200 / 1600 / 2000 Watts	
POWER	230-240 Volts Nominal at 50—60 Hertz, Single Phase	
CONNECTION	3 Core Cable 2.5mm ²	
APPROVALS	AUSTRALIA / NZ / EU	
MOUNTING HEIGHT	MINIMUM RECOMMENDED MAXIMUM	1.8 m 2.1 m - 2.3 m 2.5m Outdoors and 2.7m Indoors
MOUNTING OPTIONS	Suitable for ceiling, wall, and beam mounting as well as suspension by chains & wires using standard brackets.	
PROTECTION RATING	IP55 Protection from water ingress from all directions	
MATERIALS OF CONSTRUCTION	Anodised alloy casing with stainless steel grille (304SS)	

THN2000

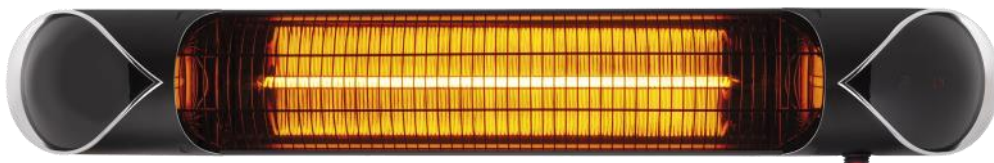

HEATSTRIP®

Spot heating principle

In most outdoor or difficult-to-heat indoor applications, there are 2 methods when looking at the quantity of heaters required.

Option 1 is to comfort heat the entire area based on the total dimensions of the space, regardless of whether the entire area is being fully occupied or not.

Option 2 is to spot heat the high use areas, such as over outdoor tables, BBQ's, lounges, assembly lines or indoor workstations.

Often it is more practical and efficient to spot heat these areas. Spot heating will help to reduce the initial capital cost, as well as the on-going running costs. Spot heating will allow the area to be "zoned", meaning heating only the areas that are being used, such as tables in a restaurant or outdoor alfresco area.

The top diagram shows how HEATSTRIP® Nano is recommended to be used directly over a table, while the bottom diagram indicates how to spot heat a large area.

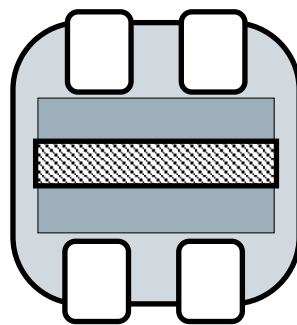

THN2000 over table

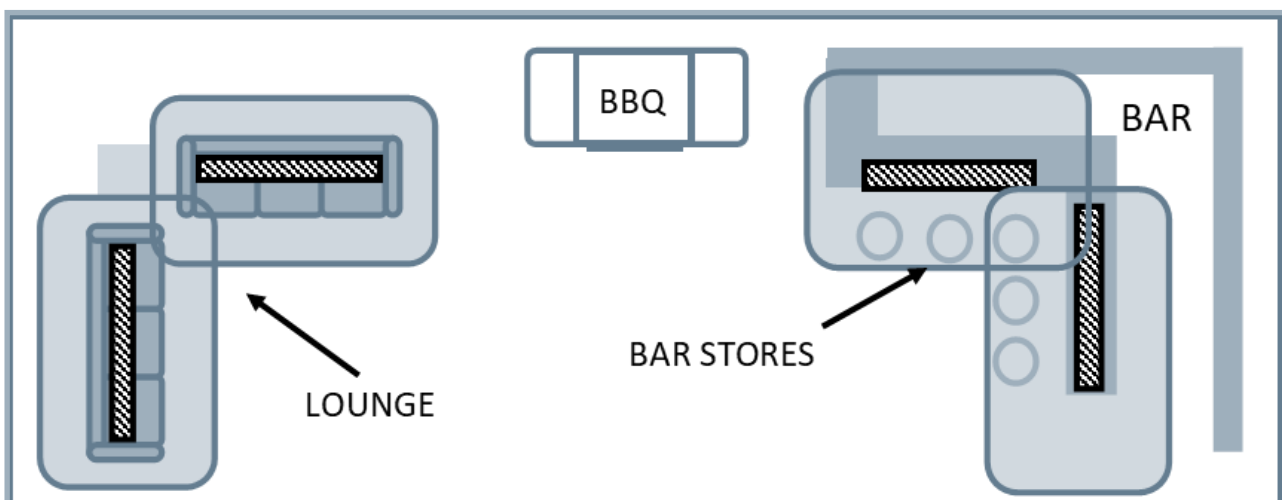

HEATSTRIP®

Selection guide

General recommendations for **HEATSTRIP® Nano**:

Ideal mounting height: 2.1m to 2.3m, and the maximum 2.5m outdoors and 2.7m indoors.

- Ideal mounting location: ceiling mounted, directly above area to be heated (eg. above a table)

Can also be wall mounted and angled downwards. For wall mounting applications, the heating area and radiant footprint is reduced.

The below table outlines the coverage HEATSTRIP® Nano model (in m²), based on 2 different scenarios. For example, in an outdoor area that is protected from prevailing winds by walls, café blinds etc, (eg outdoor enclosed)

We do not recommend this model for use in exposed outdoor locations. Use HEATSTRIP Max or Intense range.

This data is based on direct overhead ceiling mounting. If the heaters are wall mounted, the radiant footprint will be reduced.

Above data is based on direct overhead ceiling mounting. If the heaters are wall mounted, the radiant footprint may be reduced.

The below diagrams show the approximate heating area for each model, based on both an indoor protected, outdoor enclosed and outdoor exposed location.

MODEL	INDOOR PROTECTED (m ²)	OUTDOOR ENCLOSED (m ²)	OUTDOOR EXPOSED
THN2000	8 m ²	Spot heating (4-5 m ²)	N/A



HEATSTRIP®

Installation Requirements

The ideal mounting position for the HEATSTRIP® Nano is on the ceiling, directly above the area to be heated. If this is not possible, HEATSTRIP® Nano can be mounted on a wall and angled downwards. In this situation, ensure the mounting height is in the range of 2.1m to 2.3m.

For ceiling mounting heights more than 2.5m outdoors, we recommend the use of the chains or wires to reduce the height of the heater to 2.1m—2.3m. This will increase the effectiveness of your HEATSTRIP®.

Electrical connections/GPO's should not be located at the back of the heater. They should be located outside the physical footprint of the units to minimize heat build-up behind the units.

The HEATSTRIP® Nano is not suitable for mounting on an incline, along the length.

This Model may be hardwired and connected to an On/Off switch. In this situation, the heater must be installed by a licenced electrician.

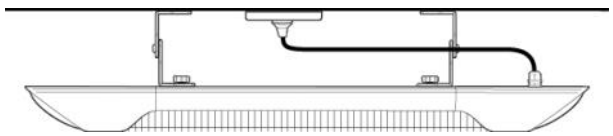
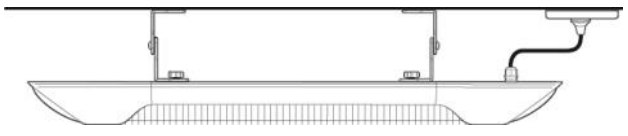
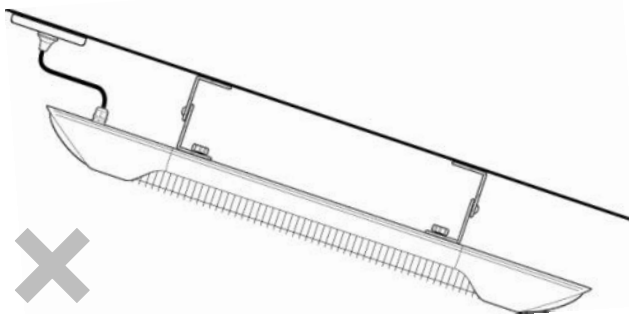
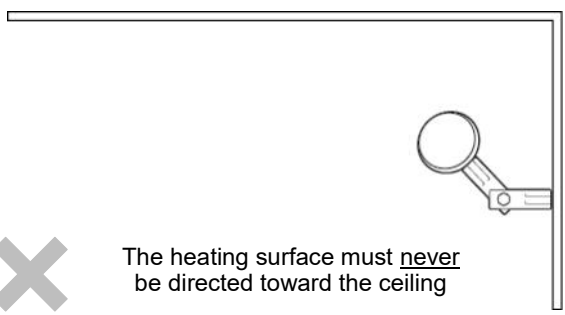
Incorrect Installation	Correct Installation
 <p>A cross-sectional diagram showing a HEATSTRIP Nano heater mounted on a ceiling. The heater is positioned such that its electrical connections are located directly behind the heating element. A large grey 'X' is placed to the left of the diagram.</p>	 <p>A cross-sectional diagram showing a HEATSTRIP Nano heater mounted on a ceiling. The heater is positioned such that its electrical connections are located outside the physical footprint of the unit. A large grey checkmark is placed to the left of the diagram.</p>
 <p>A diagram showing a HEATSTRIP Nano heater mounted on a wall that is angled upwards. The heater is mounted along the length of the wall. A large grey 'X' is placed to the left of the diagram.</p>	
 <p>A diagram showing a HEATSTRIP Nano heater mounted on a wall. The heater is positioned such that its heating surface is directed towards the ceiling. A large grey 'X' is placed to the left of the diagram.</p> <p>The heating surface must <u>never</u> be directed toward the ceiling</p>	

HEATSTRIP®

Installation location — the below diagrams confirm the minimum recommended clearances.

Angled Wall Installation

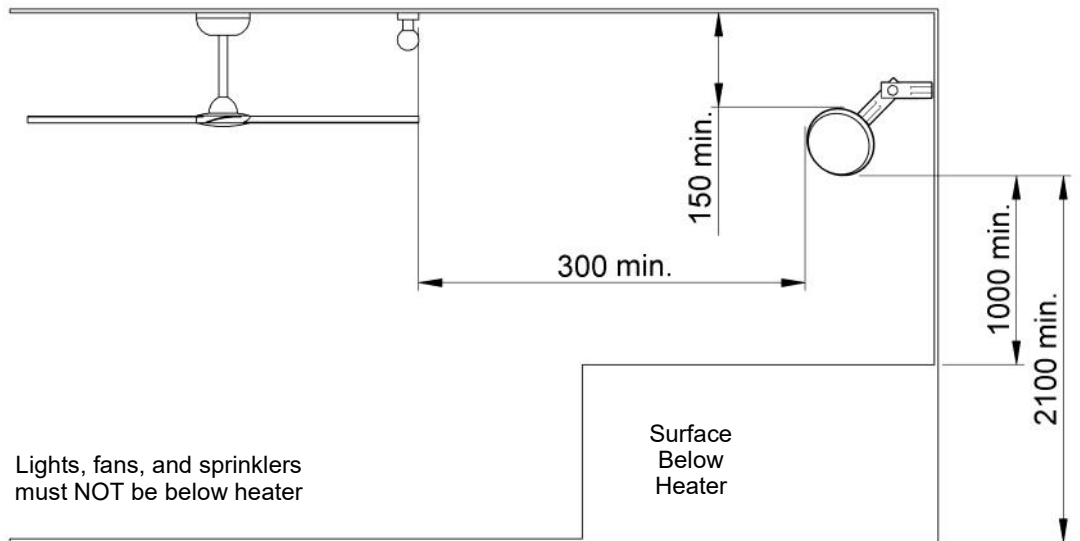

Ceiling Installation

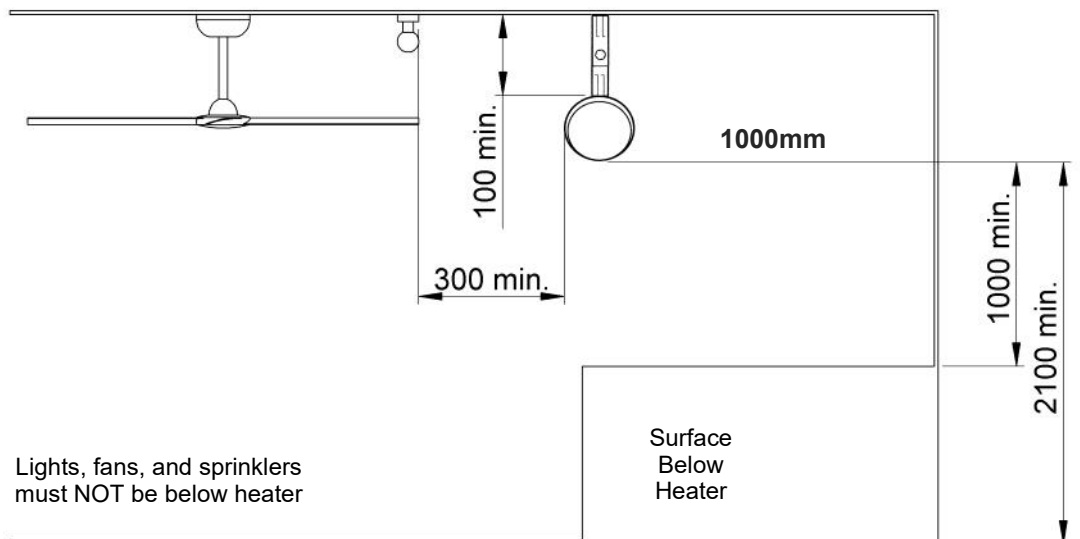

Angled Ceiling Installation

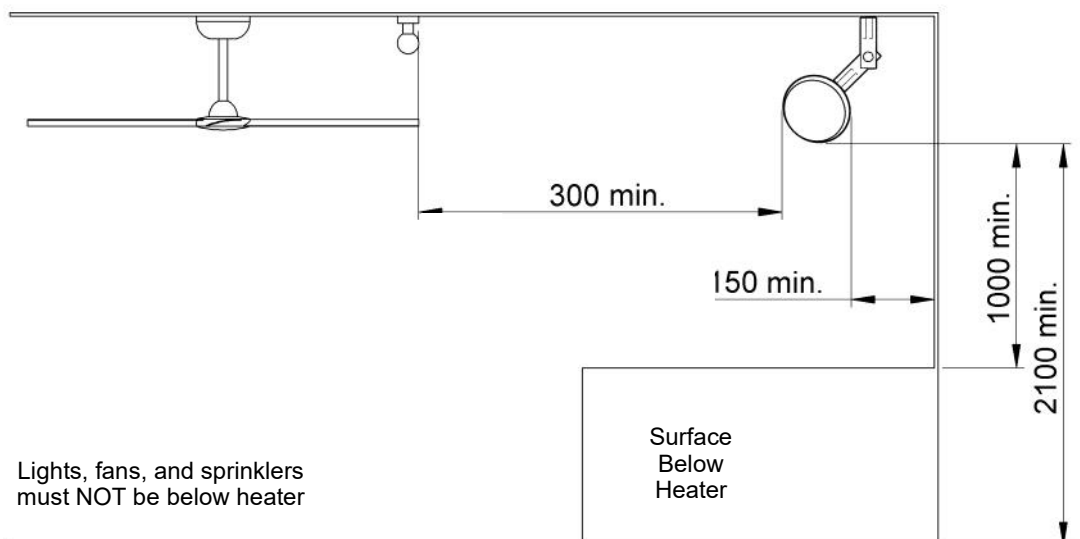

HEATSTRIP®

Standard mounting brackets

The HEATSTRIP® Nano comes with a pair of standard mounting brackets. These adjustable brackets allow direct ceiling or wall mount, and come with pre-set angle options of parallel, 22.5° and 45°.

The flexible standard mounting bracket can be turned 90 degrees to mount onto a beam, it can also be used to suspend with chains.

The brackets need to be mounted onto a secure frame or wall with a minimum distance between the two brackets. The minimum distance ("B") is listed on the next page. All dimensions shown below are in (mm).

When completing the installation, ensure all screws are tight and unit is secure.

Note: When suspension mounting, chains are not included.

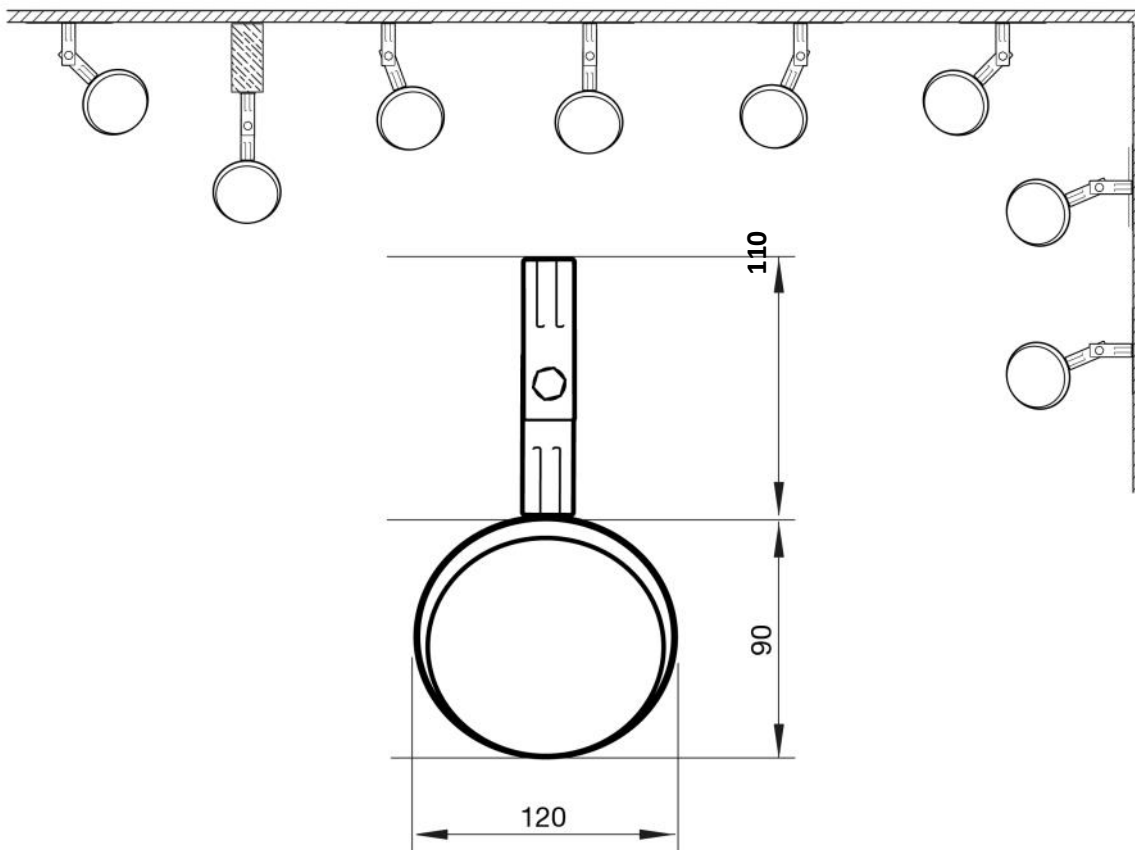

Standard Mounting Bracket

WEIGHT (kg)	MATERIALS
0.4	Stainless Steel

HEATSTRIP®

MOUNTING

Fix the two mounting brackets to the ceiling or wall in the desired location (refer minimum bracket centre chart). Make sure the method of fixing (bolts or screws) will be more than strong enough to support the weight of the heater, allowing for strong winds and other conditions.

- Slide the 2 locking brackets into the groove on the back of the heater. Make sure the pins on the locking bracket are facing the matching holes in the top mounting bracket.
- Lift heater into position and secure the 2 locking brackets to the mounting brackets using the screws provided. Make sure the 2 pins on the locking bracket engage with the matching holes in the mounting bracket. The pins will allow for both horizontal or angle mounting as required
- Tighten all screws and tighten the round nut at the top of the bracket, so it locks onto the top part of the mounting bracket.

NOTE: The standard bracket allows for normal or angle mounting of the heater and is suitable for ceiling or wall mounting.

MODEL	"B" MINIMUM DISTANCE (mm)
THN2000	490

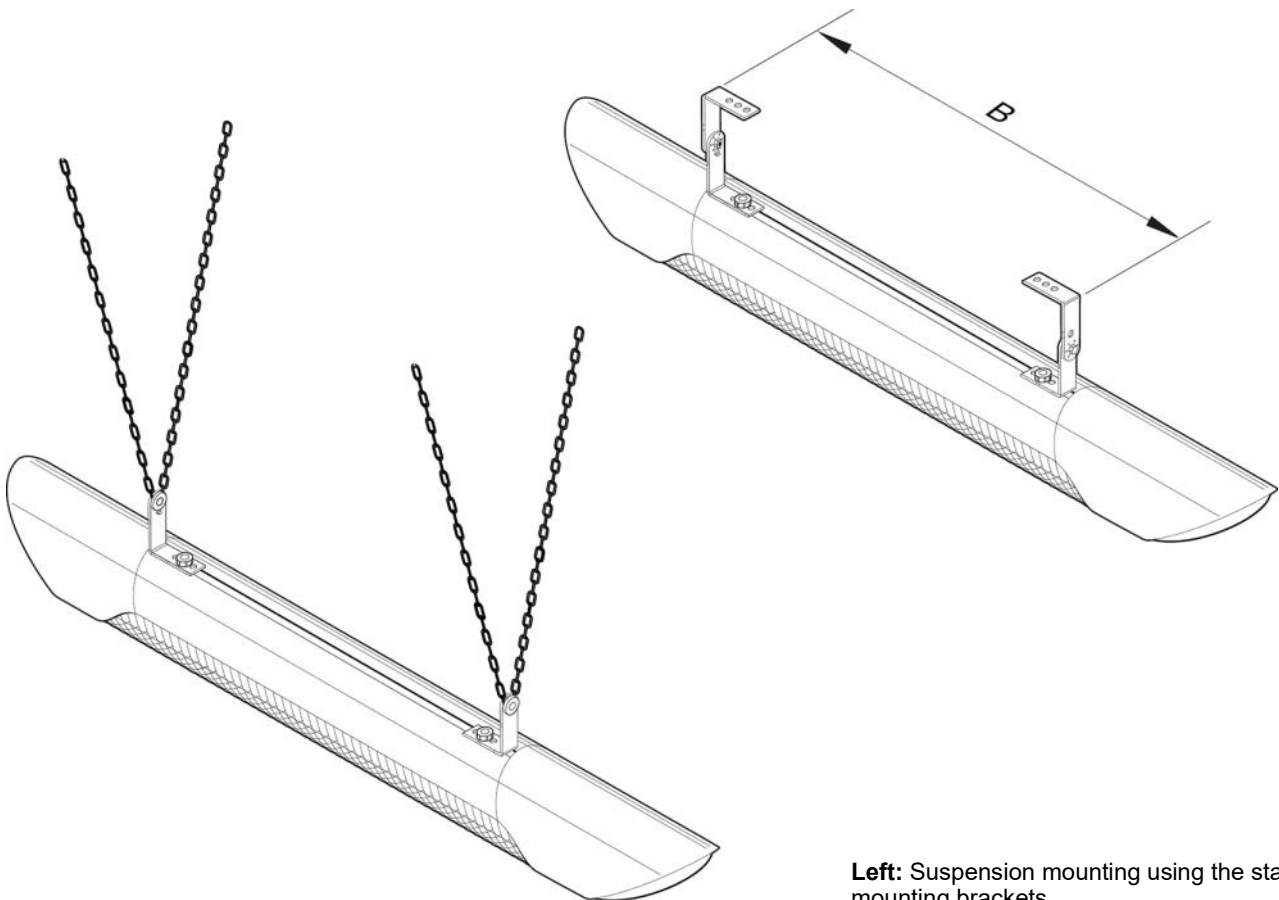

Left: Suspension mounting using the standard mounting brackets

NOTE: Chains or wire not included

HEATSTRIP[®]

REMOTE CONTROL OPERATION

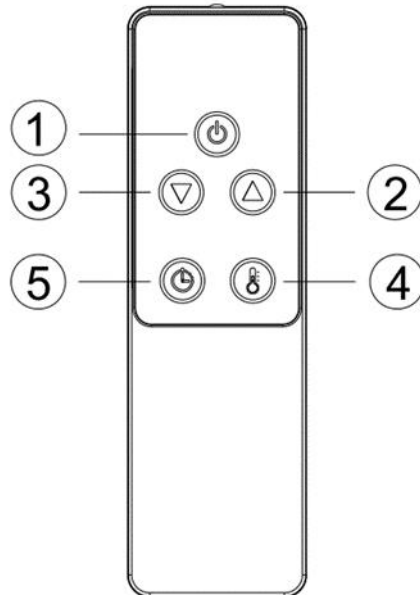

Remote Control Instructions

1. **POWER BUTTON:** Turn the heater On/Off.
2. **UP BUTTON:** Increase timer and heat level.
3. **DOWN BUTTON:** Decrease timer and heat level.
4. **HEAT LEVEL BUTTON:** Use to adjust the heat levels(L1-L4). Press the Heat Level button then use the up and down buttons (buttons 2 and 3) to increase or decrease the heating level.
5. **TIMER BUTTON:** To set the timer from 0H-24H, which is the number of hours it will run. 0H will display and then adjust to the number of hours you would like to set, using the up and down buttons(2 and 3).

Note: All HEATSTRIP Nano heaters and their remote controls have the same frequency, so it is possible to control several heaters with just one remote.

When using the heat levels, the wattage may vary between settings. L1 (800W), L2 (1200W), L3 (1600W) & L4 (2000W).

An isolation switch is located on the side of the heater. This must be switched to "ON" position (LED light illuminated) for the heater to operate.

HEATSTRIP[®]

Safety

HEATSTRIP[®] Nano has an IP rating of 55. This means it is safe for water ingress from all directions. The HEATSTRIP[®] can be safely hosed down.

HEATSTRIP[®] has undergone extensive testing both in laboratory conditions; in Thermofilm's facility in Melbourne and field trials in Australia and overseas. It has been this testing that gives the purchaser the confidence of a high quality product.

Independent laboratory testing has confirmed Thermofilm's full compliance with Australian and other International Standards. This includes CE, AS/ANZ, UL/CSE

HEATSTRIP[®] is Class 1 equipment and must be earthed.

In operation, this heater is VERY HOT— do not touch any part of the heater while it is turned on. Do not touch any part until 30 minutes after it is turned off.

This appliance is not intended for use by persons (including children) with reduced physical, sensory or intellectual capabilities, or lack of experience and knowledge, unless they have been given supervision or instruction concerning use of the appliance by a person responsible for their safety. Children should be supervised to ensure they do not play with the appliance.

Do not allow any cables, furnishings, flammable materials or other items come in contact with any surface of the heater.

If installed in wet areas, the heater switches or controls must be located so that they cannot be touched by persons in the bath or shower.

The heater needs to be installed as per the installation instructions paying special attention to the minimum clearances. The heater needs to be mounted on a rigid bracket or fixing.

The heater must not be mounted immediately below or in front of a socket outlet.

In case of a heater fault or damaged supply lead, the appliance should be returned to the point of purchase for return to Thermofilm for repair.

Maintenance

The HEATSTRIP[®] is made from durable materials, however regular care and maintenance of your heater will help prolong the life of the heater.

It is recommended that you hose down the heater and with a soft cloth gently wipe the surfaces of the heater with a mild detergent to remove the built up contaminants from the environment. Then rinse all detergent off the heater.

All chemicals in the atmosphere including cigarette smoke, pollution etc. will tarnish the surface of the heater. In this case, additional cleaning and maintenance may be required. The cleaning process at least every three months will reduce the amount of build up and keep it looking as best it can. If the heater is in a corrosive environment eg. salt spray, we recommend that you clean your heater with a light spray of fresh water every week. After cleaning, turn the heater on for 20 minutes to dry any water residue and prevent water staining.

Before cleaning or inspection activity, the heater must be switched off and cooled down completely.

Do not use any abrasive materials or products to clean the heater, this includes solvents, citrus based cleaners or other harsh cleaning products.

When handling the heater, ensure that your hands are clean or that you use clean gloves as grease or dirt can mark the surface of the heater.

Do not use high pressure water to clean heaters, light water spray only.

HEATSTRIP®

Warranty Terms & Conditions

The below Warranty Terms and Conditions apply for **New Zealand and Australia only**. For international warranty please refer to international warranty terms and conditions.

Thermofilm warrants to the original owner that HEATSTRIP® Nano products will be free from defects in materials and workmanship for a period of 18 months for residential applications (and 12 months for commercial applications) from the date of purchase in accordance with the following warranty terms and conditions.

Provision of this warranty is subject to:

- The HEATSTRIP® product must be installed in accordance with the Installation Instructions and relevant electrical standards and codes.
- The HEATSTRIP® product must be maintained and cleaned according to instructions detailed in the Installation Manual.
- There is no warranty expressed or implied with regard to capacity requirements. The selection of the unit or units depends entirely upon the system design and capacities as determined by the purchaser.
- The customer has not repaired, opened or altered the product in any unauthorised manner.
- This warranty excludes damage to the product or components arising from circumstances outside the control of Thermofilm, including, but not limited to, where the product is not used for intended purpose; where the product has been rectified in any way; incorrect installation; incorrect power supply; damaged caused during delivery; misapplication, misuse, abuse, vandalism, lack of maintenance or accident.
- Thermofilm's obligations under this warranty are limited to repair or replacement at Thermofilm's factory of any components of the product which Thermofilm identifies to its satisfaction to be defective.
- Transportation charges involved in return of the product to the Thermofilm factory (or any other location authorised in writing by Thermofilm) is the sole responsibility of the customer.
- All products are inspected and tested before despatch and are at the risk of the purchaser after the shipment from the Thermofilm factory, if not delivered by Thermofilm to destination.
- Discolouration of the surface may occur after a period of time, this does not constitute a warrantable event.
- Twisting and bending of the heaters may occur, this does not constitute a warrantable event.
- No products or components will be supplied in advance of an examination of the faulty product or components by Thermofilm or an authorized representative of Thermofilm.
- Thermofilm does not participate in any site related costs or labour expenses incidental to replacement of parts, repairing, removing, installing, servicing, transportation or handling of parts to complete products, and assumes no liability on parts repaired or replaced without written authorisation. Thermofilm shall not be liable for any default or delay in performance of its warranty obligations caused by any circumstances beyond its control, including, but not limited to, judicial or government restrictions, strikes, fires, floods, abnormal weather conditions, delayed supply of components.

Should products be determined as damaged on arrival, immediately notify the transport company of the condition and have them noted on the freight documents. If damage is discovered after unpacking, demand immediate inspection by the transportation company and insist that a record of the damage is made on the freight documentation.

The customer warrants using the product in accordance with:

- Any instructions provided to it by Thermofilm from time to time.
- All government and local regulations, including but not limited to all relevant electrical, environmental laws and regulations governing the installation, storage, use, handling and maintenance of the goods.
- All necessary and appropriate precautions and safety measures relating to the installation, storage, use, handling and maintenance of goods.

Our goods come with guarantees that cannot be excluded under the Australian Consumer Law. You are entitled to a replacement or refund for a major failure and for compensation for any other reasonably foreseeable loss or damage. You are also entitled to have the goods repaired or replaced if the goods fail to be of acceptable quality and the failure does not amount to a major failure.

All warranty requests for repairs or replacements must be accompanied by a complete "Warranty Claim Form" available from Thermofilm, together with proof of purchase (and where possible, photos of the installation) and the heater returned to the place of purchase.

In the event of a warranty claim, the goods need to be returned to the distributor/retailer for repair/replacement. Contact

Thermofilm Australia Pty Ltd
17 Johnston Court, Dandenong South, Victoria 3175, Australia
Telephone: (03) 9562 3455,
Email: info@thermofilm.com.au